



**DEVELOPMENT OF A NEW BIOANALYTICAL
METHOD FOR MASS SPECTROMETRIC
ANALYSIS OF GLYCOPEPTIDES USING
HYDROPHILIC INTERACTION-BASED
SORBENTS**

**2022
MASTER THESIS
BIOMEDICAL ENGINEERING**

Abdulbaset Ramadan ALTOUMI

**Thesis Advisor
Assoc.Prof.Dr. Hacı Mehmet KAYILI**

**DEVELOPMENT OF A NEW BIOANALYTICAL METHOD FOR MASS
SPECTROMETRIC ANALYSIS OF GLYCOPEPTIDES USING
HYDROPHILIC INTERACTION-BASED SORBENTS**

Abdulbaset Ramadan ALTOUMI

**T.C.
Karabuk University
Institute of Graduate Programs
Department of Biomedical Engineering
Prepared as
Master Thesis**

**Thesis Advisor
Assoc. Prof. Dr. Hacı Mehmet KAYILI**

**KARABUK
September 2022**

I certify that in my opinion the thesis submitted by Abdulbaset Ramadan ALTOUMI titled “DEVELOPMENT OF A NEW BIOANALYTICAL METHOD FOR MASS SPECTROMETRIC ANALYSIS OF GLYCOPEPTIDES USING HYDROPHILIC INTERACTION-BASED SORBENTS” is fully adequate in scope and in quality as a thesis for the degree of Master of Science.

Assoc. Prof. Dr. Hacı Mehmet KAYILI
Thesis Advisor, Department of Biomedical Engineering

Prof. Dr. Bekir SALİH
Second Thesis Advisor, Department of Chemistry

This thesis is accepted by the examining committee with a unanimous vote in the Department of Biomedical Engineering as a Master of Science thesis. Sep 16, 2022

Examining Committee Members (Institutions) Signature

Chairman : Prof. Dr. Bekir Salih (HU)

Member : Assoc. Prof. Dr. Hacı Mehmet KAYILI (KBU)

Member : Assist. Prof. Dr. Hakan YILMAZ (KBU)

Member : Assist. Prof. Dr. Mehmet Atakay (HU)

Member : Assist. Prof. Dr. Ahmet Reşit KAVSAOĞLU (KBU)

The degree of Master of Science by the thesis submitted is approved by the Administrative Board of the Institute of Graduate Programs, Karabuk University.

Prof. Dr. Hasan SOLMAZ
Director of the Institute of Graduate Programs



“I declare that all the information within this thesis has been gathered and presented in accordance with academic regulations and ethical principles and I have according to the requirements of these regulations and principles cited all those which do not originate in this work as well.”

Abdulbaset Ramadan ALTOUMI

ABSTRACT

M. Sc. Thesis

DEVELOPMENT OF A NEW BIOANALYTICAL METHOD FOR MASS SPECTROMETRIC ANALYSIS OF GLYCOPEPTIDES USING HYDROPHILIC INTERACTION-BASED SORBENTS

Abdulbaset Ramadan ALTOUMI

Karabük University

Institute of Graduate Programs

The Department of Biomedical Engineering

Thesis Advisor:

Assoc. Prof. Dr. Hacı Mehmet KAYILI

September 2022, 49 pages

Glycosylation process is a post-translational modification with essential functions for the living proteome. Monitoring of proteins undergoing this modification is very important for the preliminary diagnosis of various diseases. However, the analysis of glycoproteins subjected to this modification presents multiple difficulties. The number of ordinary peptides belonging to glycopeptides are usually very high compared to glycopeptides. This causes suppression of the mass spectrometric signals of the glycopeptides. Therefore, glycopeptides are needed to be enriched for efficient analysis. Sorbents based on hydrophilic interaction (HILIC) are frequently used for the enrichment of glycopeptides because they are inexpensive and easy to apply. In this thesis, a pipette tip application was developed by using HILIC-based sorbents together with cotton wool. Commercially available cellulose and sepharose CL-4B sorbents were used in the study. These sorbents were placed on the pipette tips, and their

performance in the enrichment of glycopeptides was tested. First, the optimal elution and loading conditions for glycopeptides were tested, and it was determined that 85% ACN with 1% TFA for loading and 100% H₂O for elution were the optimum conditions for both selectivity and detection rate. Pipette tips containing HILIC-sorbent were used to enrich the glycopeptides of human plasma, and it was determined that the pipette tip containing cellulose and cotton thread had the highest N-glycopeptide identification rate. However, an increase in the number of ordinary peptides detected was detected when the cotton wool was used in combination with other HILIC sorbents. As a result of the studies, cotton wool and other HILIC-based sorbents increased the number of N-glycopeptides identified, especially when enrichment was made on complex samples. The results from this study are expected to contribute to the literature regarding site-specific clinical glycosylation analysis.

Key Words: glycosylation, hydrophilic interaction chromatography, enrichment of glycopeptides, glycoproteomics

Science Code : 20104

ÖZET

Yüksek Lisans Tezi

HİDROFİLİK ETKİLEŞİME DAYALI SORBENTLER KULLANILARAK GLİKOPEPTİTLERİN KÜTLE SPEKTROMETRİK ANALİZİ İÇİN YENİ BİR BİYOANALİTİK YÖNTEMİN GELİŞTİRİLMESİ

Abdulbaset Ramadan ALTOUMI

Karabük Üniversitesi

Fen Bilimleri Enstitüsü

Biyomedikal Mühendisliği Anabilim Dalı

Tez Danışmanı:

Dr. Öğr. Üyesi Hacı Mehmet KAYILI

Eylül 2022, 49 sayfa

Glikozilasyon canlı proteomu için önemli işlevleri bulunan bir post-translasyonel modifikasyondur. Bu modifikasyona uğrayan proteinlerin izlenmesi çeşitli hastalıkların ön tanısının koyulması için çok önemlidir. Fakat bu modifikasyona uğrayan glikoproteinlere ait glikoptitlerin analizler çeşitli zorluklar içermektedir. Glikopeptitlere ait sıradan peptitlerin miktarı genellikle glikopeptitlere göre çok yüksektir. Bu, glikopeptitlerin kütle spektrometrik sinyallerinin baskılanmasına sebep olmaktadır. Bu nedenle glikopeptitlerin verimli analizleri için zenginleştirilmelerine ihtiyaç vardır. Hidrofilik etkileşime (HILIC) dayalı sorbentler ucuz ve kolay uygulanabilir olmaları nedeni ile glikopeptitlerin zenginleştirilmelerinde sıklıkla kullanılmaktadır. Bu tez kapsamında HILIC temelli sorbentler pamuk ipliği ile birlikte kullanılarak bir pipet ucu uygulaması geliştirilmiştir. Çalışmada ticari olarak edinebilen selüloz ve sefaroz CL-4B sorbentleri kullanılmıştır. Bu sorbentler pipet

uçlarına yerleştirilerek glikopeptitlerin zenginleştirilmelerindeki performansları test edilmiştir. İlk olarak, glikopeptitler için en uygun elüsyon ve yükleme koşulları test edilmiş ve elüsyon için %100 H₂O ve yükleme için de %1 TFA içeren %85 ACN'nin hem seçicilik hem de tanımlama oranı bakımından en optimum koşullar olduğu belirlenmiştir. HILIC-sorbent içeren pipet uçları insan plazmasına ait glikopeptitlerin zenginleştirilmesi için kullanılmış ve selüloz ve pamuk ipliği içeren pipet ucunun en yüksek N-glikopeptit tanımlama oranına sahip olduğu belirlenmiştir. Bununla birlikte, pamuk ipliği, diğer HILIC-sorbentlerle birlikte kullanıldığında tespit edilen sıradan peptitlerin miktarında artış tespit edilmiştir. Yapılan çalışmalar sonucunda özellikle kompleks örnekler üzerine zenginleştirme yapıldığında pamuk ipliği ile birlikte diğer HILIC temelli sorbentlerin kullanılması N-glikopeptitlerin tanımlanma sayılarını artırmıştır. Bu çalışmadan elde edilen sonuçların bölgeye-özümlü kliniksel glikozilasyon analizleri açısından literatüre katkı sunması beklenmektedir.

Anahtar Kelimeler : glikozilasyon, hidrofilik etkileşim kromatografisi, glikopeptitlerin zenginleştirilmesi, glikoproteomik

Bilim Kodu : 20104

ACKNOWLEDGMENT

I would like to express my gratitude to my primary thesis advisor, Assist. Prof. Dr. Hacı Mehmet KAYILI, who guided and helped me throughout this project. Finally I would like to thank my family and friends who supported me during the study.



CONTENTS

	<u>Page</u>
APPROVAL.....	ii
ABSTRACT.....	iv
ÖZET.....	vi
ACKNOWLEDGMENT.....	viii
CONTENTS.....	ix
LIST OF FIGURES	xii
LIST OF TABLES	xiv
SYMBOLS AND ABBREVIATIONS INDEX	xv
PART 1	1
INTRODUCTION	1
PART 2	4
LITERATURE REVIEW.....	4
2.1. GLYCOSYLATION	4
2.1.1. Types of Glycosylation.....	4
2.2. GLYCOSYLATION AND DISEASES	5
2.3. MASS SPECTROMETRY.....	5
2.3.1. Ionization Techniques.....	7
2.3.1.1. MALDI	7
2.3.1.2. Electrospray ionization (ESI).....	9
2.3.2. Mass Analyzers.....	10
2.3.2.1. Quadrupole Analyzer	11
2.3.2.2. Time of Flight (TOF).....	12
2.3.2.3. Orbitrap	14
2.4. MASS SPECTROMETRY BASED GLYCOSYLATION ANALYSIS	16
2.4.1. Enrichment of Glycopeptides	16
2.4.2. MALDI-MS Analysis of Glycopeptides.....	17

	<u>Page</u>
2.4.3. ESI-MS/MS Analysis of Glycopeptides	18
2.5. STAGE-TIP APPLICATIONS FOR GLYCOPROTEOMICS	19
2.5.1. Cancer	20
2.5.2. Neurodegenerative Diseases and Neurobiology	20
2.5.3. Other Applications	21
PART 3	22
MATERIALS AND METHODS	22
3.1. MATERIALS	22
3.2. PROTEOLYTIC DIGESTION OF IGG AND HUMAN PLASMA GLYCOPROTEINS	22
3.3. PREPARATION OF THE COTTON CONTAINING STAGE-TIP	22
3.4. ENRICHMENT OF GLYCOPEPTIDES USING HILIC-SORBENT CONTAINING STAGE-TIPS	23
3.5. MALDI-MS ANALYSIS	24
3.6. NLC-MS/MS ANALYSIS	25
PART 4	26
RESULTS AND DISCUSSION	26
4.1. COMPARISON OF DIFFERENT ELUTION CONDITIONS FOR THE ENRICHMENT OF IGG <i>N</i> -GLYCOPEPTIDES	27
4.2. COMPARISON OF DIFFERENT LOADING CONDITIONS FOR THE ENRICHMENT OF IGG <i>N</i> -GLYCOPEPTIDES	30
4.3. COMPARISON OF SELECTIVITY OF HILIC-SORBENTS CONTAINING STAGE TIPS IN DIFFERENT LOADING CONDITIONS FOR THE ENRICHMENT OF IGG <i>N</i> -GLYCOPEPTIDES	31
4.4. DETERMINATION OF THE SENSITIVITY OF DIFFERENT HILIC- SORBENT CONTAINING STAGE-TIPS	32
4.5. EVALUATION OF THE PERFORMANCE OF HILIC SORBENT CONTAINING STAGE TIPS USED FOR THE ENRICHMENT OF GLYCOPEPTIDES FROM REAL-WORLD SAMPLES	34
PART 5	36
CONCLUSION	36
REFERENCES	37

	<u>Page</u>
APPENDIX A.....	41
MALDI-MS SPECTRA FIGURES	41



LIST OF FIGURES

	<u>Page</u>
Figure 2.1. MS instrument components [12].	6
Figure 2.2. Ionization of analytes by MALDI [15].	8
Figure 2.3. ESI steps [13].	9
Figure 2.4. Quadrupole mass analyzer [18].	12
Figure 2.5. ToF mass analyzer a) conventional ToF, b) reflectron-type ToF [18].	14
Figure 2.6. Orbitrap analyzer [19].	15
Figure 2.7. The basic components of the ESI-mass spectrometer [24].	18
Figure 2.8. Mass spectrum.	19
Figure 3.1. A microcentrifuge tube with a HILIC stage tip.	23
Figure 4.1. An illustration of used stage-tips used in the study.	26
Figure 4.2. MALDI-MS spectrum of IgG <i>N</i> -glycopeptides.	27
Figure 4.3. The detected IgG <i>N</i> -glycopeptides after enrichment using different HILIC sorbents containing stage tips from three elution conditions.	29
Figure 4.4. The number of detected IgG <i>N</i> -glycopeptides after enrichment using different HILIC sorbents containing stage tips from five loading conditions.	31
Figure 4.5. The number of detected ordinary peptides in different loading conditions for HILIC-sorbents containing stage-tips.	32
Figure 4.6. The number of detected IgG <i>N</i> -glycopeptides used in various amounts of IgG digests.	33
Figure 4.7. The number of detected human plasma <i>N</i> -glycopeptides and ordinary peptides when different HILIC-sorbent-based stage-tips were used for the enrichment.	35
Figure Appendix A.1. MALDI-MS spectra of IgG <i>N</i> -glycopeptides after applied enrichment protocol with cotton stage tips in different elution conditions A) 100% H ₂ O, B) 90% H ₂ O 10% ACN, and C) 80% H ₂ O 20% ACN.	42
Figure Appendix A.2. MALDI-MS spectra of IgG <i>N</i> -glycopeptides after applied enrichment protocol with cotton + cellulose stage tips in different elution conditions A) 100% H ₂ O, B) 90% H ₂ O 10% ACN, and C) 80% H ₂ O 20% ACN.	42
Figure Appendix A.3. MALDI-MS spectra of IgG <i>N</i> -glycopeptides after applied enrichment protocol with cotton + sepharose CL-4B stage tips in different elution conditions A) 100% H ₂ O, B) 90% H ₂ O 10% ACN, and C) 80% H ₂ O 20% ACN.	43

Figure Appendix A.4. MALDI-MS spectra of IgG *N*-glycopeptides after applied enrichment protocol with cotton + cellulose + sepharose CL-4B stage tips in different elution conditions A) 100% H₂O, B) 90% H₂O 10% ACN, and C) 80% H₂O 20% ACN. 43

Figure Appendix A.5. MALDI-MS spectra of IgG *N*-glycopeptides after applied enrichment protocol with cotton stage tips in different loading conditions A) 85% ACN 1% TFA, B) 85% ACN 2% TFA, C) 85% ACN 3% TFA, D) 85% ACN 4% TFA, and E) 85% ACN 5% TFA. 44

Figure Appendix A.6. MALDI-MS spectra of IgG *N*-glycopeptides after applied enrichment protocol with cotton + cellulose stage tips in different loading conditions A) 85% ACN 1% TFA, B) 85% ACN 2% TFA, C) 85% ACN 3% TFA, D) 85% ACN 4% TFA, and E) 85% ACN 5% TFA. 45

Figure Appendix A.7. MALDI-MS spectra of IgG *N*-glycopeptides after applied enrichment protocol with cotton + sepharose CL-4B stage tips in different loading conditions A) 85% ACN 1% TFA, B) 85% ACN 2% TFA, C) 85% ACN 3% TFA, D) 85% ACN 4% TFA, and E) 85% ACN 5% TFA. 46

Figure Appendix A.8. MALDI-MS spectra of IgG *N*-glycopeptides after applied enrichment protocol with cotton + cellulose + sepharose CL-4B stage tips in different loading conditions A) 85% ACN 1% TFA, B) 85% ACN 2% TFA, C) 85% ACN 3% TFA, D) 85% ACN 4% TFA, and E) 85% ACN 5% TFA. 47

Figure Appendix A.9. MALDI-MS spectra of IgG *N*-glycopeptides after applied enrichment protocol with cotton stage tips using different IgG digests A) 0.1 µg, B) 0.5 µg, C) 1.0 µg, and D) 2.5 µg. 48

Figure Appendix A.10. MALDI-MS spectra of IgG *N*-glycopeptides after applied enrichment protocol with cotton + cellulose stage tips using different IgG digests A) 0.1 µg, B) 0.5 µg, C) 1.0 µg, and D) 2.5 µg. 48

Figure Appendix A.11. MALDI-MS spectra of IgG *N*-glycopeptides after applied enrichment protocol with cotton + sepharose CL-4B stage tips using different IgG digests A) 0.1 µg, B) 0.5 µg, C) 1.0 µg, and D) 2.5 µg. 49

Figure Appendix A.12. MALDI-MS spectra of IgG *N*-glycopeptides after applied enrichment protocol with cotton + cellulose + sepharose CL-4B stage tips using different IgG digests A) 0.1 µg, B) 0.5 µg, C) 1.0 µg, and D) 2.5 µg. 49

LIST OF TABLES

	<u>Page</u>
Table 4.1. The elution solvents used in the study.	27
Table 4.2. A list of the <i>N</i> -glycopeptides of IgG.	28
Table 4.3. The loading solvents used in the study.	30



SYMBOLS AND ABBREVIATIONS INDEX

SYMBOLS

NHS : N-hydroxysuccinimide groups.

The : Threonine.

ACN : Acetonitrile.

APTS : (3-Aminopropyl)triethoxysilane.

ABC : Ammonium bicarbonate.

Ser : Serine.

ABBREVIATIONS

MS : Mass Spectrometry.

QbD : Quality by Design.

TOF : Time of Flight.

CDC : Complement-dependent cytotoxicity.

QTOF : Quadrupole Time of Flight.

ESI : Electrospray ionization.

APPI : Atmospheric Pressure Photoionization.

MALDI : Matrix-Assisted Laser Desorption/Ionization.

FDA : Food and Drug Administration.

ADCC : Antibody-dependent cellular cytotoxicity.

GC-EI : Gas Chromatography – Electron Ionization.

FWHM : Full-Width Half-Maximum.

DNA : Deoxyribonucleic Acid.

AP/LIAD-CI : Atmospheric Pressure Laser-induced Acoustic Desorption Chemical Ionization.

3D : Three Dimensional.

HIV : Human Immunodeficiency Virus.
HILIC : Hydrophilic Interaction Chromatography.
HPLC : High-Performance Liquid Chromatography.
PAD : Pulsed Amperometric detection.
HPAEC : High pH Anion Exchange Chromatography.



PART 1

INTRODUCTION

Glycosylation is the process of producing a glycoconjugate by covalently bonding a carbohydrate or a glycosyl donor known as 'glycan' to a target macromolecule (a glycosyl acceptor), commonly proteins and lipids. This adjustment offers several benefits [1]. For example, some proteins need to be glycosylated in order to fold correctly [2]. In other conditions, oligosaccharides connected to the amide nitrogen of particular asparagine residues are required for protein stability. Glycans linked to proteins give crucial structural and functional features, and glycan particles of glycoproteins play critical functions in a variety of biological processes. Glycation usually refers to a non-enzymatic reaction in biology, whereas glycosylation commonly refers to an enzyme-catalyzed response [3]. Glycosylation is a type of post-translational modification that occurs throughout the translation process. In a membrane and secreted proteins, glycans have a variety of structural and functional roles [2]. Glycosylation occurs on the majority of proteins produced in the rough endoplasmic reticulum. The O-GlcNAc modification of glycosylation can also be found in the cytoplasm and nucleus [4,5]. Glycosylation also aids cell-to-cell adhesion (a technique immune system cells employ) by allowing sugar-binding proteins known as lectins to detect specific carbohydrate moieties [2]. Many glycoprotein-based medications, such as monoclonal antibodies, include glycosylation as a crucial parameter in their optimization. Glycosylation can serve a variety of purposes. Folding, stabilization, packing, trafficking, quaternary structure, protease protection, and water structure organization are physical features. Weak interactions, multiple presentations, and exact geometry are characteristics of recognition and biological triggering properties [2].

Glycosylation is an effective process that relies on the local medium of enzymes, organelle structures and sugar precursors in addition to the cell types involved and

cellular signals. The biological significance of the glycome was originally brought to light by studies of rare genetic disorders that affect glycosylation, and technological advancements have improved our understanding of its complexity and heterogeneity. These days' scientists can estimate how secreted glycome reflects the cellular state in disease and health. The glycome composition also influences kidney functioning in health and illness; changes in glycosylation can influence inflammatory responses, increase cancer cell metastasis, allow viral immune escape, or regulate apoptosis. Now, new understandings of the function and structure of the glycome can be used to build treatments. They might stimulate immune responses to cancer cells, enhance the effectiveness of therapeutic antibodies, and enhance our capacity to control inflammatory and immunological responses. These examples show the potential of the promising field of "glycomedicine" [6].

In order to understand the site-specific glycan alterations of glycoproteins, a method called glycoproteomic analysis of glycopeptides has recently been devised. A quick way to enrich intact glycopeptides is necessary for analyzing glycoproteins, particularly for biopharmaceutical proteins. In one of the recent studies, researchers established a one-step technique for rapidly capturing intact glycopeptides for analysis using mass spectrometry. The proposed one-step enrichment method reduced sample preparation time while improving the detection of intact glycopeptides with long sequences or non-polar amino acids compared to the conventional sequential enrichment method. Furthermore, compared to the traditional sequential method, the suggested one-step method detected more peptides containing glycosite [7].

Due to its success in separating water-soluble chemicals, hydrophilic interaction chromatography (HILIC) has attracted a lot of attention lately. HILIC is a type of normal-phase liquid chromatography (NPLC). The water-enriched layer on the surface of the highly polar stationary phase and less polar mobile phase is what causes the separation process, it consist of a polar solvent containing water such as acetonitrile (ACN). Although the primary separation mechanism is based on NPLC, the separation of water-soluble compounds is also influenced by secondary effect interactions such as electrostatic interaction, dipole-dipole interaction, and hydrogen bond. Although using the HILIC mode in solid-phase extraction (SPE) might in theory help with the

extraction and purification of many water-soluble chemicals. Few studies discussed their practical implementation for water-soluble substances, such as glycopeptides and peptides. This is probably because there aren't as many HILIC-type SPE sorbents on the market as there are RP-type SPE sorbents. Commercially, NH₂- and Amide-type SPE sorbents are offered as HILIC-type SPE sorbents. Furthermore, while there are much more published studies on HILIC-type SPE for HPLC applications, there are few studies that concentrated on the development and enlargement of sorbents for HILIC-type SPE. Due to this, the only way to carry out good quantitative analysis of water-soluble chemicals is to create HILIC-type sorbents for SPE applications [8].

This study aims to develop a suitable method for HILIC-sorbents containing stage tips for the enrichment of glycopeptides. In addition, it is targeted to compare the enrichment performance of HILIC-sorbents when they are used with cotton wool. The method was optimized by using IgG digests. In addition, human plasma was used to test *N*-glycopeptides' enrichment performance.

PART 2

LITERATURE REVIEW

2.1. GLYCOSYLATION

Glycans, which are covalent bonds of saccharides that are frequently connected to proteins and lipids, represent a large portion of the mass and structural variety in biological systems. The science of glycans and their derivatives' structure, chemistry, biosynthesis, and biological function is the focus of glycobiology. Glycobiology has a lengthy history, dating back to studies of cell contents and the nature of the polysaccharide carbohydrate component. Glycosylation is a necessary process that happens in each the endoplasmic reticulum and also the histologist apparatus. it's primarily a kind of post-translational modification liable for manufacturing a practical macromolecule from associate degree immature protein. Therefore, glycosylation facilitates correct folding and will increase protein stability. For instance, glycosylation is a compound intervened process. In this manner, a characterized sugar of a protein is added to a foreordained district. Additionally, the glycosylation interaction can be controlled by directing the activity of the protein [9].

2.1.1. Types of Glycosylation

During glycosylation, the carbonyl gathering (glycosyl benefactor) of a sugar responds with the hydroxyl or amine bunch (glycosyl acceptor) of the protein. Different kinds of glycosylation happen in the cell [10]. There are several types of glycosylation:

1- N-linked glycosylation - glycans attached to a nitrogen of an asparagine or arginine side chains.

2- O-linked glycosylation is the binding of a sugar molecule to the oxygen molecule of serine or threonine.

3- Phosphoserine glycosylation - phosphoglycans including mannose, xylose, or fucose bound from a phosphoserine phosphate.

4- C-manosylation - sugar is added to a carbon on a tryptophan side chain.

5- Glypiation - Addition of a GPI anchor that connects proteins to lipids via glycan linkages.

2.2. GLYCOSYLATION AND DISEASES

Intrinsic issues of glycosylation (CDG) are an immense gathering of hereditary sicknesses coming about because of deformities and issues in the blend of glycans and in the connection of glycans to different mixtures. There are 40 types of CDG that have been discovered. CDGs by and large impact all frameworks and specifically the focal sensory system, except for CDG - Ib, which is mostly a hepatic-gastrointestinal illness. CDGs should be kept in basically by the pediatricians in the differential analysis of the patients with unexplained neurologic discoveries (psychomotor retardation, cerebellar, convulsion, hyporeflexia, hypoplasia, hypotonia), cholestasis, coagulopathy, failure to thrive, liver function disorders, ocular disorders and skeletal involvement [11].

2.3. MASS SPECTROMETRY

Mass spectrometry (MS) is a chemical analytical method which uses ionization and mass analysis of substances to determine their mass, formula, and structure [12].

Figure 2.1 shows the main components of MS instrument.

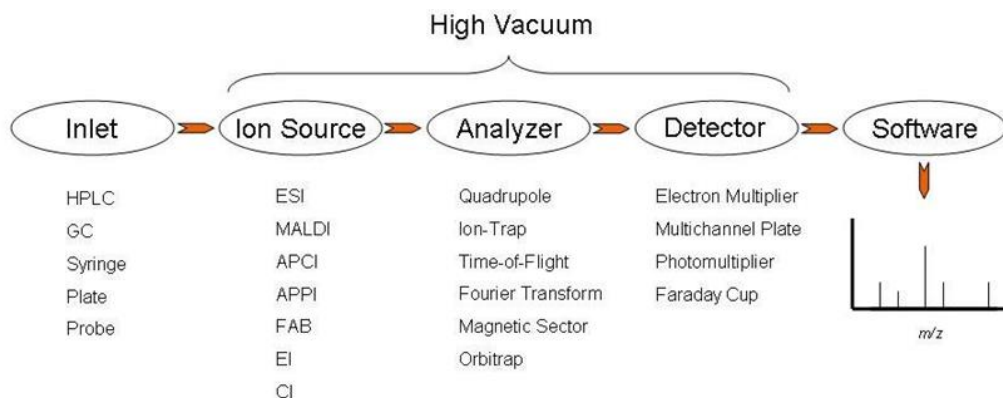

Figure 2.1. MS instrument components [12].

There are various kinds of mass spectrometers, yet assorted types have three principal parts (Particle source, analyzer, and the indicator).

Particle Source: The atoms in the example are ionized straightforwardly or by implication by a flood of electrons moving from a warmed fiber to the anode (both positive and negative particles are shaped by ionization, yet sure ones prevail, and scientific strategies essentially depend on certain particles). With the little regrettable potential in the cut, the positive particles are isolated from the negatives. The potential of several hundred accelerates them to several thousand volts between A and B. A parallelized beam of positive ions enters the separation zone from slit B [13].

Mass Analyzer: Fast moving in the analyzer tube kept under 10^{-7} torr, pressure ions enter into a strong magnetic field and draw a curved path under the influence of the field. The curve (diameter of the curve) of the path changes according to the strength of the magnetic field, the velocity, and the mass of the ions. By changing the acceleration potential or field strength, particles with different masses are focused on the exit slit [13].

Finder: counting the quantity of particles of a particular m/z esteem going through the leave cut fall on a gathering cathode, and a particle current is framed [13].

2.3.1. Ionization Techniques

With such countless different sorts of particle sources, ionization components and different kinds of mass analyzers, there are a few kinds of ionization sources and mass analyzers that are superb fits with each other, and these incorporate the most usually accessible business instruments. There are numerous strategies fit to various example types and applications. These can be separated into gas stage techniques, desorption strategies, and shower techniques [14]. There are several ionization technique types:

- 1- Gas phase methods
 - a. Direct analysis in real time (DART).
 - b. Electron ionization (EI).
 - c. Inductively coupled plasma (ICP).
 - d. Chemical ionization (CI).
- 2- Desorption methods
 - a. Liquid metal ion sources (LMIS).
 - b. Matrix assisted laser desorption ionization (MALDI).
 - c. Fast atom bombardment (FAB).
- 3- Spray methods
 - a. Desorption electrospray ionization (DESI).
 - b. Electrospray ionization (ESI).

2.3.1.1. MALDI

MALDI is a delicate ionization technique utilized in mass spectrometry that quickly and effectively ionizes a wide range of compounds. With little fragmentation, MALDI uses a matrix that absorbs laser energy to create ions from molecules with molecular weights between 100 and 1000 Daltons. Over the past 30 years, it has seen an increase in use, particularly for studying biomolecules, including DNA, proteins, peptides, and polysaccharides, as well as other large organic compounds like dendrimers, polymers, and other macromolecules. These molecules frequently fragmented when ionized by more traditional techniques because they are brittle, Figure 2.2 depicts the general principle of MALDI [15,16].

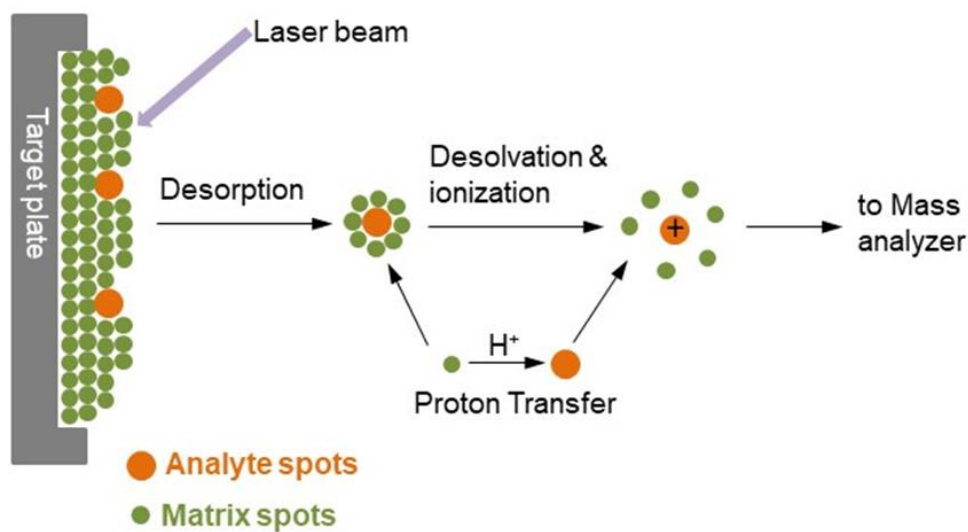

Figure 2.2. Ionization of analytes by MALDI [15].

The principle of MALDI

As shown in Figure 2.2, MALDI is a three-step process; the analyte is lodged in a massive excess of a matrix compound saved on a strong surface known as an objective. The objective is regularly developed of directing metal and has regions where different examples can be set. The illuminated spot is quickly warmed and becomes vibrationally invigorated following a short laser beat. As well as retaining the laser energy, the lattice atoms that were vigorously removed from the example's surface additionally conveyed the analyte particles into the gas stage. The analyte molecules are typically ionized by protonating or deprotonating with the surrounding matrix molecules during the ablation process. One positive charge per analyte molecule is the most typical MALDI ionization configuration [15].

Types of laser used in MALDI

Lasers are used Ultraviolet (UV) and infrared (IR), but ultraviolet is the most important light source adopted in the analysis of MALDI [15].

2.3.1.2. Electrospray Ionization (ESI)

Electrospray ionization Mass Spectrometry (ESI-MS) gives a solid, tough, and delicate device for concentrating on tiny biomolecule amounts in the size of femto-mole in miniature liter; it also allows for studying non-volatile and thermally labile biomolecules that cannot be analyzed by other conventional methods [13].

ESI strategy involves electrical energy in the change of particles from arrangement into gas status before they are broke-down utilizing mass spectrometric examination techniques. In this way, ionic species in arrangement can be determined by ESI-MS to have improved awareness. Nonpartisan mixtures can likewise be switched over completely to ionic structure in arrangement or in gas status by ionization or protonation and in this manner can be concentrated on utilizing ESI-MS [13].

The exchange of ionic species from arrangement into the gas stage by ESI comprises of three stages shown in Figure 2.3:

1. Dispersion of a charged-droplet spray.
2. Evaporation of the solvent.
3. Ejection of ions from the highly charged droplets.

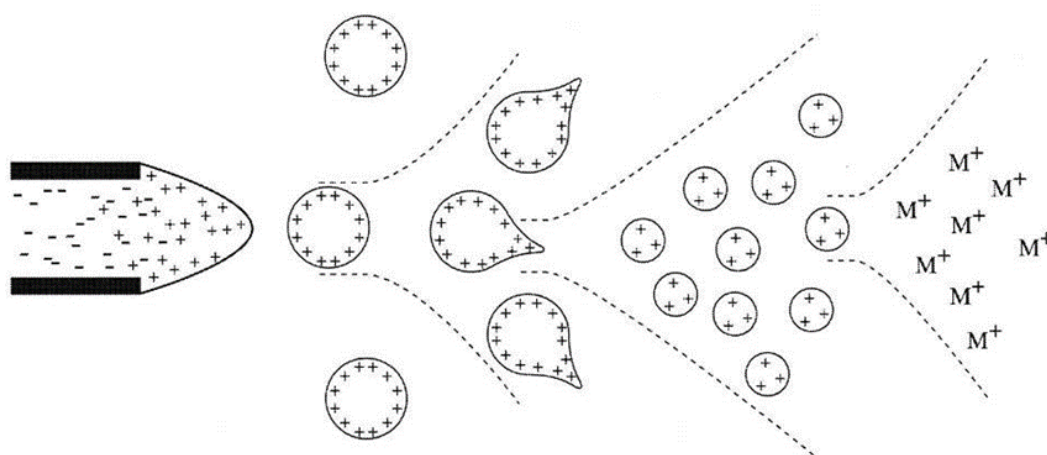

Figure 2.3. ESI steps [13].

The cylinder, which is kept up with at a high voltage (for example 3.0 - 6.0 kV) is appended to the mass of the chamber. An obscuring of high accreted drops of a similar extremity of the slim voltage is created. The execution of a nebulizing gas (like nitrogen) expands the example stream rate. The charged beads, created at the exit of the electrospray tip, pass down a possible inclination and a strain slope to the analyzer part of the mass spectrometer. With the assistance of a raised ESI-source temperature or one more stream of nitrogen drying gas, the charged drops are continually diminished in size by dissolvable vanishing, causing a lessening in the drop measurement and an expansion in surface charge thickness. At long last, the electric field power inside the charged drop arrives at a basic place where it is vigorously and dynamically feasible for particles on the outer layer of the arrangement drops to be catapulted into the gas states. The ions that have been discharged are sampled with a sampling skimmer cone and then propelled into a mass analyzer for molecular mass analysis and ion intensity measurement [13,17].

2.3.2. Mass Analyzers

The component of an instrument called a mass analyzer is where particles are isolated based on their m/z values. In a mass spectrometer, the detachment of particles is normally electrically determined, albeit conventional analyzers, in particular, attractive areas, utilize an attractive field that impacts particle partition. Like the ionization cycle as far as the accessible approaches, there are various frameworks that can segregate particles in view of their m/z values. Presently, four fundamental analyzers are generally utilized by mass spectroscopists, specifically, quadrupole (Q), quadrupole particle trap (QIT), season of flight (ToF), and Fourier change particle cyclotron reverberation (FT-ICR). These analyzers differ in size, cost, goal, mass reach, and the capacity to perform pair mass spectrometry tests. A mass analyzer is the piece of the machine what isolates particles because of their m/z values. In a mass spectrometer, particles are generally electrically disconnected. Albeit customary gadgets utilize an attractive field to direct the confinement cycle. Similar to the ionization process, some many systems and methods can isolate ions due to their m/z values [18]. Currently, four major standard analyzers are used in the mass spectrometric analysis:

1. Time of flight (ToF).
2. Quadrupole (Q).
3. Fourier transform ion cyclotron resonance (FT-ICR).
4. Quadrupole ion trap (QIT).

These analyzers are different in terms of mass range, resolution, price, size, and the capability to conduct tests using tandem mass spectrometry (MS/MS). Although quadrupole ion trap (QIT) is capable of performing multiple mass spectrometric tests (MSⁿ), FT-ICR is very powerful and accurate in mass measurements [18].

2.3.2.1. Quadrupole Analyzer

This analyzer comprises of four equal anodes, as displayed in Figure 2.4. Two of these cathodes receive an application of a (DC) current potential, and the other two terminals are connected to an exchanging radio-recurrence (RF) potential (the potential is named V , and the recurrence is called w). The particles made in the ionization chamber are beat to a quadrupole using a 5 kV electrical field. For instance, an emphatically charged particle will push toward the adversely charged terminal. Notwithstanding, when the extremity is changed, the particle will change its development course prior to raising a ruckus around town. In comparable circumstances, particles will go through complex swaying (direction). With the reasonable upsides of W , V , and U , just particles inside a little scope of m/z will get by toward the identifier. The other particles will go through "some unacceptable" direction and will at long last crash into one of the anodes. The sloping of W , V , and U qualities can cause the transmission of a few particles (with various m/z values) close to the identifier. This worked on portrayal of a quadrupole depends on the Mathieu condition, a convoluted second-request differential condition [18].

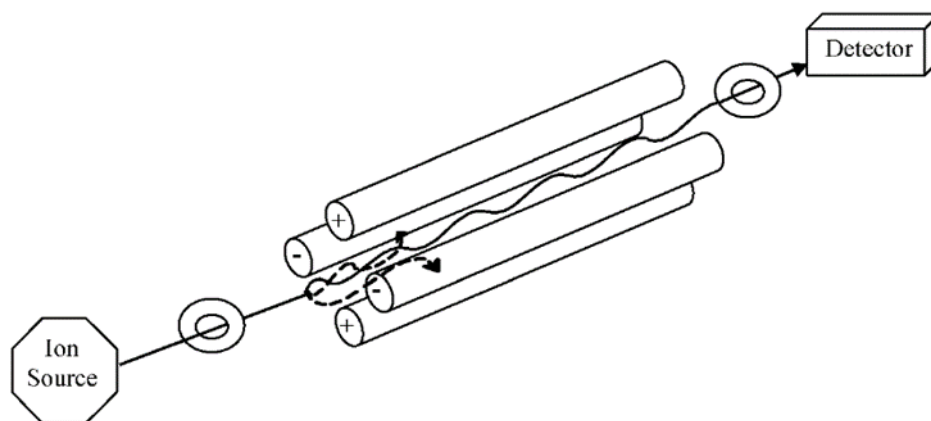

Figure 2.4. Quadrupole mass analyzer [18].

The principal benefits of quadrupole analyzers are their heartiness, simplicity of upkeep, little size, and minimal expense. A quadrupole has restricted capacities concerning mass reach (under 4000 Da), the capacity to perform MS/MS examination, and settling power. The detriment of restricted capacity to perform MS/MS investigation can be overwhelmed by connecting the quadrupole to a ToF (Q-ToF) or by joining the quadrupole to different analyzers, for example, extra quadrupoles (triple quadrupole instrument). A RF-just quadrupole (in cross breed mass spectrometers) will go about as a particle centering gadget that guides particles to different pieces of the instrument. This usefulness can be improved with octapoles and hexapole, which can't proceed as particle channels [18].

2.3.2.2. Time of Flight (TOF)

This particle partition convention is perhaps of the clearest technique, and in spite of the fact that it was first depicted in the twentieth hundred years, it was reintroduced in 1990s. ToF essentially tends to rely upon the free trip of the ionized particles inside a cylinder with the length between 1-2 m prior to arriving at the finder. As displayed in Figure 2.5, if two particles (A1 and A2) are framed at a similar second with a similar charge however the mass of A1 is not exactly the mass of A2, A1 will crash into the identifier before A2. The significant benefit of a ToF analyzer is that all framed particles will at last arrive at the locator (dissimilar to area instruments or

quadrupoles). The equation that combines m/z with a total time of flight (TF) is expressed in Equation 2.1:

$$\frac{m}{z} = \frac{t_f^2 2Es}{2s + x} \quad (2.1)$$

In Equation 2.1, x is the length of the free flight region, s is the length of the ion acceleration region, and E is the voltage applied. Theoretically, s , x , and E are fixed; thus, Equation 2.1 can be reduced to:

$$\frac{m}{z} = K t_f^2 \quad (2.2)$$

Here K is the adjusting factor. This condition addresses the immediate connection between the m/z esteem and the ToF. Despite the fact that ToF enjoys the benefit of being able to identify an exceptionally wide mass reach, the cylinder linearity of a customary ToF analyzer (Figure 2.5a) can influence its settling power, since particles entering the ToF have different dynamic energies (KE), this will clearly influence the goal and sub-atomic particle estimations. This burden was overwhelmed by fostering the reflectron (electrostatic particle reflect), which is a particle optic gear that changes particles way inside the ToF, as displayed in Figure 2.5b. Particles with higher motor energy (KE) will infiltrate further into the particle reflect, and accordingly particles will be step by step repulsed, working on the goal of the ToF estimations. One more component is the cylinder length; since particles (in reflectron-ToF) are voyaging a more extended way, precise mass estimations and improved goal can be gotten due to the expanded flight time. "Reflection-type" mass analyzers ordinarily have two locators: the first is behind the particle reflect, and the subsequent one is put toward the finish of the particle way. Because of the way that a particle misfortune can be brought about by reflectron, the administrator can choose whether to think twice about or goal. On account of the idea of ToF, it is broadly connected to the MALDI particle source. By and by, ToF can likewise be associated with an ESI source in mixture instruments or symmetrical ToF, fit for performing pair mass spectrometric tests. These ionization sources, in reconciliation with mass analyzers like the hour of flight

(ToF) permit the recognition of macromolecules which work out positively past the uber Dalton mass reach [3].

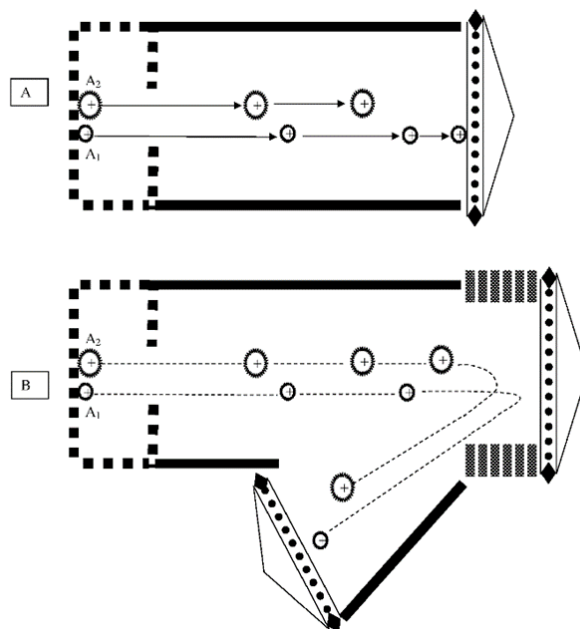

Figure 2.5. ToF mass analyzer a) conventional ToF, b) reflectron-type ToF [18].

2.3.2.3. Orbitrap

This kind of mass analyzer comprises of three terminals, as displayed in Figure 2.6. The patterns address both the high-field smaller snare and the standard snare. The external cathodes are cup-molded, confronting one another, and are electrically segregated by an exceptionally slender hole encompassed by a ring made of a protector material. A focal shaft-molded terminal keeps the snare parts together and adjusts them through protecting end spacers. At the point when voltage is supplied between the major terminal and the external terminal, the subsequent electrical field is precisely straight on the hub, thus motions toward this path will be absolutely symphonious. Simultaneously, the spiral part of the field powerfully draws in particles to the focal terminal [19].



Figure 2.6. Orbitrap analyzer [19].

Particles are infused into the region between the external and focal terminals, basically on an unexpected digression over an exceptionally machined space by a pay cathode (redirector) in one among the outside cathodes. With voltage applied between the external and focal terminals, an outspread electrical field twists the particle way to the focal cathode, though the distracting speed makes an inverse radial power. With a legitimate selection of boundaries, the particles stay in a round winding inside the snare, like the development of the planets in the planetary group. Simultaneously, the hub electrical field created by the conelike state of the cathodes pushes the particles towards the more extensive piece of the snare, causing consonant pivotal motions. Then, at that point, the outer cathodes are utilized as beneficiaries to get these pivotal motions, and afterward these motions are changed over into the recurrence space utilizing the Fourier change similarly as in FTICR, and afterward they are changed over into a mass range [19].

2.4. MASS SPECTROMETRY BASED GLYCOSYLATION ANALYSIS

Protein glycosylation investigation has been a difficult errand for scientific natural chemists for quite a while. Contrasted with different kinds of biomolecules, particularly lipids and peptides, the essential construction of glycans, either alone or joined with a protein, won't be quickly settled utilizing a solitary method. Fanning, linkage, variable piece, and anomericity of the constituent monosaccharaides joined with the overall heterogeneity due to the aberrant, non-format control of their biosynthesis are the premise of the primary intricacy of glycoprotein glycans. As a result, many methods are often necessary to determine a glycan's structure. One of the most common techniques is mass spectrometry (MS) [20].

2.4.1. Enrichment of Glycopeptides

Numerous biological processes depend on protein glycosylation. It has a role in cellular secretion and cellular targeting. It is also engaged in organizing enzymatic activities, enhancing solubility and stability of secreted proteins, and it affects protein functions in the immune system. Furthermore, glycoproteins engage in cell-matrix and cell-cell interactions. Glycosylation process is one of the most prevalent post-translational protein modifications [21].

For the most part, glycosylation investigation must be performed on different levels: glycopeptides, flawless glycoproteins, as well as delivered glycans. Flawless glycoproteins Examination envisions the in general glycoforms of a protein populace. It is frequently used on refined proteins with a predetermined number of glycosylation sites or a fixed number of various glycans. Data on the protein's glycan heterogeneity are obtained from research on the supplied glycans. It can, along with the realized protein grouping, be extremely useful in deciphering glycopeptide/protein MS information. Notwithstanding, neither of these two sorts of examinations gives data on the real area of glycosylation. To relegate glycosylation areas, the protein must be proteolytically separated into peptides. MALDI mass spectrometry can break down clear cut peptides with one glycosylation site, where the site and joined glycan moieties can frequently be unambiguously relegated. Utilizing LC-ESI-MS, peptides with

numerous areas can be isolated chromatographically and broke down upon elution. Notwithstanding, peptides with different locales stay an aggressive test. The amount of sample that can be used will frequently have an impact on how much information can be learned about the glycosylation of a given protein [21].

2.4.2. MALDI-MS Analysis of Glycopeptides

In the past few years, matrix-assisted laser desorption/ionization (MALDI-MS) has become one of the typical soft ionization methods that is widely used for analyzing a wide range of biomolecules, including glycopeptides. MALDI has usually combined with time-of-flight (TOF) mass analyzers and is particularly quick and easy to use [22].

Atoms normally have electronic, vibrational, rotational, and active energy in the condition of fluids and gases. Assume a solitary particle or gathering of particles in a strong state has expanded in their interior energy (e.g., by radiation or intensity) over a nearly significant stretch of time (scarcely any microseconds). All things considered, the atoms can equilibrate their energy together and separately so the overabundance energy is dispersed to the encompassing medium without changing the sub-atomic construction. Nonetheless, by investing a lot of time into an example in a concise period, (for example, a laser beat), the energy can't be conveyed to its general climate quickly enough, and the example is essentially discarded from the objective region in light of an enormous addition in motor energy. This strategy can cause vaporization, liquefying, conceivable obliteration of material and ionization of analytes (significant for MS). This is the basic of laser desorption/ionization (LDI), which has been utilized for over 50 years in the examination of natural and inorganic colors, salts, and so on. In any case, restricted to masses are under 1000 u, as the energy move is difficult to control and frequently prompts extreme warm corruption. The significant development toward higher masses was achieved by embedding the analyte molecules in low concentration inside a liquid or solid matrix with high light-absorbance. This way, a controllable and efficient energy transfer was realized by protecting the molecules from extra energy. This technique is known now as MALDI and has significantly changed the methodologies and methods of studying synthetic and large biological polymers [23].

2.4.3. ESI-MS/MS Analysis of Glycopeptides

Like other mass spectrometers, ESI-MS/MS additionally comprises of three fundamental parts, the mass analyzer, particle source, and finder, as displayed in Figure 2.7. The unblemished atomic particles are generated in the ionization chamber where the particle emission source is put. After that, they are transported into the mass analyzer area through multiple ion optics (electromagnetic objects like focusing lenses, multipoles, skimmers, etc.), which are essentially kept to focus the ion flow to maintain a stable route of the ions. The ions are separated and organized by the mass analyzer (m/z) in accordance with their mass-to-charge ratio [24].

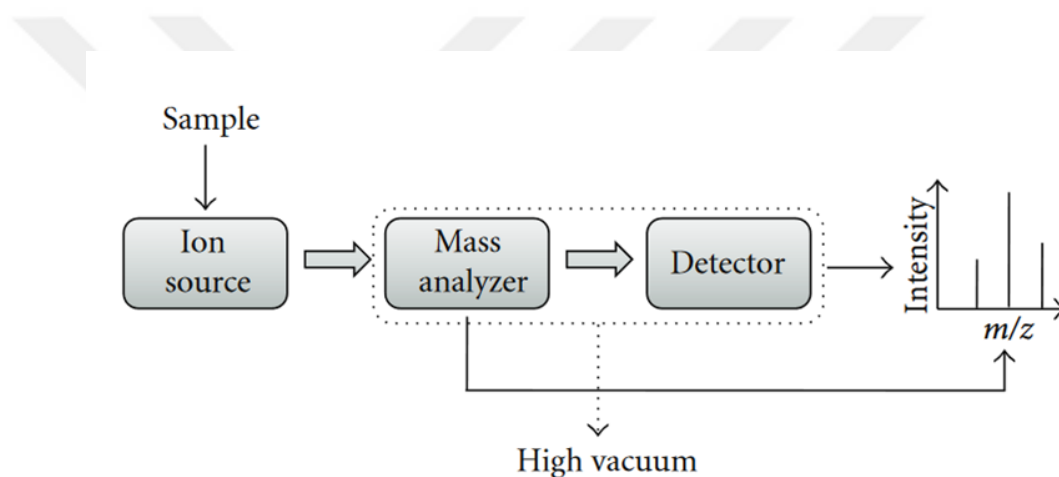

Figure 2.7. The basic components of the ESI-mass spectrometer [24].

From that point forward, the arranged and isolated particles are moved to the identifier to quantify their focus, and the outcomes are displayed as a chart called a mass range, as displayed in Figure 2.8. Since the particles in the gas state are exceptionally receptive and frequently have short lives, they ought to be shaped and controlled in a high vacuum. Hence, the spectrometer parts (analyzer, particle optics, and the identifiers) are safeguarded at an exceptionally high vacuum (ordinarily from 10^{-3} torr to 10^{-6} torr pressure). MS instruments as a rule use either turbomolecular siphons or oil dissemination siphons to get the high vacuum expected to work the MS instrument. As a general rule, the particle source is safeguarded at climatic tension, and a voltage inclination and a persistent strain slope are utilized from the source to

the identifier to assist with siphoning out the particles from the source to the finder through the analyzer [24].

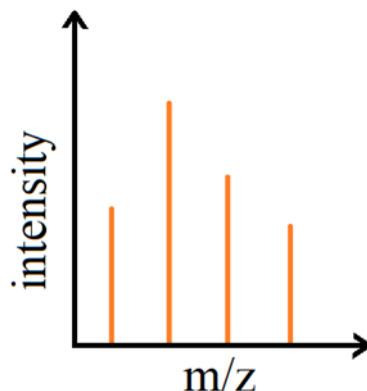

Figure 2.8. Mass spectrum.

2.5. STAGE-TIP APPLICATIONS FOR GLYCOPROTEOMICS

Glycoproteomics is recently experiencing extensive development in terms of methodologies and the range of applications simplified by these approaches and improvements in instrumentation. The comprehensive comparative glycoproteomic analyzes have gained a lot of attention due to two main reasons [25]:

1- Practically, the oligosaccharide moieties of various glycoproteins go about as selectivity determinants, assuming an essential part in a few natural cycles, for example, cell guideline and resistant reaction since cell-to-cell cooperations incorporate sugar-protein-or sugar-explicit acknowledgment. Considering and breaking down glycoproteins can give significant data with respect to their jobs in a particular organic framework and will reveal insight into the pathogenesis and system of specific illnesses [25].

2- The ongoing snag to finding biomarkers in bio-liquids, for example, serum utilizing mass spectrometry is the restricted unique scope of location contrasted with a lot more extensive scope of protein focuses in the examples. Focusing on a subset of the entire proteome, for example, glycoproteome, can be an effective answer for improve on the

example and lower as far as possible. Besides, the abnormal glycosylation examples could give proof to infection important biomarkers [25,26].

2.5.1. Cancer

The glycosylation profiles change clearly during oncogenesis. For instance, an extended movement of N-acetylglucosaminyltransferase V, which is a chemical answerable for the production of fanning N-connected glycans, has been connected to growth metastasis and attack in different tumors. Hence, growth emitted glycoproteins can go about as likely focuses for finding biomarkers for diagnostics. Public service announcement is one of the most outstanding characterized growth biomarkers, a discharged glycoprotein with one characterized N-connected glycan chain. Public service announcement is basically discharged by prostatic epithelial cells into the fundamental plasma. The glycoforms of public service announcement in prostate disease patients have been demonstrated to be not quite the same as those of solid controls. Moreover, growth related changes in glycan designs can be expected focuses for disease immunotherapy, like epitopes for restorative monoclonal antibodies [25,27–31].

2.5.2. Neurodegenerative Diseases and Neurobiology

Glycoproteomics approaches have found typical applications in neurodegenerative disease research, with the goal of diagnosing the diseases and studying their mechanisms. It is known that abnormal changes in glycosylation occur in Alzheimer's disease (AD). Recent research works have shown that aberrant glycosylation might modify tau protein at a substrate level, so which makes it easier to be phosphorylated and harder to be dephosphorylated at several phosphorylation sites in the Alzheimer's disease brain. Coworkers and minor identified glycosylated isoforms of butyrylcholinesterase and acetylcholinesterase that are growing in Alzheimer's cerebrospinal fluid (CSF). Furthermore, glycosylation patterns have been found to be changed in other neurodegenerative disorders. For instance, Reelin, which is a glycoprotein that is essential for the right cytoarchitectonic game plan of the creating focal sensory system (CNS), is up-controlled in the mind and CSF in different

neurodegenerative illnesses, including Parkinson's sickness, front worldly dementia, moderate supranuclear paralysis (PD), and Alzheimer's. In addition, Reelin's glycosylation designs contrast in CSF and plasma, and the CSFs of unhealthy and control tests likewise show different glycosylation designs. These outcomes demonstrate that glycoprotein Reelin is engaged with the pathogenesis of numerous neurodegenerative problems [25,32].

2.5.3. Other Applications

In light of the wealth of glycosylation and its far-reaching contribution in a few physiological cycles, glycoproteomics has a few applications in different fields, like plant science, microbial science, and diabetes. Be that as it may, a large portion of those reviews zeroed in on glycan structure assurance or glycoprotein ID, while a couple of followed a quantitative methodology [25,33,34].

PART 3

MATERIALS AND METHODS

3.1. MATERIALS

The chemical substances and proteins used in this work, including the human plasma and human IgG, were obtained from Sigma Aldrich (Milwaukee, WI, USA). The cotton wool was purchased from a local market, and the PNGase F enzyme was purchased from Promega.

3.2. PROTEOLYTIC DIGESTION OF IGG AND HUMAN PLASMA GLYCOPROTEINS

IgG was used in the study as a standard glycoprotein. First, 3 mg of IgG were dissolved with 200 μ L of 25 mM ABC and vortexed carefully. Di-sulfide bonds of IgG was reduced by adding 8.3 μ L of 0.25 M DTT, and the samples were incubated at 56 °C for 40 min. Then, 18.1 μ L of 0.25 M IAA was added to samples for alkylation. The samples were kept dark at room temperature for 30 min. Finally, a trypsin enzyme was added to samples by w/w, protein/enzyme, and 30/1 ratio. Overnight, the samples were incubated at 37 °C. Human plasma (3 mg) was also digested with the same protocol described above.

3.3. PREPARATION OF THE COTTON CONTAINING STAGE-TIP

A pipette tip with the capacity of 200 μ L was used for the preparation of HILIC enrichment stage tips. About 3 mm of cotton wool was inserted into the bottom of the pipette tips with the help of a needle, as shown in Figure 3.1. The sepharose CL-4B and cellulose were inserted with a certain amount into these stage tips for the enrichment of glycopeptides.



Figure 3.1. A microcentrifuge tube with a HILIC stage tip.

They are called stage-tips mostly because it is used throughout the experiment. As each group or individual of stage-tips represents a particular stage during the experiment workflow.

3.4. ENRICHMENT OF GLYCOPEPTIDES USING HILIC-SORBENT CONTAINING STAGE-TIPS

The stage-tips, cotton, cotton + cellulose, cotton + sepharose CL-4B, and cotton + cellulose + sepharose samples were prepared. After that, several steps were applied for the enrichment of *N*-glycopeptides. All experiments were performed in triplicates.

For preparing cotton + cellulose stage tips, a solution of microcrystalline cellulose (50 mg mL⁻¹) was prepared in deionized water. Then, 50 µL of cellulose was added to the cotton-containing stage tips. For cotton + sepharose CL-4B containing stage tips, 50 µL sepharose CL-4b was inserted from commercially available material. Finally, 50 µL of sepharose CL-4b and 50 µL of microcrystalline cellulose were inserted into the cotton-containing stage tip for the cotton + cellulose + sepharose CL-4B containing stage tip. The following protocol was applied for all HILIC sorbent-containing stage tips to enrich glycopeptides.

The experiment described below was achieved by centrifugal separations. The stage tips were washed using 0.2 mL of deionized water at 2000 rpm for 2 min. The stage tips were rewashed with 0.2 mL of ACN/MQ/TFA, 85/15/1, and v/v for conditioning at 2x 2000 rpm for 2 min. 100 μ L of loading solution (ACN/ H₂O /TFA 85/15/1), including 5 μ g peptide products, were loaded two times by centrifuge at 2000 rpm for 2 min. Then, the stage tips were washed two times with 200 μ L of loading buffer and 200 μ L of washing buffer (ACN/H₂O, 85/15) at 2000 rpm for 2 min. The elution was achieved using 50 μ L of 100% c. The samples were then analyzed by MALDI-MS.

300 μ g of human plasma digest was dissolved with loading buffer to enrich human plasma samples. The same protocol was applied for the enrichment of glycopeptides. The washing steps were applied three times at 2000 rpm for 2 min. Elution was achieved at 100 μ L of 100% H₂O. The eluted glycopeptides were analyzed by nLC-QExactive Plus mass spectrometry.

3.5. MALDI-MS ANALYSIS

MALDI-MS analysis of the enriched glycopeptides was achieved by Rapiflex MALDI-TOF/TOF-MS instrument (Bruker Daltonics, Bremen). The ionization was achieved in positive ionization mode. A matrix solution was prepared with 5 mg of DHM matrix dissolved in ACN/H₂O by volume of 1/1. The dried droplet technique was used for spotting. One μ L of samples was dropped to the MALDI target plate and allowed to dry. Then, one μ L of DHB matrix was added to it. The spectra were recorded with 5 kV at 1000-5000 Da mass range. The obtained data were evaluated with FlexAnalysis software. S/N ratio, which is higher than six, was taken care of for the detection of *N*-glycopeptides and ordinary peptides for the data evaluation.

The reason of choosing MALDI-MS Analysis over another analysis methods is because MALDI-TOF MS has a few benefits compared to ESI-MS.

First, MALDI-TOF Compared to ESI-MS, MS generates singly charged ions, making data interpretation simple.

Second, In contrast to MALDI-TOF MS analysis, ESI-MS analysis necessitates previous chromatographic separation. Consequently, MALDI-TOF mass spectrometer has emerged as the clear choice for large-scale proteomics work due to the complete automation's high throughput and speed.

3.6. NLC-MS/MS ANALYSIS

The human plasma samples after the enrichment of HILIC sorbent containing stage tips were analyzed by nLC-QExactive Plus mass spectrometry equipped with 3000 RSLC nanoflow chromatography. In the chromatographic separations, mobile phase A was 100% H₂O including 0.1% FA, and mobile phase B was 80% ACN including 0.1% FA. The peptide separation was achieved by increasing the volume of mobile phase B by 5% from 40% for 90 min. The “top 5” methods were used in the mass spectrometric analysis. Stepped HCD (20, 30 and 40) was used for the site-specific identification of *N*-glycopeptides. The mass spectra were recorded within the mass range of 500-2200, *m/z*.

The obtained raw data were imported to the MSfragger software. This software allows site-specific *N*-glycosylation analysis of glycoproteins. N-glycoHCD method was used as its default features. The human proteome was downloaded from UNIPROT database and their sequence was recognized to software. The MS tolerance was 20 ppm. The software was first extracted *N*-glycopeptide signals searching oxonium ions in all detected MS/MS spectra. Then, the glycan and peptide sequences of glycopeptides were determined. The detected peptides having glycosylation modification was listed and counted for comparison of the used HILIC materials to define their enrichment performance in case of use human plasma samples.

PART 4

RESULTS AND DISCUSSION

In the thesis, a new glycopeptide enrichment platform was established for site-specific glycosylation analysis of N-glycopeptides. This platform includes a stage-tip application process using HILIC-based sorbents. The HILIC-based sorbents were used together with cotton-HILIC in the stage tip. Figure 4.1 shows the application of stage-tip in the study. Three different HILIC sorbents were used in this application. These are cotton, cellulose, and sepharose CL-4B, which can be obtained commercially. They are used as follows: cotton, cotton+cellulose, cotton+spharose CL-4B, and cotton+cellulose+spharose CL-4B in the stage tips. These prepared stage tips, including HILIC sorbents, were used for testing N-glycopeptide enrichment performance. In addition, several parameters, including elution and loading conditions, were tested.

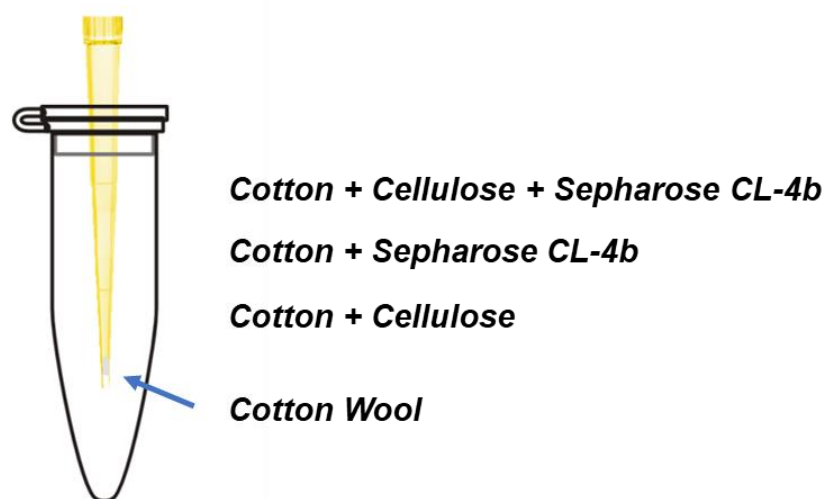

Figure 4.1. An illustration of used stage-tips used in the study.

4.1. COMPARISON OF DIFFERENT ELUTION CONDITIONS FOR THE ENRICHMENT OF IGG *N*-GLYCOPEPTIDES

We used IgG digests in the study to compare elution parameters for all HILIC-sorbent-containing stage tips. The protocol for loading conditions was the same for all applications described in the method section. The elution solvents tested in the study are given in Table 4.1. The experiments were done for each stage-tips. An example MALDI-MS spectrum regio belonging to IgG *N*-glycopeptides is shown in Figure 4.2. The glycopeptides for IgG were determined in the m/z of 2200-3300 in MALDI-MS spectra. When the obtained spectrum was investigated, a maximum of 35 *N*-glycopeptides were detected for IgG in the MALDI-MS analysis. These glycopeptides matched the previously published articles [35] and were listed in Table 4.2.

Table 4.1. The elution solvents used in the study.

Number	Elution Solvent
1	100% H ₂ O
2	90% H ₂ O 10% ACN
3	80% H ₂ O 20% ACN

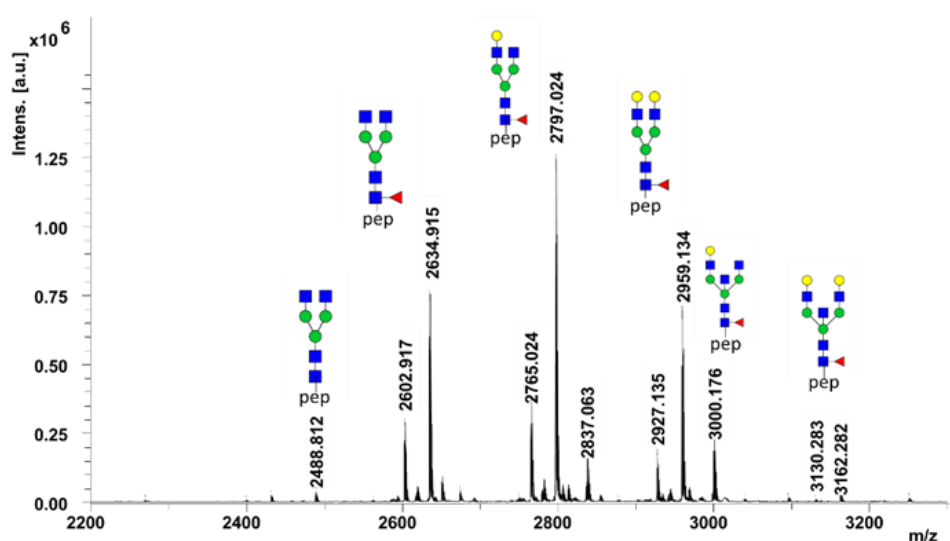

Figure 4.2. MALDI-MS spectrum of IgG *N*-glycopeptides.

Table 4.2. A list of the *N*-glycopeptides of IgG.

No	Peptide Sequence	Glycan Structure	<i>N</i> -glycopeptides Theoretical Mass (m/z)
1	EEQFN*STFR (IgG2)	Hex2HexNAc3Fuc1	2236.924
2	EEQYN*STYR (IgG1)	Hex2HexNAc3Fuc1	2268.914
3	EEQFN*STFR (IgG2)	Hex3HexNAc3Fuc1	2398.977
4	EEQYN*STYR (IgG1)	Hex3HexNAc3Fuc1	2430.966
5	EEQFN*STFR (IgG2)	Hex3HexNAc4	2455.998
6	EEQYN*STYR (IgG1)	Hex3HexNAc4	2487.988
7	EEQFN*STFR (IgG2)	Hex4HexNAc3Fuc1	2561.03
8	EEQYN*STYR (IgG1)	Hex4HexNAc3Fuc1	2593.019
9	EEQFN*STFR (IgG2)	Hex3HexNAc4Fuc1	2602.056
10	EEQFN*STFR (IgG2)	Hex4HexNAc4	2618.051
11	EEQYN*STYR (IgG1)	Hex3HexNAc4Fuc1	2634.046
12	EEQYN*STYR (IgG1)	Hex4HexNAc4	2650.041
13	EEQFN*STYR (IgG4)	Hex3HexNAc5	2675.072
14	EEQYN*STYR (IgG1)	Hex3HexNAc5	2691.067
15	EEQFN*STFR (IgG2)	Hex4HexNAc4Fuc1	2764.109
16	EEQFN*STFR (IgG2)	Hex5HexNAc4	2780.104
17	EEQYN*STYR (IgG1)	Hex4HexNAc4Fuc1	2796.099
18	EEQFN*STFR (IgG2)	Hex3HexNAc5Fuc1	2805.135
19	EEQYN*STYR (IgG1)	Hex5HexNAc4	2812.094
20	EEQFN*STFR (IgG2)	Hex4HexNAc5	2821.13
21	EEQYN*STYR (IgG1)	Hex3HexNAc5Fuc1	2837.125
22	EEQYN*STYR (IgG1)	Hex4HexNAc5	2853.12
23	EEQFN*STFR (IgG2)	Hex4HexNAc4NeuAc1	2909.146
24	EEQFN*STFR (IgG2)	Hex5HexNAc4Fuc1	2926.162
25	EEQFN*STYR (IgG4)	Hex5HexNAc4Fuc1	2942.157
26	EEQYN*STYR (IgG1)	Hex5HexNAc4Fuc1	2958.152
27	EEQFN*STFR (IgG2)	Hex4HexNAc5Fuc1	2967.188
28	EEQFN*STFR (IgG2)	Hex5HexNAc5	2983.183
29	EEQYN*STYR (IgG1)	Hex4HexNAc5Fuc1	2999.178
30	EEQYN*STYR (IgG1)	Hex5HexNAc5	3015.173
31	EEQFN*STFR (IgG2)	Hex4HexNAc4Fuc1NeuAc1	3055.204
32	EEQFN*STFR (IgG2)	Hex5HexNAc5Fuc1	3129.241
33	EEQYN*STYR (IgG1)	Hex5HexNAc5Fuc1	3161.231
34	EEQFN*STFR (IgG2)	Hex5HexNAc4Fuc1NeuAc1	3217.257
35	EEQYN*STYR (IgG1)	Hex5HexNAc4Fuc1NeuAc1	3249.247

The IgG *N*-glycopeptides listed in Table 4.2 were taken care of to compare elution conditions. MALDI-MS analysis of IgG *N*-glycopeptides was obtained after enrichment with cotton-HILIC stage-tip using three elution conditions. The obtained

data were compared for the identification rate of IgG *N*-glycopeptides. Figure 4.3 shows the comparison of the detected *N*-glycopeptides for all HILIC-sorbents.

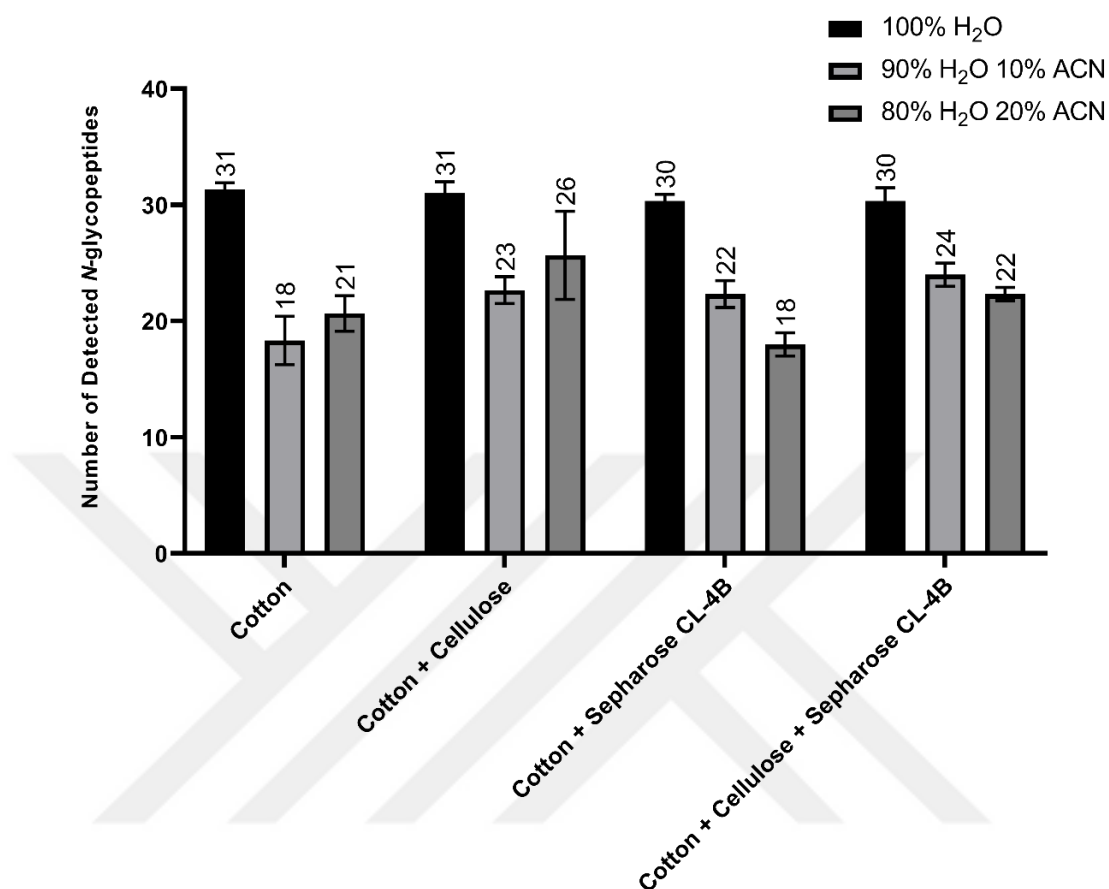

Figure 4.3. The detected IgG *N*-glycopeptides after enrichment using different HILIC sorbents containing stage tips from three elution conditions.

The obtained data were checked for the identification rate of IgG *N*-glycopeptides. The *m/z* values of *N*-glycopeptides were extracted from FlexAnalysis software, and the number of detected glycopeptides was determined. The number of the detected IgG *N*-glycopeptides was the highest for the elution of the glycopeptides by 100% of H₂O. It was determined that there were no significant differences between HILIC-sorbents for the identification rate of IgG *N*-glycopeptides. The best choice for the elution condition of HILIC-sorbents was found to be 100% H₂O, which is also the most suitable solution for the mass spectrometric analysis of the samples.

4.2. COMPARISON OF DIFFERENT LOADING CONDITIONS FOR THE ENRICHMENT OF IGG *N*-GLYCOPEPTIDES

The loading conditions were tested in the study to compare the loading conditions on the identification rate of *N*-glycopeptides. Five different loading conditions were tested, which are listed in Table 4.3. We first compared the detected rate of IgG *N*-glycopeptides when it was applied to different loading conditions. The maximum identification rate for the IgG *N*-glycopeptides was found as the loading solvent of 85%ACN 1%TFA (Figure 4.4). In addition, there were no significant differences between HILIC-sorbents-containing stage tips for the identification rates of IgG *N*-glycopeptides. This situation was the same for all loading conditions.

Table 4.3. The loading solvents used in the study.

Number	Loading Solvent
1	85%ACN
2	85%ACN 1%TFA
3	85%ACN 2%TFA
4	85%ACN 3%TFA
5	85%ACN 4%TFA
6	85%ACN 5%TFA

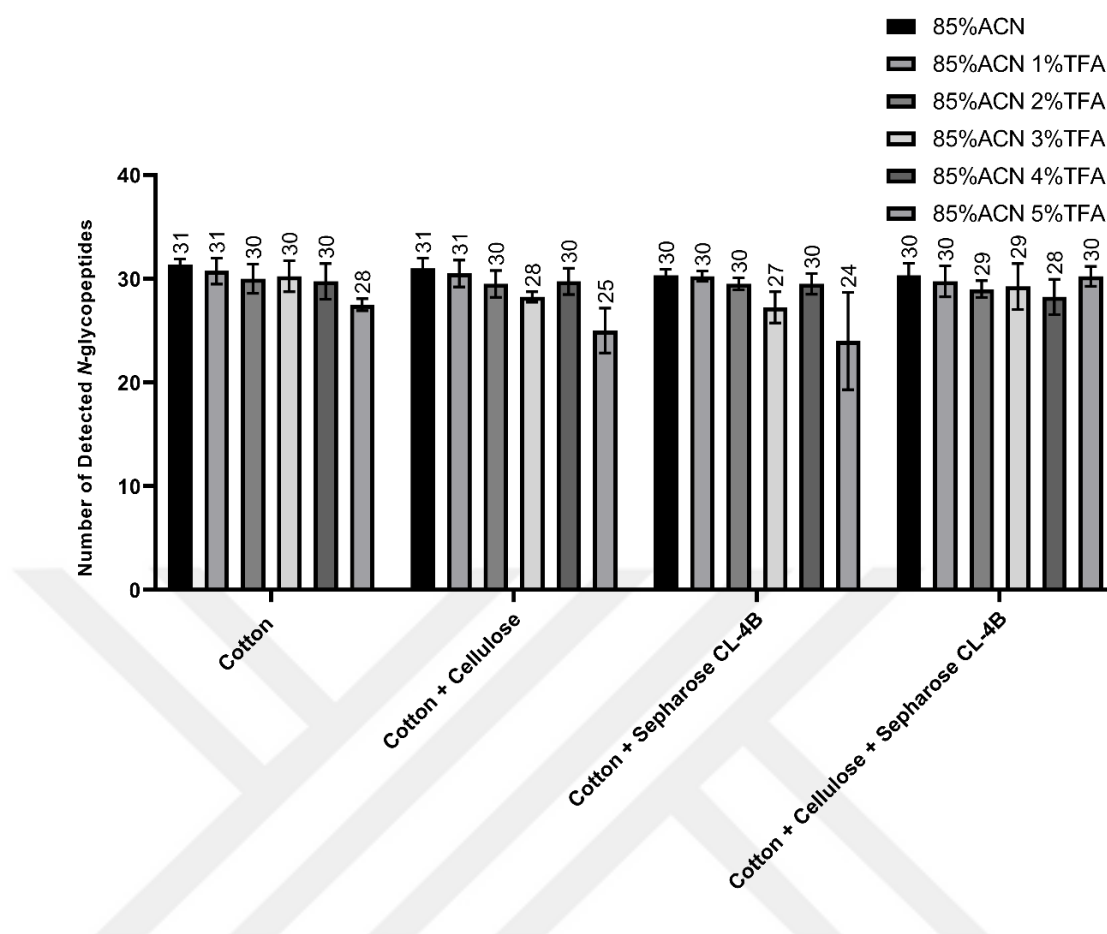

Figure 4.4. The number of detected IgG *N*-glycopeptides after enrichment using different HILIC sorbents containing stage tips from six loading conditions.

4.3. COMPARISON OF SELECTIVITY OF HILIC-SORBENTS CONTAINING STAGE TIPS IN DIFFERENT LOADING CONDITIONS FOR THE ENRICHMENT OF IGG N-GLYCOPEPTIDES

The obtained data were evaluated for the selectivity of HILIC-sorbent containing stage-tips in different loading conditions. Figure 4.5 shows the number of detected ordinary peptides for the HILIC-sorbents in loading conditions applied in the study to enrich IgG *N*-glycopeptides. The number of detected regular peptides was high for the loading condition of 85% ACN for all HILIC-sorbents. The detected ordinary peptides were increased when HILIC-sorbents cellulose and sepharose CL-4B were used together with cotton wool. On the other hand, when TFA was added to loading solvents, the detected ordinary peptides were decreased. This situation was also observed for all HILIC-sorbent containing stage tips.

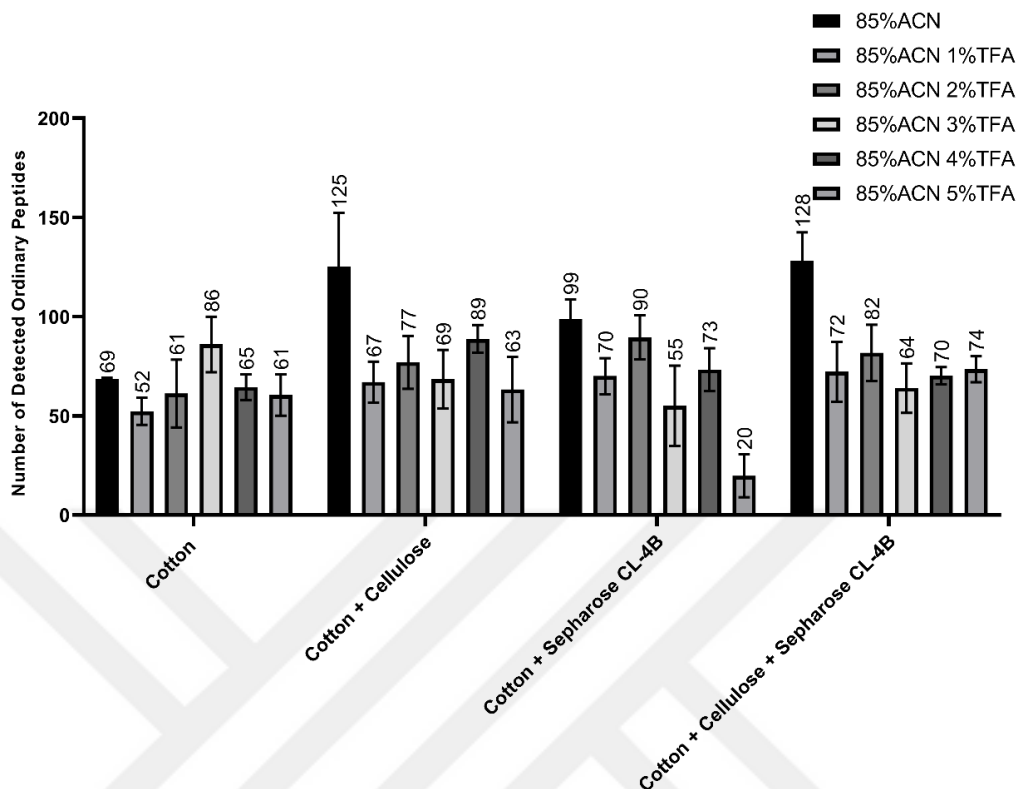

Figure 4.5. The number of detected ordinary peptides in different loading conditions for HILIC-sorbents containing stage-tips.

It was determined that the maximum number of glycopeptides and the minimum number of the detected ordinary peptides were found for the loading condition of 85% ACN, including 1% TFA.

4.4. DETERMINATION OF THE SENSITIVITY OF DIFFERENT HILIC-SORBENT CONTAINING STAGE-TIPS

The used HILIC-sorbent containing stage tips was evaluated to determine the sensitivity of the applied method. In the experiments, the loading condition was 85% ACN, including 1% TFA and the elution condition was 100% H₂O. The experiments were performed using different amounts of IgG proteolytic products. Figure 4.6 displays the number of detected IgG *N*-glycopeptides used in various quantities of IgG digests for enrichment.

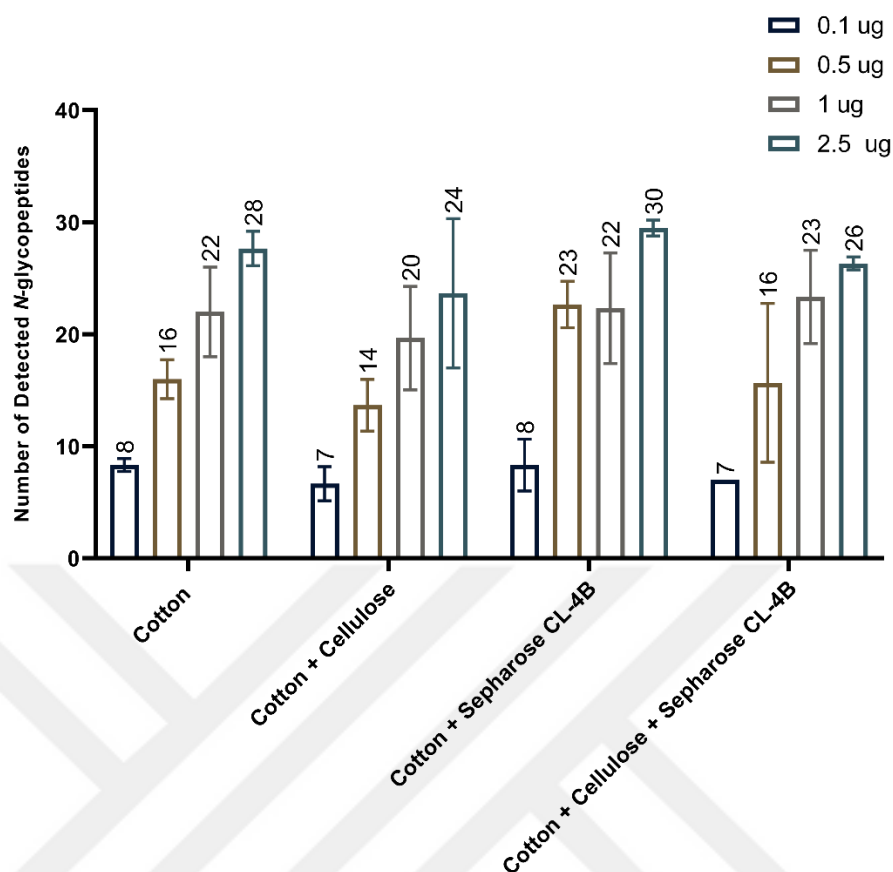

Figure 4.6. The number of detected IgG *N*-glycopeptides used in various amounts of IgG digests.

As expected, the number of the detected *N*-glycopeptides increased when a higher amount of IgG digest was used for the enrichment. This situation was the same for all HILIC sorbents. When the obtained data were investigated, the number of the detected *N*-glycopeptides was found to be maximum for cotton + sepharose CL-4B HILIC sorbents containing stage-tips. It was determined that no significant performance differences were seen for the enrichment of IgG *N*-glycopeptides from 0.1 μg IgG digests among HILIC-sorbent-containing stage tips. However, when 0.5 μg IgG digest was used for the enrichment, the best performance was achieved from cotton + sepharose CL-4B HILIC sorbent. In addition, the maximum number of the detected *N*-glycopeptides was detected from 2.5 μg of IgG digest when cotton + sepharose CL-4B HILIC sorbent was used for the enrichment.

4.5. EVALUATION OF THE PERFORMANCE OF HILIC SORBENT CONTAINING STAGE TIPS USED FOR THE ENRICHMENT OF GLYCOPEPTIDES FROM REAL-WORLD SAMPLES

The HILIC-sorbent containing stage tips was investigated when human plasma was used as a real-world complicated sample to enrich *N*-glycopeptides. The obtained data by the analysis of samples using nLC-QExactive-Plus were imported to MSFragger software for the recognition of *N*-glycopeptides. Site-specific N-glycosylation analysis of human plasma glycoproteins was performed by this approach, which is very significant for the detection of new biomarkers.

Figure 4.7 displays the number of detected *N*-glycopeptides and ordinary peptides by analyzing the samples after enrichment with different HILIC-sorbent-containing stage tips. The identification rate was first compared for HILIC sorbents. 274 *N*-glycopeptides were detected with cotton + cellulose, which is the highest detection rate among HILIC-sorbents. However, the ordinary peptides were 308 for cotton + cellulose. When all HILIC-sorbents were used together to enrich *N*-glycopeptides, the number of the detected ordinary peptides increased. 184 *N*-glycopeptides were detected from cotton + sepharose CL-4B sorbents. The maximum identification rate belonged to the cotton + cellulose stage-tip.

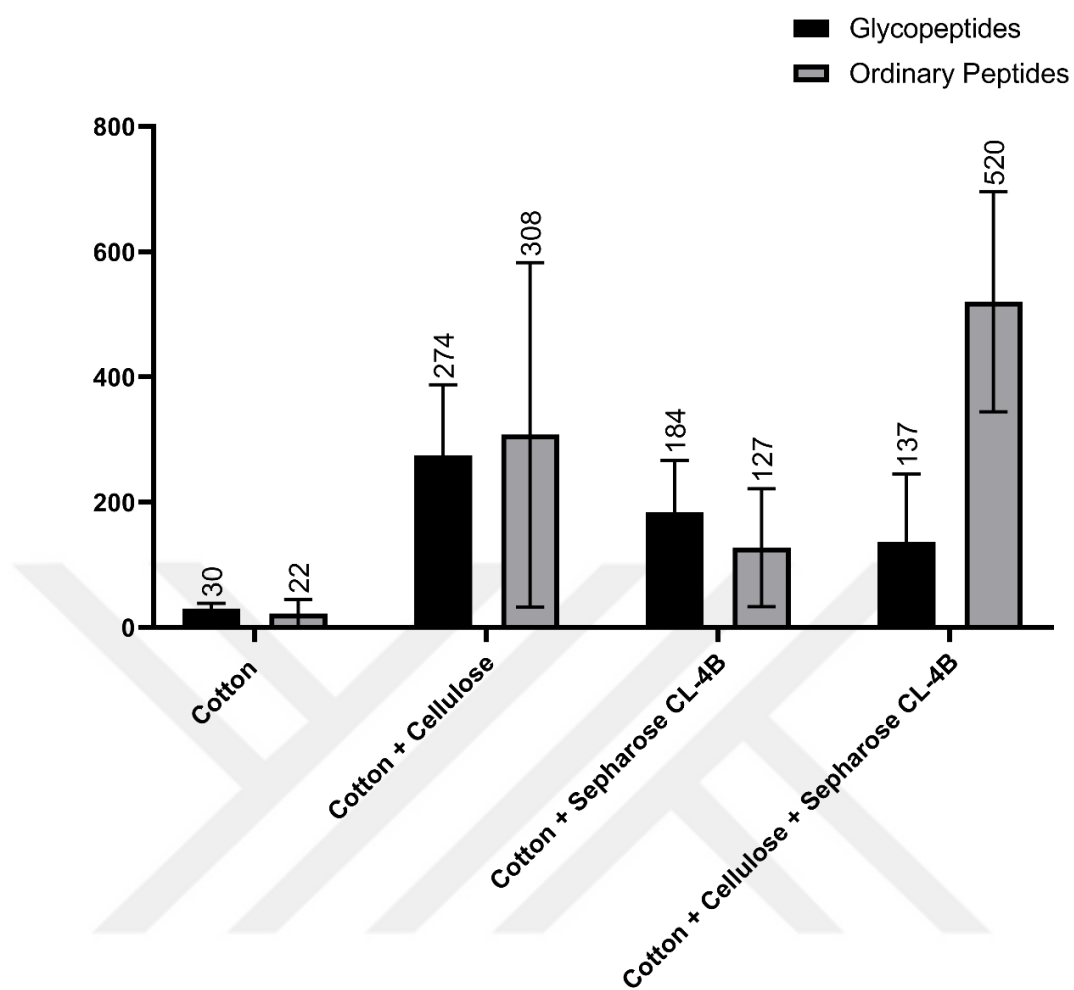

Figure 4.7. The number of detected human plasma *N*-glycopeptides and ordinary peptides when different HILIC-sorbent-based stage-tips were used for the enrichment.

PART 5

CONCLUSION

In the study, HILIC-sorbent containing stage-tips was used to enrich N-glycopeptides. Four different HILIC-sorbent-containing stage tips were developed and used in the study. Various loading and elution conditions were investigated for determining optimum enrichment conditions of HILIC-sorbent containing stage-tips. The identification rate reached the highest when 100% H₂O was used as an elution solvent. The selectivity of the HILIC-sorbents onto the N-glycopeptides was increased when TFA was added to the loading solvent, and 85% ACN, including 1% TFA was found to be the optimum loading solvent for HILIC-based enrichment. The enrichment of human plasma glycopeptide compared the HILIC-based sorbents with stage-tip application as a real-world complex sample. Cotton + cellulose was found to be the best choice regarding identification rates of *N*-glycopeptides. On the other hand, the number of the detected ordinary peptides were increased when HILIC-sorbents were used together in the stage tips.

REFERENCES

1. Taylor, M. E. and Drickamer, K., "Introduction to Glycobiology", *Oxford University Press*, (2011).
2. Varki, A., Cummings, R. D., Esko, J. D., Freeze, H. H., Hart, G. W., and Marth, J. D., "Essentials of Glycobiology", 2. Ed., *Cold Spring Harbor Laboratory Press*, New York, (2008).
3. Lima, M. and Baynes, J. W., "Glycation", *Encyclopedia Of Biological Chemistry: Second Edition*, 405–411 (2013).
4. Jung, S. T., Kang, T. H., Kelton, W., and Georgiou, G., "Bypassing glycosylation: engineering aglycosylated full-length IgG antibodies for human therapy", *Current Opinion In Biotechnology*, 22 (6): 858–867 (2011).
5. Rodríguez, M., Pujol, M., Pérez, L., Gavilondo, J. V, Garrido, G., Ayala, M., Pérez, M., Bequet-Romero, M., Cabrera, G., and Ramos, O., "Transgenic plants of *Nicotiana tabacum* L. express aglycosylated monoclonal antibody with antitumor activity", *Biotecnología Aplicada*, 30 (2): 157–161 (2013).
6. Reily, C., Stewart, T. J., Renfrow, M. B., and Novak, J., "Glycosylation in health and disease", *Nature Reviews Nephrology* 2019 15:6, 15 (6): 346–366 (2019).
7. Yang, G., Höti, N., Chen, S.-Y., Zhou, Y., Wang, Q., Betenbaugh, M., and Zhang, H., "One-Step Enrichment of Intact Glycopeptides From Glycoengineered Chinese Hamster Ovary Cells", *Frontiers In Chemistry*, 0: 240 (2020).
8. Murakami, H., Sugiyama, T., Miki, Y., Umemura, T., Esaka, Y., Inoue, Y., and Teshima, N., "Development and Evaluation of HILIC-type Sorbents Modified with Hydrophilic Copolymers for Solid-phase Extraction", *Analytical Sciences*, 20P084 (2020).
9. Rachmilewitz, J., "Glycosylation: An intrinsic sign of “danger”", *Self Nonsel*, 1 (3): 250 (2010).
10. Internet: Thermo Fisher Scientific, "Glycosylation", <https://www.thermofisher.com/tr/en/home/life-science/protein-biology/protein-biology-learning-center/protein-biology-resource-library/pierce-protein-methods/protein-glycosylation.html> (2021).

11. Tarihi, G., Özaydin, E., Yalçın, F., Gündüz, M., Köse, G., Çocuk, A., Ve, S., Hematoloji, H., Eğitim, O., Hastanesi, A., and Servisi, Ç., "CONGENITAL DISORDER OF GLYCOSYLATION TYPE II", *Turkish J. Pediatr. Dis*, 6 (1): 2012 (2012).
12. Internet: Mass Spectrometry – Proteomics, "Mass Spectrometry", <https://biomassspec.iyte.edu.tr/instruments/mass-spectrometry/> (2021).
13. Ho, C., Lam, C., Chan, M., Cheung, R., Law, L., Lit, L., Ng, K., Suen, M., and Tai, H., "Electrospray Ionisation Mass Spectrometry: Principles and Clinical Applications", *The Clinical Biochemist Reviews*, 24 (1): 3 (2003).
14. Internet: McMahon, G., "How a Mass Spectrometer Works, Types of Instrumentation and Interpreting Mass Spectral Data", <https://www.technologynetworks.com/analysis/articles/how-a-mass-spectrometer-works-types-of-instrumentation-and-interpreting-mass-spectral-data-347878#D1> (2021).
15. Internet: Creative Proteomics, "MALDI-TOF Mass Spectrometry", <https://www.creative-proteomics.com/technology/maldi-tof-mass-spectrometry.htm> (2021).
16. Internet: MKS newport, "Matrix Assisted Laser Desorption/Ionization (MALDI)", <https://www.newport.com/n/maldi> (2022).
17. Bruins, A. P., "Mechanistic aspects of electrospray ionization", *Journal Of Chromatography A*, 794 (1–2): 345–357 (1998).
18. Banoub, J., "Mass spectrometry, review of the basics: Electrospray, MALDI, and commonly used mass analyzers", *Applied Spectroscopy Reviews*, .
19. Zubarev, R. A. and Makarov, A., "Orbitrap Mass Spectrometry", *Analytical Chemistry*, 85 (11): 5288–5296 (2013).
20. Wührer, M., Deelder, A. M., and Hokke, C. H., "Protein glycosylation analysis by liquid chromatography–mass spectrometry", *Journal Of Chromatography B*, 825 (2): 124–133 (2005).
21. Jensen, P. H., Mysling, S., Højrup, P., Jensen, O. N., and Jensen, O. N., "Glycopeptide enrichment for MALDI-TOF mass spectrometry analysis by Hydrophilic Interaction Liquid Chromatography Solid Phase Extraction (HILIC SPE) Nuclear chaperones View project structure of Hsp View project Chapter 10 Glycopeptide Enrichment for MALDI-TOF Mass Spectrometry Analysis by Hydrophilic Interaction Liquid Chromatography Solid Phase Extraction (HILIC SPE)", *Article In Methods In Molecular Biology*, (2013).
22. Selman, M. H. J., Hoffmann, M., Zauner, G., McDonnell, L. A., Balog, C. I. A., Rapp, E., Deelder, A. M., and Wührer, M., "MALDI-TOF-MS analysis of sialylated glycans and glycopeptides using 4-chloro- α -cyanocinnamic acid

- matrix", *PROTEOMICS*, 12 (9): 1337–1348 (2012).
23. Monagas, M., Quintanilla-López, J. E., Gómez-Cordovés, C., Bartolomé, B., and Lebrón-Aguilar, R., "MALDI-TOF MS analysis of plant proanthocyanidins", *Journal Of Pharmaceutical And Biomedical Analysis*, 51 (2): 358–372 (2010).
 24. Banerjee, S. and Mazumdar, S., "Electrospray ionization mass spectrometry: a technique to access the information beyond the molecular weight of the analyte", *International Journal Of Analytical Chemistry*, 2012: (2012).
 25. Wei, X. and Li, L., "Comparative glycoproteomics: approaches and applications", *Briefings In Functional Genomics*, 8 (2): 104–113 (2009).
 26. Shajahan, A., Heiss, C., Ishihara, M., and Azadi, P., "Glycomic and glycoproteomic analysis of glycoproteins—a tutorial", *Analytical And Bioanalytical Chemistry*, 409 (19): 4483 (2017).
 27. Geyer, H. and Geyer, R., "Strategies for analysis of glycoprotein glycosylation", *Biochimica Et Biophysica Acta (BBA) - Proteins And Proteomics*, 1764 (12): 1853–1869 (2006).
 28. Internet: CAPP, "Sterile Microcentrifuge Tubes", <https://capp.dk/product/expell-microcentrifuge-tubes/> (2022).
 29. Ng, E. W. Y., Wong, M. Y. M., and Poon, T. C. W., "Advances in MALDI mass spectrometry in clinical diagnostic applications", *Topics In Current Chemistry*, 336: 139–175 (2014).
 30. Israr, M. Z., Bernieh, D., Salzano, A., Cassambai, S., Yazaki, Y., and Suzuki, T., "Matrix-assisted laser desorption ionisation (MALDI) mass spectrometry (MS): Basics and clinical applications", *Clinical Chemistry And Laboratory Medicine*, 58 (6): 883–896 (2020).
 31. Sanders, K. L. and Edwards, J. L., "Nano-Liquid Chromatography-Mass Spectrometry and Recent Applications in Omics Investigations", *Analytical Methods : Advancing Methods And Applications*, 12 (36): 4404 (2020).
 32. Li, F., Wang, X., Liu, Y., Liu, H., and Li, Z., "Dephosphorylation of intact glycoprotein to greatly improve digestion efficiency coupled with matrix-assisted laser desorption/ionization–Fourier transform ion cyclotron resonance mass spectrometric analysis", *Analytica Chimica Acta*, 787: 140–147 (2013).
 33. Graves, J. D. and Krebs, E. G., "Protein Phosphorylation and Signal Transduction", *Pharmacology & Therapeutics*, 82 (2–3): 111–121 (1999).
 34. Larsen, M. R., Jensen, S. S., Jakobsen, L. A., and Heegaard, N. H. H., "Exploring the Sialome Using Titanium Dioxide Chromatography and Mass Spectrometry", *Molecular & Cellular Proteomics*, 6 (10): 1778–1787 (2007).

35. Kayili, H. M., Ertürk, A. S., Elmacı, G., and Salih, B., "Poly(amidoamine) dendrimer-coated magnetic nanoparticles for the fast purification and selective enrichment of glycopeptides and glycans", *Journal Of Separation Science*, 42 (20): 3209–3216 (2019).





APPENDIX A.

MALDI-MS SPECTRA FIGURES

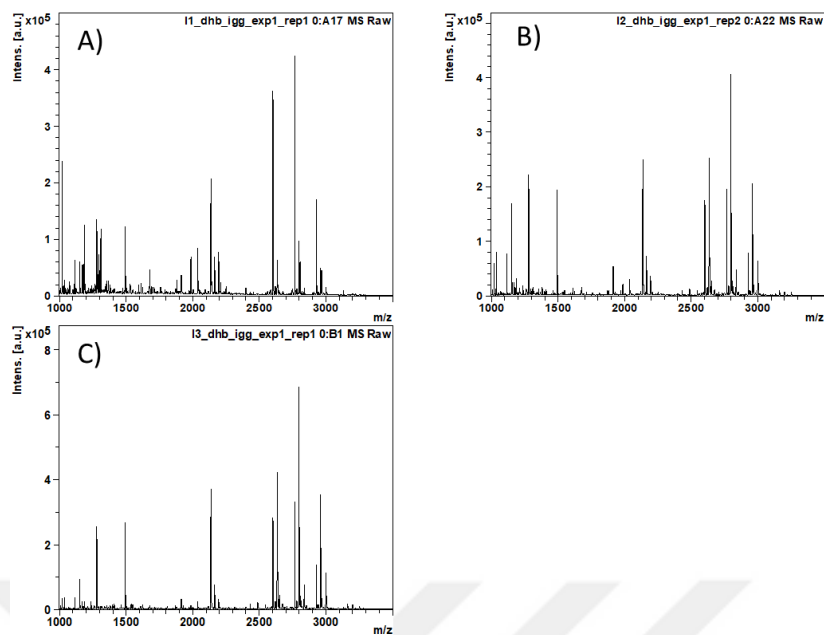

Figure Appendix A.1. MALDI-MS spectra of IgG N-glycopeptides after applied enrichment protocol with cotton stage tips in different elution conditions A) 100% H₂O, B) 90% H₂O 10% ACN, and C) 80% H₂O 20% ACN.

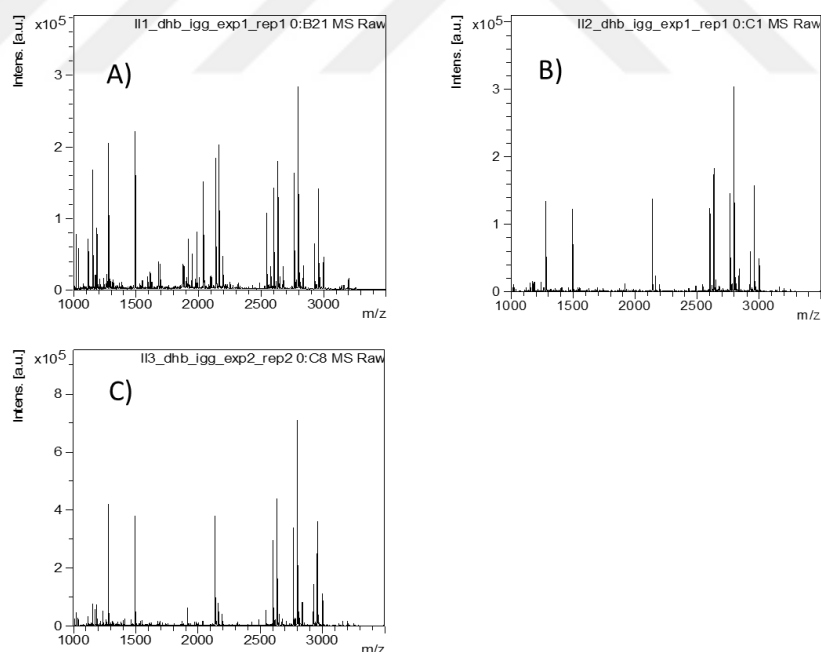

Figure Appendix A.2. MALDI-MS spectra of IgG N-glycopeptides after applied enrichment protocol with cotton + cellulose stage tips in different elution conditions A) 100% H₂O, B) 90% H₂O 10% ACN, and C) 80% H₂O 20% ACN.

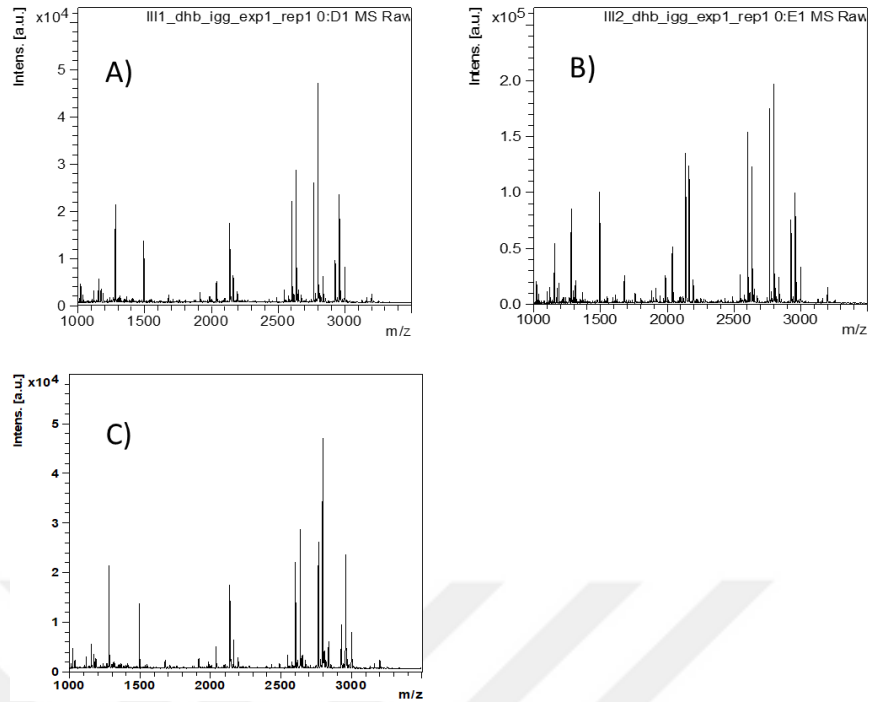

Figure Appendix A.3. MALDI-MS spectra of IgG *N*-glycopeptides after applied enrichment protocol with cotton + sepharose CL-4B stage tips in different elution conditions A) 100% H₂O, B) 90% H₂O 10% ACN, and C) 80% H₂O 20% ACN.

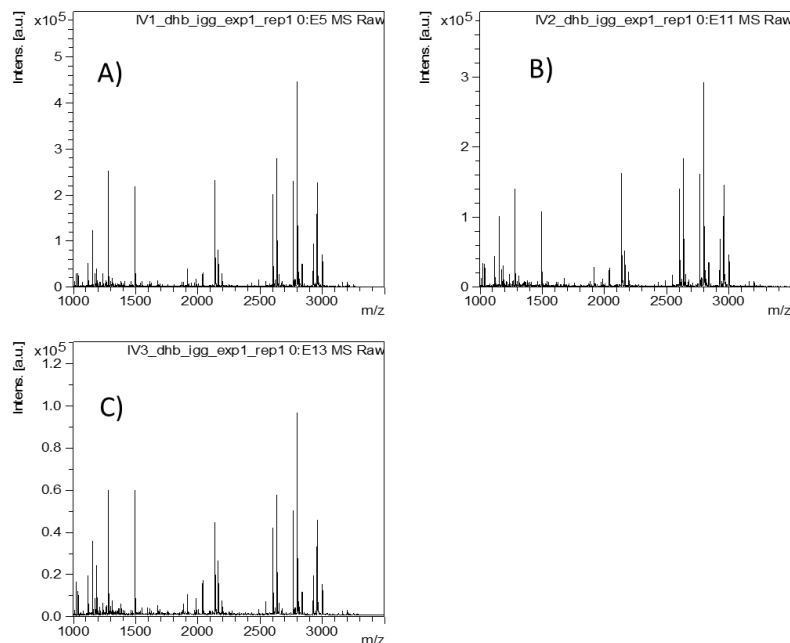

Figure Appendix A.4. MALDI-MS spectra of IgG *N*-glycopeptides after applied enrichment protocol with cotton + cellulose + sepharose CL-4B stage tips in different elution conditions A) 100% H₂O, B) 90% H₂O 10% ACN, and C) 80% H₂O 20% ACN.

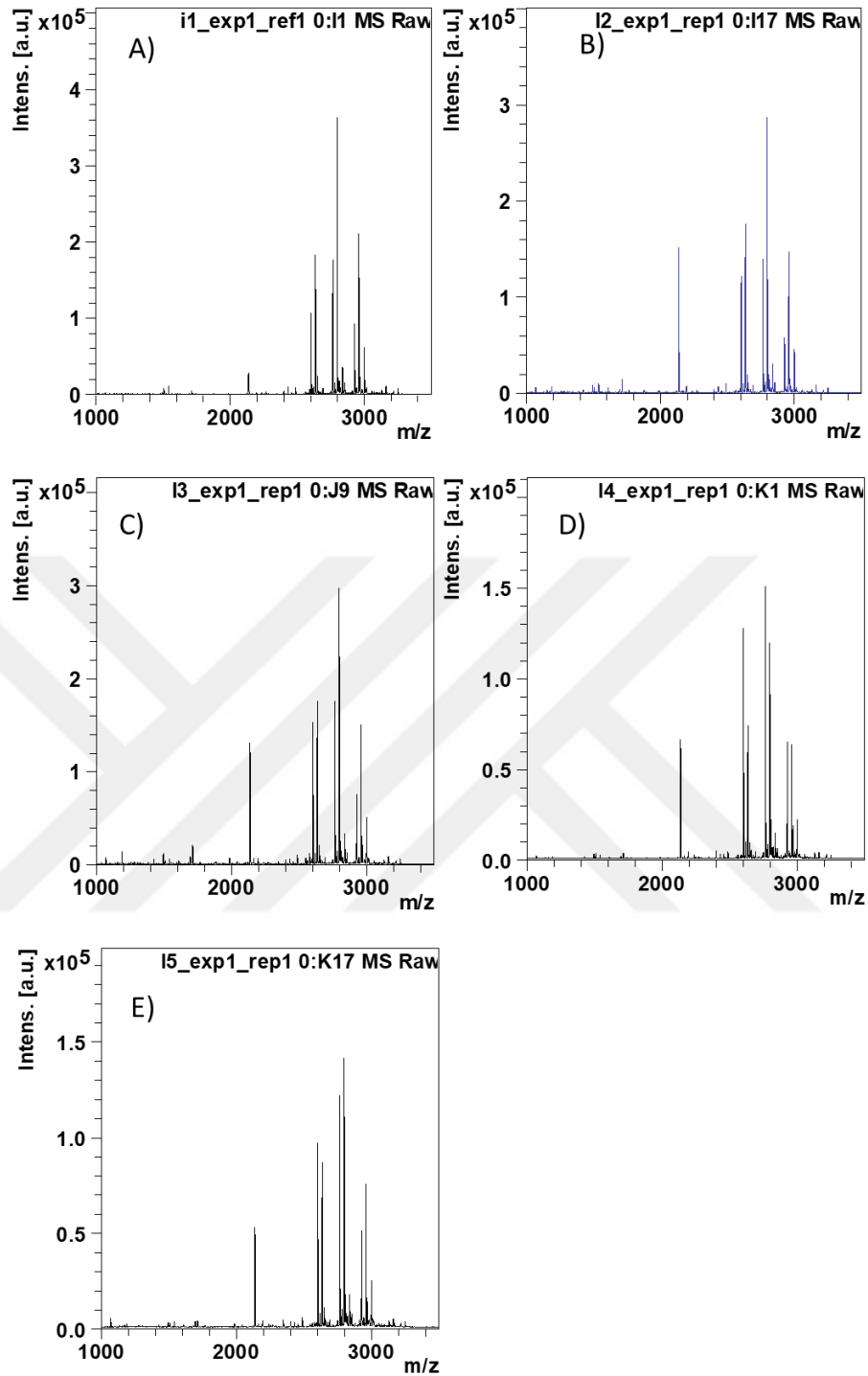

Figure Appendix A.5. MALDI-MS spectra of IgG *N*-glycopeptides after applied enrichment protocol with cotton stage tips in different loading conditions A) 85% ACN 1% TFA, B) 85% ACN 2% TFA, C) 85% ACN 3% TFA, D) 85% ACN 4% TFA, and E) 85% ACN 5% TFA.

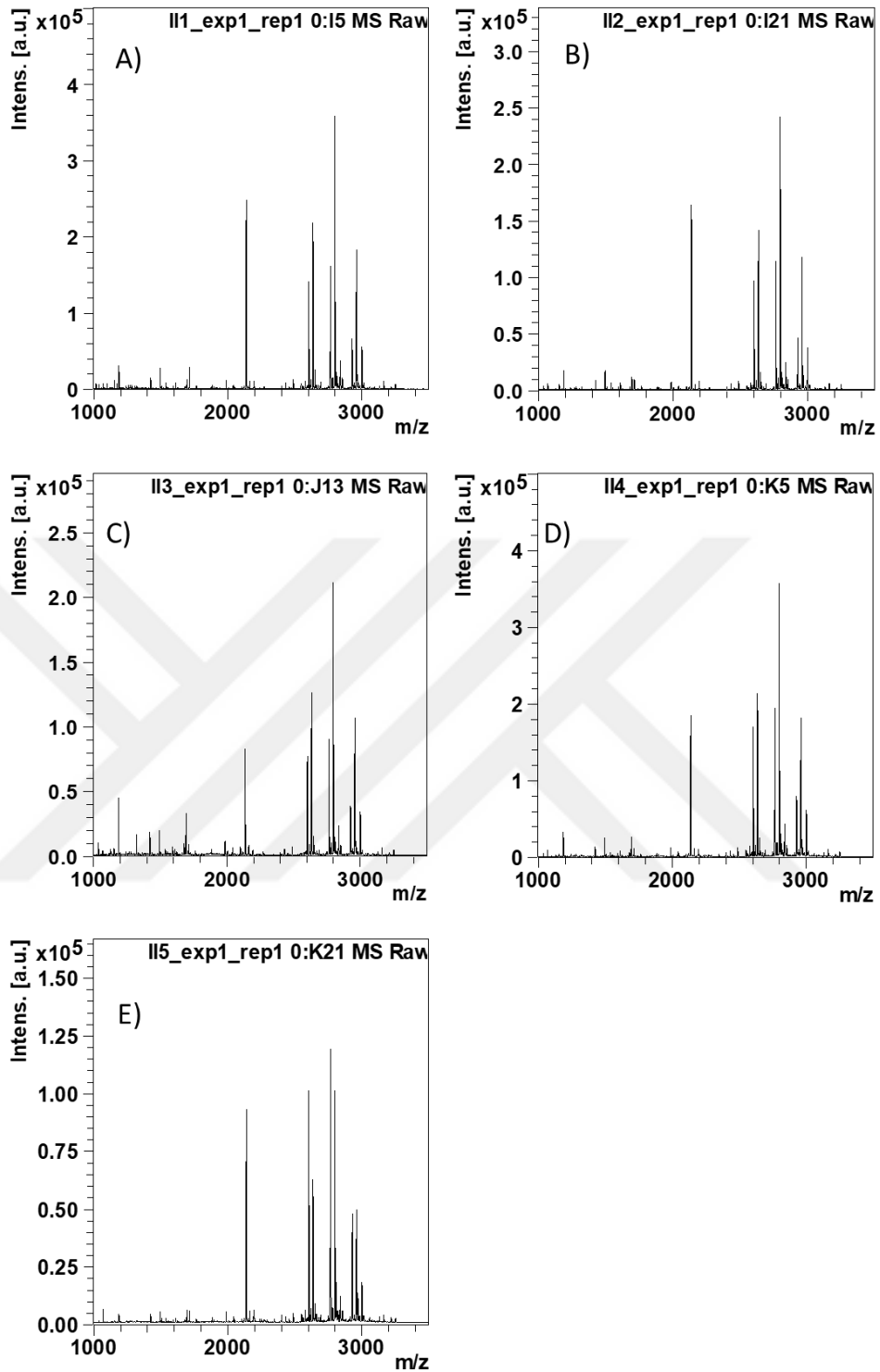

Figure Appendix A.6. MALDI-MS spectra of IgG *N*-glycopeptides after applied enrichment protocol with cotton + cellulose stage tips in different loading conditions A) 85% ACN 1% TFA, B) 85% ACN 2% TFA, C) 85% ACN 3% TFA, D) 85% ACN 4% TFA, and E) 85% ACN 5% TFA.

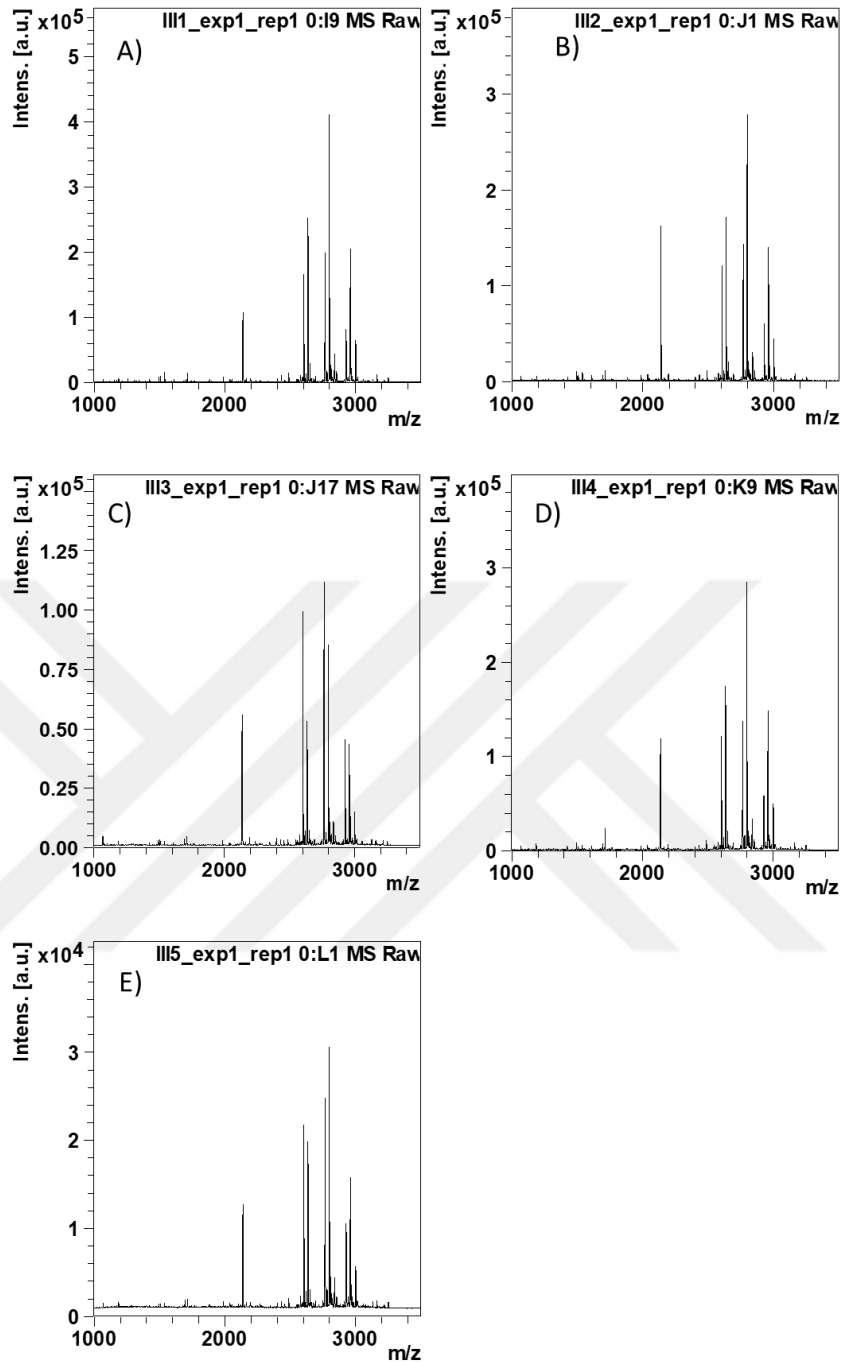

Figure Appendix A.7. MALDI-MS spectra of IgG *N*-glycopeptides after applied enrichment protocol with cotton + sepharose CL-4B stage tips in different loading conditions A) 85%ACN 1% TFA, B) 85%ACN 2% TFA, C) 85%ACN 3% TFA, D) 85%ACN 4% TFA, and E) 85%ACN 5% TFA.

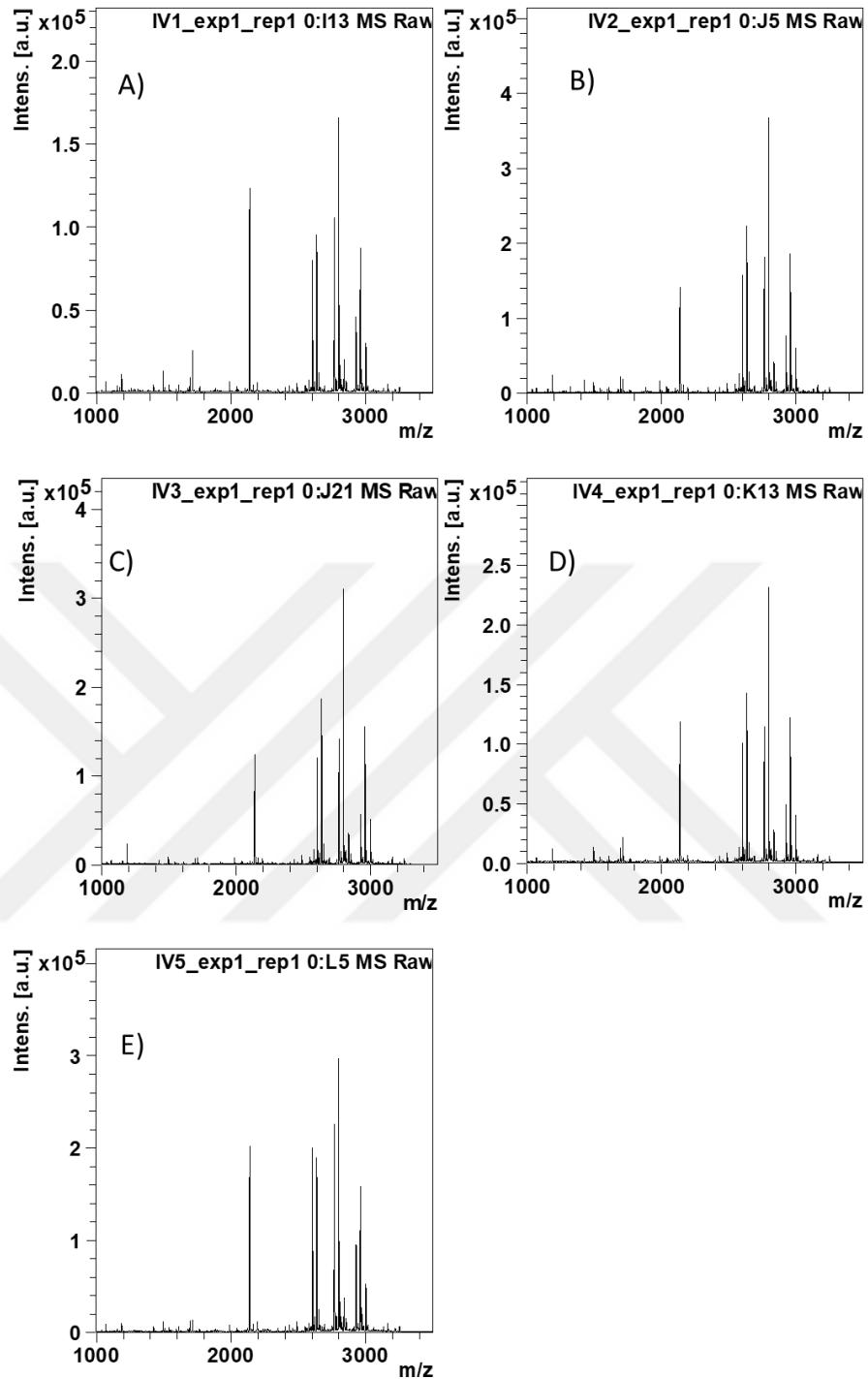

Figure Appendix A.8. MALDI-MS spectra of IgG N-glycopeptides after applied enrichment protocol with cotton + cellulose + sepharose CL-4B stage tips in different loading conditions A) 85%ACN 1%TFA, B) 85%ACN 2%TFA, C) 85%ACN 3%TFA, D) 85%ACN 4%TFA, and E) 85%ACN 5%TFA.

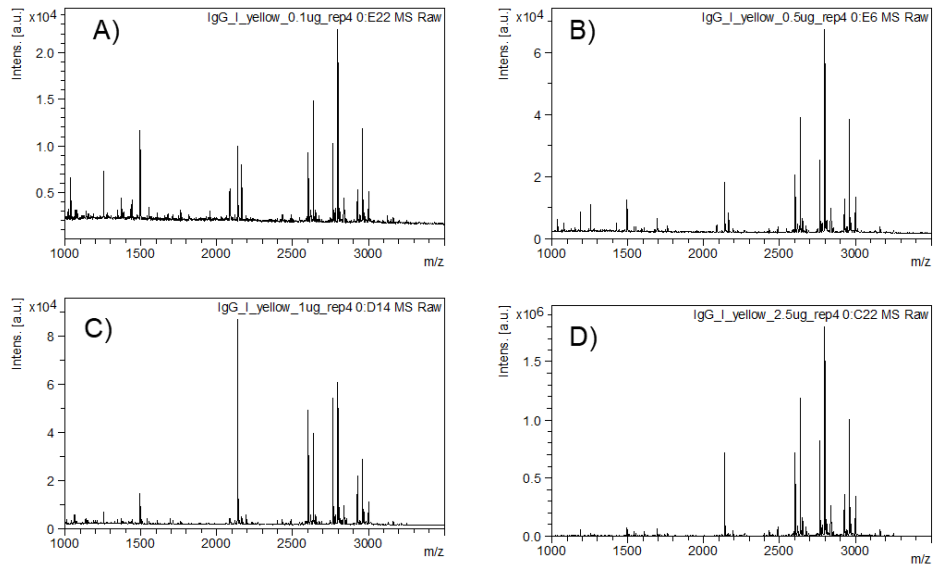

Figure Appendix A.9. MALDI-MS spectra of IgG *N*-glycopeptides after applied enrichment protocol with cotton stage tips using different IgG digests A) 0.1 µg, B) 0.5 µg, C) 1.0 µg, and D) 2.5 µg.

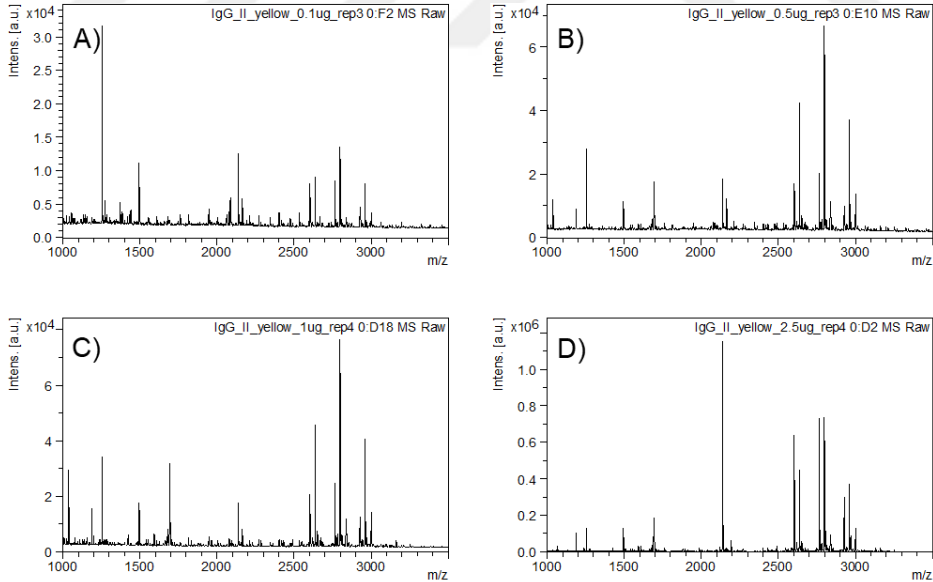

Figure Appendix A.10. MALDI-MS spectra of IgG *N*-glycopeptides after applied enrichment protocol with cotton + cellulose stage tips using different IgG digests A) 0.1 µg, B) 0.5 µg, C) 1.0 µg, and D) 2.5 µg.

Figure A11.

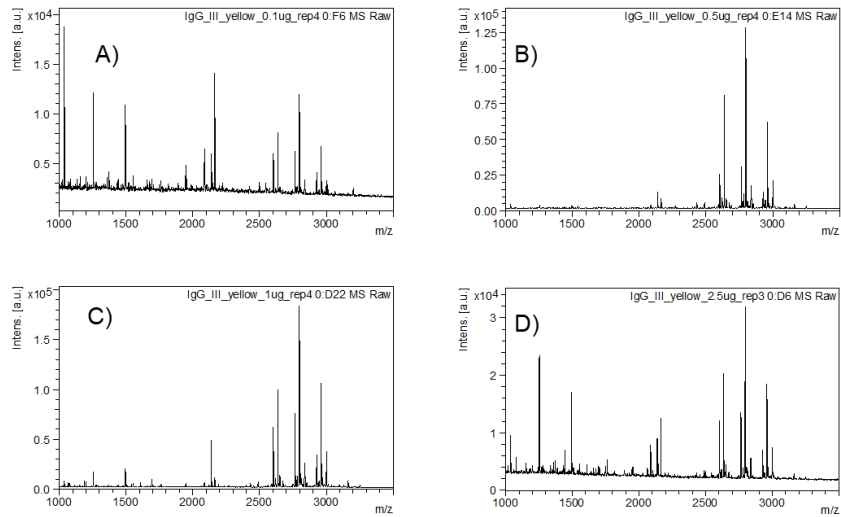

Figure Appendix A.11. MALDI-MS spectra of IgG *N*-glycopeptides after applied enrichment protocol with cotton + sepharose CL-4B stage tips using different IgG digests A) 0.1 µg, B) 0.5 µg, C) 1.0 µg, and D) 2.5 µg.

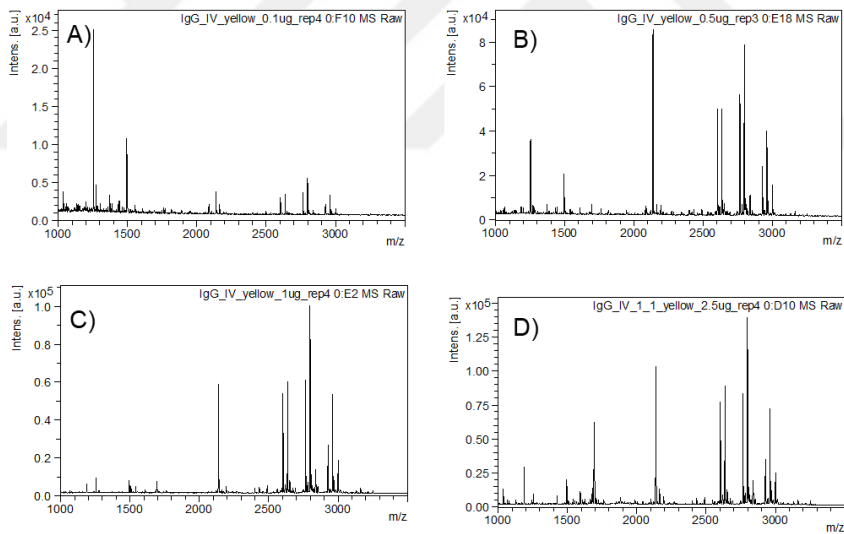

Figure Appendix A.12. MALDI-MS spectra of IgG *N*-glycopeptides after applied enrichment protocol with cotton + cellulose + sepharose CL-4B stage tips using different IgG digests A) 0.1 µg, B) 0.5 µg, C) 1.0 µg, and D) 2.5 µg.