

“TANGENT” ARCHITECTURE: YKKS BUILDING RECONSTRUCTED

A THESIS SUBMITTED TO  
THE GRADUATE SCHOOL OF NATURAL AND APPLIED SCIENCES  
OF  
MIDDLE EAST TECHNICAL UNIVERSITY



BY  
ASLI ALP

IN PARTIAL FULFILLMENT OF THE REQUIREMENTS  
FOR  
THE DEGREE OF MASTER OF ARCHITECTURE  
IN  
ARCHITECTURE

SEPTEMBER 2019



Approval of the thesis:

**“TANGENT” ARCHITECTURE: YKKS BUILDING RECONSTRUCTED**

submitted by **ASLI ALP** in partial fulfillment of the requirements for the degree of **Master of Architecture in Architecture Department, Middle East Technical University** by,

Prof. Dr. Halil Kalıpçılar  
Dean, Graduate School of **Natural and Applied Sciences** \_\_\_\_\_

Prof. Dr. Cânâ Bilsel  
Head of Department, **Architecture** \_\_\_\_\_

Prof. Dr. Ayşen Savaş  
Supervisor, **Architecture, METU** \_\_\_\_\_

**Examining Committee Members:**

Assist. Prof. Dr. Esin Kömez Dağlıoğlu  
Department of Architecture, METU \_\_\_\_\_

Prof. Dr. Ayşen Savaş  
Architecture, METU \_\_\_\_\_

Assist. Prof. Dr. Başak Uçar Kırmızıgül  
Department of Architecture, TEDU \_\_\_\_\_

Date: 11.09.2019



**I hereby declare that all information in this document has been obtained and presented in accordance with academic rules and ethical conduct. I also declare that, as required by these rules and conduct, I have fully cited and referenced all material and results that are not original to this work.**

Name, Surname: Aslı Alp

Signature:

## ABSTRACT

### “TANGENT” ARCHITECTURE: YKKS BUILDING RECONSTRUCTED

Alp, Aslı  
Master of Architecture, Architecture  
Supervisor: Prof. Dr. Ayşen Savaş

September 2019, 73 pages

This work seeks to provide an analysis of the YKKS building designed by *Teğet Mimarlık* architects. Shortly after the inauguration of the Yapı Kredi Art and Culture Center in İstanbul in 2017, the building was immediately recognized in a number of architectural publications in Turkey as well as abroad. Reasons for such earned reputation are various. One of the major interpretations illustrates the building as “negotiating the fine line between preservation and transformation.” ‘fine’ indicating a nuance. This study aims to understand this ‘fine line’ the building negotiates in architectural practice. In line with this purpose, this work, starts with the assumption that it is possible to take a building into consideration and to interpret it with the help of a ‘creative vocabulary’ built around the keyword ‘tangent,’ that will be elaborated for further reading into the selected building.

Keywords: Tangent Architecture, Architectural Criticism, Creative Vocabulary, New into Old, Spatial Transformation

## ÖZ

### “TEĞET” MİMARLIK: YKKS BİNASININ YENİDEN İNŞASI

Alp, Aslı  
Yüksek Lisans, Mimarlık  
Tez Danışmanı: Prof. Dr. Ayşen Savaş

Eylül 2019, 73 sayfa

Bu çalışma, Teğet Mimarlık tarafından tasarlanan YKKS binası üzerine kapsamlı bir araştırma sunmayı amaçlamaktadır. 2017’de İstanbul’da ziyaretçileriyle buluşan bina, açılışının hemen ardından, bir çok ulusal ve uluslararası yayın tarafından fark edildi. Yapının gündem oluşturması ve geniş bir yankı yaratması çok çeşitli sebepler barındırır. Bina hakkında yapılan yorumlardan en öne çıkanı, Yapı Kredi Kültür ve Sanat binasının “koruma ve dönüştürme eylemlerini ince bir çizgi - ‘fine line’- ile ilişkilendirdiğini” öne sürer. Yapının mimarisiyle konumlandığı bu ‘ince çizgiyi’ anlamak ve değerlendirmek amacıyla, bu çalışma bir binayı okumanın ve yorumlamanın anahtar kelime olarak seçilen ‘teğet’ kavramı üstünden üretilen ‘yaratıcı kelime haznesi’ sayesinde mümkün olabileceğini varsayar.

Anahtar Kelimeler: Teğet Mimarlık, Mimari Eleştiri, Yaratıcı Kelime Haznesi, Eski içinde Yeni, Mekansal Dönüşüm

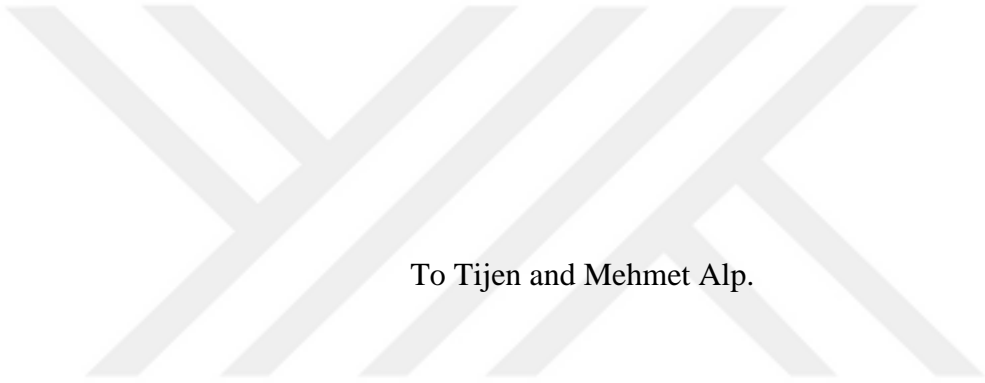

To Tijen and Mehmet Alp.

## ACKNOWLEDGEMENTS

First, I would like to express my special thanks of gratitude to my supervisor Prof. Dr. Ayşen Savaş who always encourage me to do my best. Her generous suggestions and constructive comments led me to complete this work.

Besides, I would like to thank the members of the examining committee: Assist. Prof. Dr. Esin Kömez Dağlıođlu and Assist. Prof. Dr. Başak Uçar Kırmızıgöl for their comprehensive discussions and inspiring comments.

I am indebted to my friends Öykü Acıcan, Selen Karaseyfiöđlu, Ceren Tonkal, Karya Bayır, Nermin Uđur and my dear colleagues for their companionship empathy and motivation throughout the process.

I would like to thank Ilgaz Dođa Okcu for always being there whenever I need.

Finally, I would like to express my deepest gratitude to my family, my mother and my father. I feel very lucky to have such a great family who support me in every step I make.

## TABLE OF CONTENTS

ABSTRACT .....	v
ÖZ .....	vi
ACKNOWLEDGEMENTS .....	viii
TABLE OF CONTENTS .....	ix
LIST OF FIGURES .....	xi
CHAPTERS	
1. INTRODUCTION .....	1
2. YKKS RECONSTRUCTED .....	7
2.1. History of the Plot in the Context of Beyoğlu .....	7
2.2. Old Corner Buildings of the Galatasaray Square .....	12
2.3. The Art and Culture Mission of Yapı Kredi Bank .....	15
2.4. The Architect of the Old YKKS: Paul Schmitthenner .....	16
2.5. The Old Yapı Kredi Bank .....	21
2.5.1. Old Values   Urban Scale .....	21
2.5.1.1. The Arcade .....	21
2.5.1.2. The Old Corner Facades .....	26
2.5.2. Old Values   Building Scale .....	30
2.5.2.1. Structural Order .....	30
2.5.2.2. Structural Space .....	31
2.5.3. Old Values   Detail Scale .....	32
2.5.3.1. Windows .....	33
2.5.3.2. Arcade Columns .....	35
2.5.3.3. Cladding .....	37

3. 'FINE LINE' CHARACTER OF THE YKKS BUILDING .....	39
3.1. Urban Scale .....	39
3.2. Building Scale .....	46
3.3. Detail Scale .....	57
3.3.1. Fine Line Character   Windows .....	58
3.3.2. Fine Line Character   Columns .....	59
3.3.3. Fine Line Character   Cladding .....	60
4. CONCLUSION .....	63
REFERENCES .....	71

## LIST OF FIGURES

### FIGURES

Figure 1.1. Diagrams indicating the extremity between the constant tangent line and an inconstant circle/curve from different scales.....	3
Figure 2.1. Map of Constantinople – the capital and founding city of the Byzantine Empire, drawn in 1422 CE by Florentine cartographer Cristoforo Buondelmonti. This is the oldest surviving map of the city and the only one that predates the Turkish conquest of the city in 1453 CE. ....	7
Figure 2.2. Map illustrates the process of ‘growth’ of İstiklal Street. ....	8
Figure 2.3. Detail from D’ostoya Map of Beyoglu-Pera district, 1858, Teget Architects’ Archive – IBB Atatürk Library .....	9
Figure 2.4. Detail from Huber Map of Beyoğlu–Pera district, Teget Architects’ Archive – IBB Atatürk Library .....	10
Figure 2.5. Detail of the Insurance Map of Istanbul by Ch. E. Goad. Plate 38, September 1905, Teget Architects’ Archive – IFEA Library .....	10
Figure 2.6. Detail from the Prost’s proposal for Beyoglu district, Teget Architects’ Archive.....	11
Figure 2.7. Galatsaray Square, end of 1950s – a photograph taken by Ara Güler.....	12
Figure 2.8. Construction of the Yapı Kredi Bank Building, early 1960s, Teget Architects’ Archive .....	13
Figure 2.9. Expansion of the Yapı Kredi Building with the adjacent building.....	14
Figure 2.10. Detail Drawing of Schmitthenner from the book ‘ <i>Paul Schmitthenner 1884-1972</i> ’.....	19
Figure 2.11. Detail Drawing of Schmitthenner from the book ‘ <i>Paul Schmitthenner 1884-1972</i> ’.....	20

Figure 2.12. The life in arcade space, Places for standing and staying in Ascoli Piceno, Italy, (Gehl, J. (2002). Life between buildings. Beijing: China Architecture & Building Press. p.148).....	22
Figure 2.13. Street view from İstiklal street showing the projections of the facades, digital drawing on photograph from Teğet’s Archive Street view from İstiklal street showing the projections of the facades, digital drawing on photograph from Teğet’s Archive. ....	23
Figure 2.14. The pedestrian flow in the arcade space of the old YKKS designed by Schmitthenner. ....	24
Figure 2.15. The collage work illustrates the conditions with the removed refuge and emplaced Çalık’s sculpture together with the traffic bullets. ....	25
Figure 2.16. Photo diagram showing the traffic refuge. ....	25
Figure 2.17. The collage image showing a possible daily life in front of the arcade space of the old Yapı Kredi Bank.....	26
Figure 2.18. The North-West façade drawing by Schmitthenner, Teğet Archives ...	27
Figure 2.19. The North-West façade drawing by Schmitthenner, Teğet Archives ..	28
Figure 2.20. The North-West façade analysis-digital drawing in reference to the Schmitthenner’ hand drawings. ....	28
Figure 2.21. On the left: the model made according to the drawings and on the right: the model of the constructed building of Yapı Kredi Bank. ....	29
Figure 2.22. On the left: structural orders and on the right: the space division at the ground level by means of the structural elements are illustrated.....	31
Figure 2.23. The concentric space relations of the building are shown with the plan and three-dimensional model.....	32
Figure 2.24. Schmitthenner’s partial façade drawing showing the rectangular windows designed for the old Yapı Kredi Bank building, Teğet Archives .....	34
Figure 2.25. Representation of portrait rectangular by Perret window and ribbon window by Corbusier.....	34
Figure 2.26. A render composition showing the interior viewpoint of the old Yapı Kredi Bank’s rectangular windows. ....	35

Figure 2.27. Circular Arcade columns’ drawn by Schmitthenner, a part of Schmitthenner’s plan and façade drawing, from Teğet Archive. ....	36
Figure 2.28. Arcade columns’ reference axes for the old façade, Schmitthenner’s drawing from Teğet Archive. ....	36
Figure 2.29. Drawing inverted to highlight the order or the Travertine plates on the façade of the old Yapı Kredi Building. ....	38
Figure 3.1. The arcade design of Schmitthenner, which generates an unusual void in the narrowness of İstiklal street. ....	40
Figure 3.2. The first sketches of Mehmet Kütükçüoğlu showing how the design idea developed, courtesy of Teğet Archives. ....	41
Figure 3.3. On the left; the pedestrian flow diagram of Schmitthenner’s arcade and on the right; the pedestrian flow of ‘vertical promenade.’ ....	42
Figure 3.4. The flow of movement limited in the vertical promenade and the proper distance for the visual perception of the interior space indicated both on the plan and section drawings of YKKS. ....	43
Figure 3.5. Transparent quality or the quality of the transparency of the spatial organization of the YKKS in reference to the spatial a painting by Le Corbusier. (Bernhard Hoseli in “Kommentar und Addendum). ....	44
Figure 3.6. The section illustrates the spatial relation of the ground level with street and the plan represents the movement flow between the street and the building. ....	45
Figure 3.7. The superimposition of the old Yapı Kredi Bank’s and YKKS building’s structures. ....	47
Figure 3.8. The diagram demonstrating the spatial organization of floor levels of the YKKS building. ....	49
Figure 3.9. Plan, section and photographs showing the visual connection provided at the defined spot A. ....	50
Figure 3.10. Plan, section and photographs showing the visual connection provided at the defined spot B. ....	51
Figure 3.11. Plan, section and photographs showing the visual connection provided at the defined spot C. ....	52

Figure 3.12. Plan and photographs showing the visual connection provided at the defined spot A on the second floor. ....	53
Figure 3.13. Plan and photographs showing the visual connection provided at the defined spot B on the third floor. ....	54
Figure 3.14. Plan and photographs showing the visual connection provided at the defined spot A on the fourth floor. Courtesy of Teĝet Archives. ....	55
Figure 3.15. Plan and photograph showing the visual connection provided at the defined spot A on the fifth floor. Courtesy of Teĝet Archives. ....	56
Figure 3.16. Photograph showing the provided visual connection on the top floor. Courtesy of Teĝet Archives. ....	57
Figure 3.17. Photographs showing the interior surface of the preserved street-facing façade. ....	58
Figure 3.18. Diagrams illustrating the changing solid and void perception of the street façade for an observer. ....	59
Figure 3.19. Diagrams illustrating the changing solid and void perception of the street façade for an observer. ....	60
Figure 3.20. Photograph showing the cladding strategy of YKKS building, courtesy of Teĝet Archives. ....	61
Figure 4.1. Studies for the Cabriole legs (Venturi, R., <i>The Obligation Toward the Difficult Whole</i> , in: <i>Complexity and Contradiction in Architecture</i> , p.88-105) .....	66

## CHAPTER 1

### INTRODUCTION

This research mainly focuses on a recently reconstructed building designed by Teğet Architects. Opened in 2017, Yapı Kredi Art and Cultures Building has become one of the trending topics in both national and international architectural literature. It has been presented as a winner project in the special issue of the Architectural Review, ‘New into Old’<sup>1</sup> that promotes projects which create a new space to think about transformation through preservation. Paul Finch, in his editorial to the said issue of the AR quotes T.S. Eliot:

*“A play should give you something to think about. When I see a play and understand it the first time, then I know it can’t be much good.”*<sup>2</sup>

What Finch attempts to describe with this quote is the value of a work of art that provokes to be understood and talked about. In order to understand how Teğet Architects managed to set the new YKKS edifice inside the old structure, this research aims to devise a ‘creative vocabulary’ to guide deliberations on the YKKS building, to understand its architectural design, which shall also facilitate further interpretations. With the aim of inventing such a creative vocabulary, this study embraces the term ‘tangent’ as the bedrock of this vocabulary. ‘Tangent’ (*teğet* in Turkish) is a

---

<sup>1</sup>Architectural Review magazine launched the AR New into Old awards in 2017 to celebrate the creative ways buildings are adapted and remodeled to welcome new, contemporary uses and to recognize the imaginative appropriation of existing structures, from innovative insertions to ambitious adaptations, that offer buildings a new lease of life.

<sup>2</sup>Finch, P. (2017, December). All architecture is about the future – but about the past too. *The Architectural Review*, 1447, p. 2, opening speech (quotation is retrieved from: T. S. ELIOT, *New York Post*, September 23, 1963)

mathematical term which also alludes to a ‘fine line’<sup>3</sup> that merely touches a circle without penetration.<sup>4</sup>

In mathematics tangent is used to study the exact behavior of graphics at each little point and every section.<sup>5</sup> The researchers have studied the concept ‘tangent’ by accepting the elements of the concept of a ‘tangent’ as a tangent line and a space curve. . Because the aim of a tangent line was to learn about an inconstant curve, the angle and the direction of a tangent line which had to be constant values. Therefore, it is possible to interpret that the concept of ‘tangent’ ‘inherits duality’ by means of its elements: one that has to be constant and the other inconstant. In addition to that, Greek mathematician Euclid refers to the term tangent in the Book III of the Elements (300 BC). He claims that any line drawn at right angles to the diameter of a circle at its extremity is a tangent to the circle.<sup>6</sup> This definition allowed the geometers to understand that ‘extremity’ as the most intense degree between a curve and the straight line. After Euclid, Apollonius, a Greek geometer and astronomer, defines ‘extremity’ as a moment that no other straight line could fall between it and the curve.<sup>7</sup> Which means although the tangent line does not intersect with the curve, it seems as if they

---

<sup>3</sup>Kafka, G. 2017, December. *The Architectural Review*, 1447, p.10. In the opening statement of the winner Yapı Kredi Culture Centre, George Kafka uses the phrase “fine line” in order to express the building’s outstanding architectural success. He asserts: “Teget’s treatment of the Yapı Kredi Culture Centre in Istanbul negotiates the fine line between preservation and transformation.”

<sup>4</sup>Schwartzman, S. (2012). *The Words of Mathematics: An Etymological Dictionary of Mathematical Terms Used in English*. Cambridge: Mathematical Association of America. Retrieved from <http://0-search.ebscohost.com.library.metu.edu.tr/login.aspx?direct=true&AuthType=ip&db=nlebk&AN=450262&site=eds-live>

<sup>5</sup>Schwartzman, S., Mathematical Association of America. (1994). *The words of mathematics: An etymological dictionary of mathematical terms used in English: a reference book describing the origins of over 1500 mathematical terms used in English, including a glossary that explains the historical and linguistic terms used in the book*. Washington, D.C: Mathematical Association of America.

<sup>6</sup>Euclid, & Playfair, J. (0002). *Elements of geometry: Containing the first six books of Euclid, with a supplement on the quadrature of the circle, and the geometry of solids: to which are added, Elements of plane and spherical trigonometry*. Whitefish, MT: Kessinger Publishing., pp.73

<sup>7</sup>Heath, T. L. (2010). *Apollonius of Perga: Treatise on conic sections*. Milton Keynes, UK: Lightning Source. p.22

have contact. This proved that in order to be able to understand the exact relation between a tangent line and a curve, there is a need to ‘reduce the distance’ and examine the relation from a larger scale.

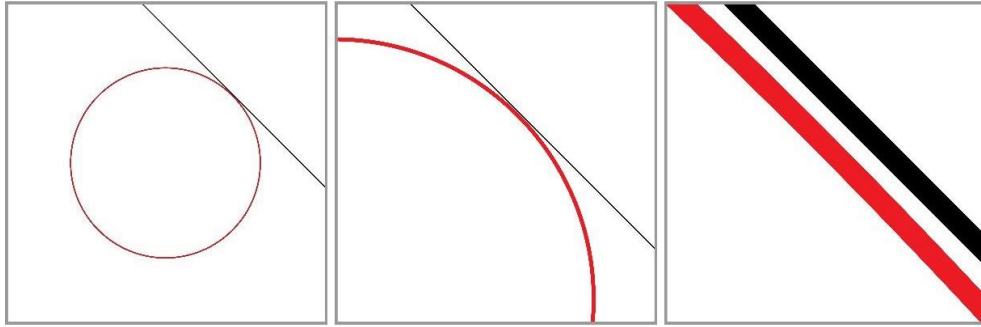

Figure 1.1. Diagrams indicating the extremity between the constant tangent line and an inconstant circle/curve from different scales.

Apart from being a mathematical term which offers qualities that can be used to understand the ‘fine line’ character of the building, interestingly ‘tangent’ has become one of the preferred concepts by Teğet Architects, reflecting both their architectural design practices and the footing of the office in the world of architecture. In an interview, the founder of the Teğet architects, Mehmet Kütükçüoğlu draws an analogy between a tangent line in mathematics and the position of the office in the current commercial architectural environment in Turkey. In his own words:

“We are neither inside or the outside of the circle but tangent to it.”<sup>8</sup>

In another interview, Kütükçüoğlu constructs yet another parallel between a tangent line and the significance of the office. The way he describes the critical position of the office between theory and practice, actually originates from how the selection of assigned projects is made. His description of this position is as follows:

---

<sup>8</sup>Yüksel, H. Z. (2013, November). Interview with Mehmet Kütükçüoğlu on Marine Museum, Art and Design Magazine, no: 44, p. 26

“We aim not to specialize on a specific building type, but always we look for a new opportunity to challenge, a new case to deal with. This approach of course more effort-demanding but it is worthy still.”<sup>9</sup>

In an interview with the editors of the architectural platform, *Mimarizm*, Associate Ertuğ Uçar also avails of the very same the term to express his ideas on architectural practice. Uçar says:

“Recently I was reading Enis Batur. I was touched by the way he defines the problem of an intellectual in Turkey. Then, I thought that this problem was ‘a problem of topography,’ that can also be problematic for the architects in this part of the world, where nobody knows where to stop. Nobody knows where the cliff is. Hence the condition of being tangent.”<sup>10</sup>

As mentioned above, this study aims to understand the ‘fine line’ character of the building with the help of a creative vocabulary burgeoning around the concept of ‘tangent.’ With this aim the major elements of the creative vocabulary, are determined as: the inherent duality, the reducing distance and the extremity which makes the term ‘tangent’ an absolute concept for the further readings of the selected building. While the study focuses on tapping into the building’s ‘fine line’ character, it also uses the creative vocabulary to answer three questions: ‘What is old and what is new?’, ‘to which extent the old and the new values should be evaluated?’ and ‘whether or not the negotiation between the old and the new values can be interpreted as a successful togetherness?’ In Chapter 2, the study seeks to look into the question, ‘What is old and what is new?’ by using the first element of the creative vocabulary, that is the **inherent duality**. Inherent duality in the study of the ‘tangent’ refers to define the constant and

---

<sup>9</sup>VBenzeri (Producer). (2017, December 8). Interview with Teğet Founders on Marine Museum and Yapı Kredi Art and Culture Centre. Retrieved from <https://www.vbenzeri.com/video/teget-mimarlik>

<sup>10</sup>Yavuz, F., Tufan, M. (2008, May). Interview with Mehmet Kütükçüoğlu and Ertuğ Uçar, Mimarlık ‘mesleği’ ve ‘işi’ arasında büro, *Mimarizm*, Retrieved from [https://www.mimarizm.com/makale/mimarlik-meslegi-ve-isi-arasinda-buro\\_113576](https://www.mimarizm.com/makale/mimarlik-meslegi-ve-isi-arasinda-buro_113576)

the inconstant parameters in a tangent graph in order to comprehend the relation which is intended to be constructed. This study accepts that, as in the case of the tangent graph, inherent duality also exists as a quality in the architectural design of the selected building. Therefore, it offers to decompose the building into its elements, by differentiating the old and the new values. In the process of decomposition of the existing building to bring about a definition of the old and the new, it is essential to know about the history of the old headquarters of the Yapı Kredi Bank, designed by Schmitthenner. In this respect, firstly, Schmitthenner as a German architect of the Nazi era is examined by means of his rationalistic architectural style and then the architectural values of the old Yapı Kredi building.

Finally, Chapter 3, handles the remaining questions as ‘to which extend the old and the new values should be evaluated?’ and ‘whether or not the negotiation between the old and the new values can be interpreted as a successful togetherness?’ will be researched. Zumthor states that, ‘details express what the basic idea at the relevant point in the object are: belonging or separation, tension or lightness, friction, solidity or fragility.’<sup>11</sup>

Zumthor states that the scale of detail inherits the essence of design idea. At this point the distance reducing quality of the term ‘tangent’ is used to trail a path through the building’s scale of detail. This quality of the term, concerns with the infinitely small part of a curve by reducing the distance. This study uses this quality of the term as a key to define the extent of analysis. Therefore, old and the new values are dissected starting from the urban, then the building and then all the way down to the scale of detail. The preferred methodology to reduce the distance through building’s scale of the building, gives the opportunity to understand the negotiation between the old and the new values in various contexts. The changing environments in every scale provide different **extremities**, extremity as another bold quality of the term tangent, is being interpreted as the parts of the building, where the old and the

---

<sup>11</sup>Zumthor, P. (2010). Thinking architecture. Basel: Birkhause, p.16

new values merge within an intense relationship. For this reason, the answer of the question ‘whether or not the negotiation between the old and the new values can be interpreted as a successful togetherness?’ is evaluated in view of these extremities. This study is an inquiry into the ‘fine line’ character of the YKKS building in reference to the creative vocabulary that evolves around the term ‘tangent’. Therefore, the study can be evaluated not only as an inquiry of a building but also as a research into a new vocabulary used to talk about a building.



## CHAPTER 2

### YKKS RECONSTRUCTED

#### 2.1. History of the Plot in the Context of Beyoğlu

İstiklal Street, one of the most important arteries in İstanbul, dates back to Byzantine period. There is no doubt that the street can be considered as the backbone of the Beyoğlu district. Throughout İstanbul's history, it has undergone many cultural as well as physical changes. From the Byzantine to the Roman and to the Ottoman Empire, many cultures have contributed to the formation of its contemporary identity.



Figure 2.1. Map of Constantinople – the capital and founding city of the Byzantine Empire, drawn in 1422 CE by Florentine cartographer Cristoforo Buondelmonti. This is the oldest surviving map of the city and the only one that predates the Turkish conquest of the city in 1453 CE.

In the beginning of 18<sup>th</sup> century, İstiklal street extended between the Galata

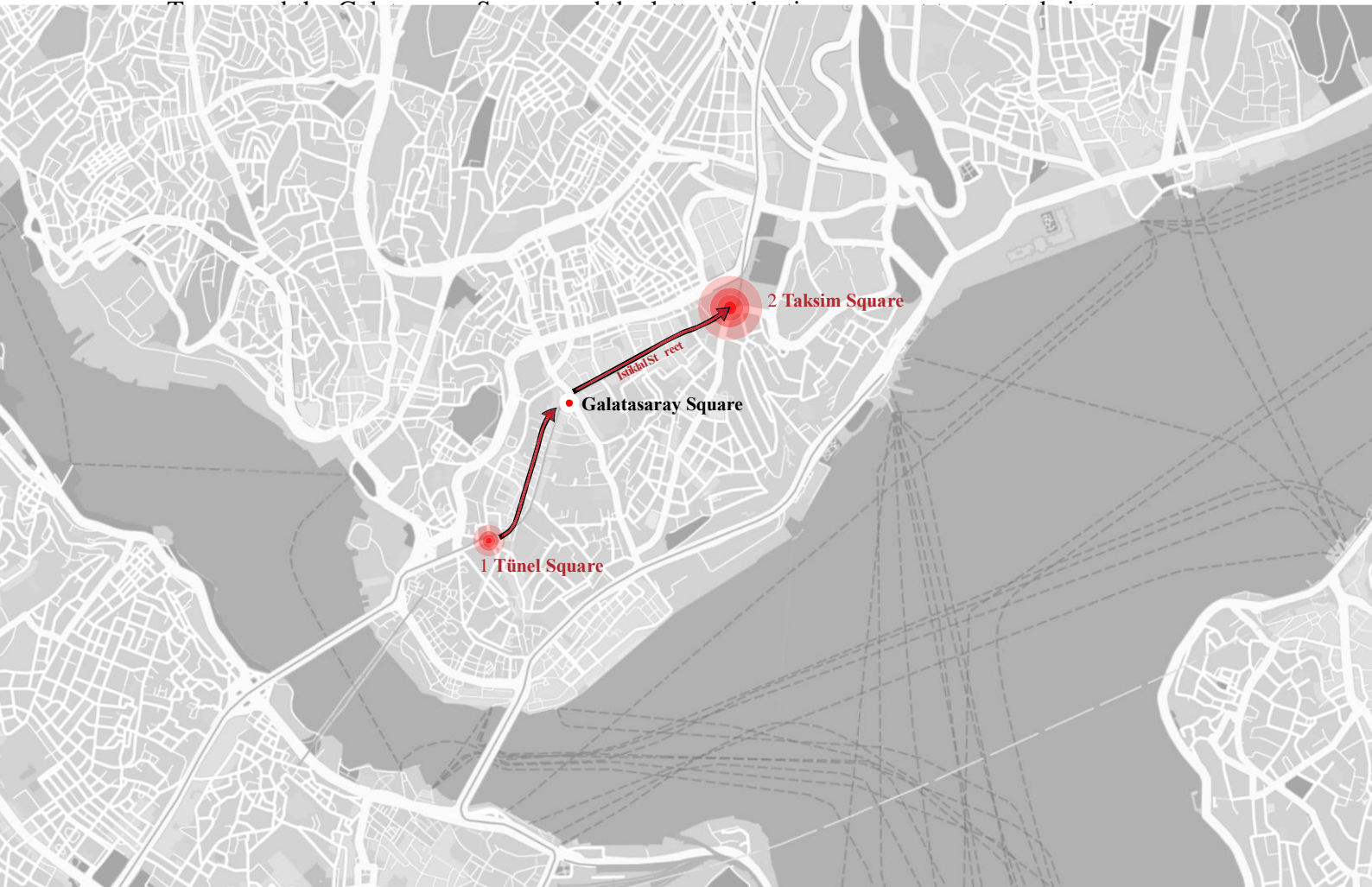

The process whereby İstiklal Street developed showcases how Galatasaray square has become representative of the concentration of different timelines as well as different orientations. It can be said, due to its critical location, that this area is the most affected by the mercurial conditions of that period prevalent in İstiklal Street. In the book ‘An opening to the city,’ editors highlight two important breaking points which have transformed the plot to its present conditions.<sup>13</sup> First is considered as the

---

<sup>12</sup>Tekeli, I., & Eyice, S. (1994). *Dünden bugüne İstanbul ansiklopedisi: Volume 3*. Istanbul: publication of the Ministry of Culture and History Foundation.

<sup>13</sup> Kütükçüoğlu, B., & Bugatti, E. (2019, April). *An Opening to the City*, Yapı Kredi Publications, p.59-

fire that broke near Taksim Square, destroying more than three thousands buildings in 1870. In the master plan dates back to the 1858, the corner spot of the today YKKS, hosts small building blocks which are facing Galatasaray Police station. As seen from the master plan the spot hasn't yet formed as a potential public square.

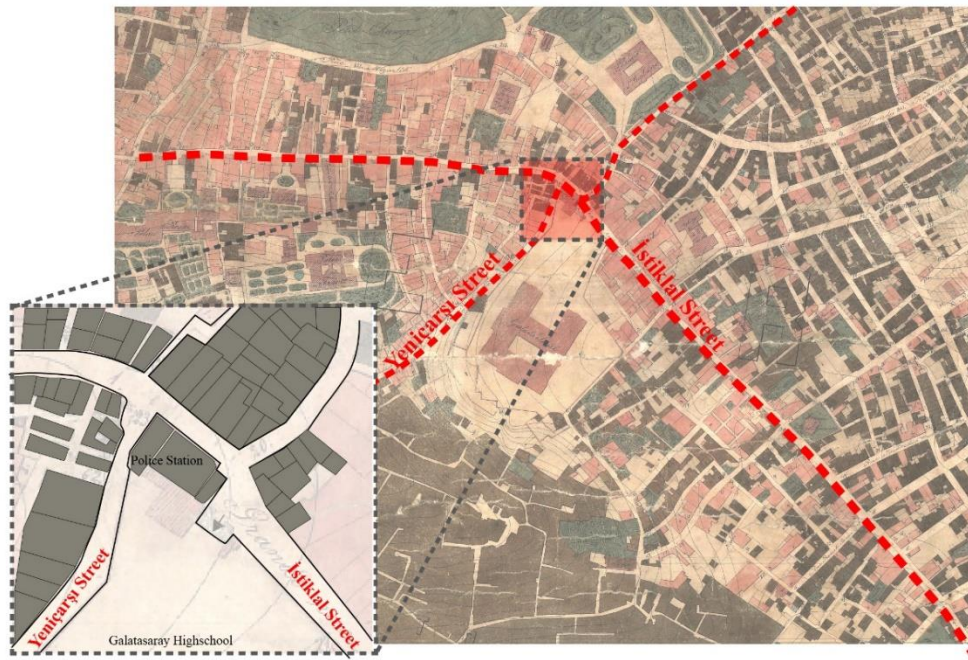

Figure 2.3. Detail from D'ostoya Map of Beyoglu-Pera district, 1858, Teget Architects' Archive – IBB Atatürk Library

After the devastating fire, the part of İstiklal Street that lies between the spot concerned and Taksim Square, was enlarged and remodeled with residential and commercial building blocks. Huber's map is very-well-descriptive of how the two parts of İstiklal Street that flowed on axes of varying widths have clashed. The increasing width from seven meters to eighteen meters led to a rethinking of the scale of new buildings to come.

Changing scales of buildings transformed small wooden blocks into the more compact buildings. In the insurance map prepared by Goad, a corner building facing both İstiklal Street and the Galatasaray Square can be seen, which was to be replaced by today's YKKS.

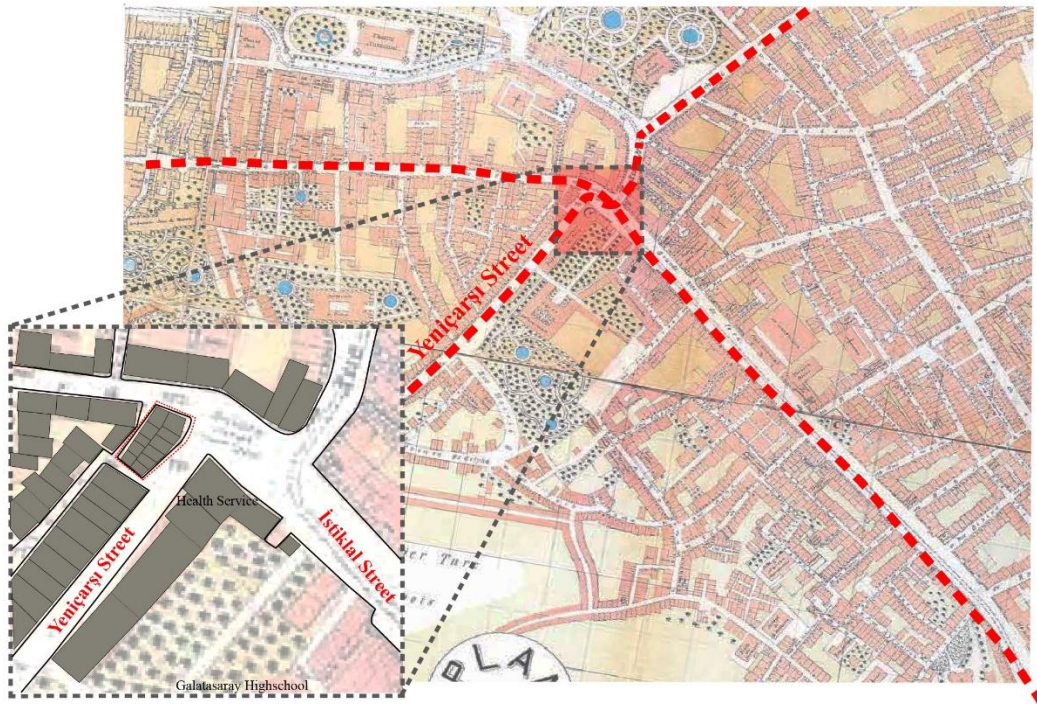

Figure 2.4. Detail from Huber Map of Beyoğlu-Pera district, Teğet Architects' Archive – IBB Atatürk Library



Figure 2.5. Detail of the Insurance Map of Istanbul by Ch. E. Goad. Plate 38, September 1905, Teğet Architects' Archive – IFEA Library

Another important transformation which has changed the character of the Galatasaray spot, for Burcu Kütükçüoğlu and Emiliano Bugatti, is the disappearance of the police station. It is obvious that, the station was narrowing the Yeniçarşı street and prevented the perception of a potential square while constraining the view of the corner spot. They claim that with the demolition of these buildings, ‘a new open area, which was not a street space anymore but not a square either’<sup>14</sup> was created the Turkish Republic fledged.



Figure 2.6. Detail from the Prost’s proposal for Beyoğlu district, Teget Architects’ Archive

The very first sketches of today’s corner spot can be seen in the old İstanbul Master plan by Henri Prost dated 1937.<sup>15</sup> The faded part of the drawing can be reckoned as a sign of a search to reshape the corner with a new corner building.

---

<sup>14</sup>Kütükçüoğlu, B., & Bugatti, E. (2019, April). *An Opening to the City*, Yapı Kredi Publications, p.66

<sup>15</sup>Derrek H.F. Ho (2014, December). *Istanbul (1936-1951) / The Regeneration of Beyoğlu District*. Asian Cities Research, Retrieved from <https://dx.doi.org/10.0000/0000>

## 2.2. Old Corner Buildings of the Galatasaray Square

Before the dramatic fire in 1870, in 1858 in D'ostoya's map, it can be seen that the corner was full of fragmented buildings. Even though, from Goad's map, we know that the corner where the YKKS stands today was reconsidered for a single building, as witness-framed by Ara Güler.



Figure 2.7. Galatsaray Square, end of 1950s – a photograph taken by Ara Güler

In the above photograph, it can be seen that the single block called 'Galata Serai Apparts' hosts six shops on the ground floor along Yeni Çarşı street. When and by whom this building was constructed is not known but the projected windows, the cornices along the floor ends and the arch shape pediments, indicate that it can be accepted as Levantine.<sup>16</sup> In 1958, German architect, Paul Schmitthenner was commissioned to design a new building as the headquarters of Yapı Kredi Bank where

---

<sup>16</sup>Kütükçüoğlu, B., & Bugatti, E. (2019, April). *An Opening to the City*, Yapı Kredi Publications, p.71

the Levantine building stood. After the demolition of the old apartment building, construction of an office complex commenced, which was to be designed by Schmitthenner and completed in early 1960s.



Figure 2.8. Construction of the Yapı Kredi Bank Building, early 1960s, Teget Architects' Archive

In 1992, YKKS (Yapı Kredi Culture and Arts), started to operate in the building. Space that overflowed due to increasing arts and cultural activities, brought minds to the idea of adding an adjacent building to the existing one. Thanks to this expansion, the Vedat Nedim Tör Museum, a library, a gallery, a publishing department and a book store could find a home at the building. The additional façade of the adjacent building was changed and the façade composition of the Schmitthenner's building was continued in the same order and cladded with the same material – travertine- alongside the İstiklal Street in observance of the design by the commissioned architect, Bülent Marmara.<sup>17</sup>

---

<sup>17</sup>Ibid, p.72



Figure 2.9. Expansion of the Yapı Kredi Building with the adjacent building.

When the ownership status of the annex has changed, Yapı Kredi decided that it needed a new design for a new building to marry the existing functions with a new volume and a facade.<sup>18</sup> Understanding the concern of Yapı Kredi Bank for a new *visage* to veil over arts and cultural activities, is one of the essentials to evaluate the new building's architectural design by Teğet Architects. Therefore, in the next chapter the art and culture mission of the Yapı Kredi Bank will be elucidated by looking into its history since its foundation.

<sup>18</sup>Kütükçüoğlu, M. & Uçar, E. (2017, November). Interview by Yüksel, H. Z. Binadan Öte Bir Şehir Mekanı. *İstanbul Art News*, Retrieved from <https://www.arkitera.com/soylesi/991/binadan-ote-bir-sehir-mekani>

### 2.3. The Art and Culture Mission of Yapı Kredi Bank

Yapı Kredi Bank was founded by Kazım Taşkent in 1944. At the opening speech Taşkent especially underlined the mission of the bank:

*“The institutions like us have two major responsibilities. First is to deal with its own issues, the second is to work also for the benefit of society. We chose art and culture.”*<sup>19</sup>

So, that is how Yapı Kredi Bank established Yapı Kredi Kültür Sanat ve Yayıncılık (Yapı Kredi Arts Culture and Publishing) in 1945. The aim was to enrich the cultural and artistic knowledge and so on a national scale. YKKS started to publish magazines, books and to collect special art pieces in its archives immediately after its establishment.

However, the purpose of the mission regarding arts and culture has changed after Çukurova Group which is one of the biggest corporation in Turkey’s industrial sector, took over the administration of Yapı Kredi Bank (YKB) in 1980. With this change the bank continued its publishing and art collector’s identity but commenced to use arts and cultural activities as the tools to make-up its image. In 2005, YKB administration changed hands again. The cooperation of Koç Group and UniCredit one of the largest company which was founded in 1926 in Turkey the other one established in 1473 in Europe, respectively, the bank’s image for the bank, i.e. the YKB, has become a more important issue.<sup>20</sup> The architectural competition, in 2010, for a new building to house YKKS, could be considered as an obvious proof how the bank strategized to strengthen its image. Following the competition in 2010, the architectural proposal by Teğet Architects was accepted by the YKKS committee for

---

<sup>19</sup>Ersel, H. (2014). *Kazım Taşkent, Yapı Kredi ve Kültür Sanat*. İstanbul: Yapı Kredi Yayınları.

<sup>20</sup>Kardeş, E. (2015). *Türkiye’de Özel Sektörün Kültür Yatırımları ve Sosyal Sermaye: Yapı Kredi Örneği. (The Cultural Investments of the Private Sector in Turkey and Social Capital: The Yapı Kredi Example)*. Unpublished master’s thesis, İstanbul Bilgi University, Turkey.

it provided more space, attracted more masses and displayed a contemporaneous face that could reflect the foundation's position in today's cultural habitat.

Designers of Teğet evaluated the demands of the commission and added new missions to the design. Although the office was free to demolish the existing building and to construct a new one, the decision was to work with the existing building. As Kütükçüoğlu explains, “We used this as a provocation to the common practice in the city, where things are being built from scratch over and over again. The new administration is not tolerant to what is old, unless it goes back a hundred years or more, so you almost lose your childhood every time the city changes skin every twenty, thirty years.”<sup>21</sup>As understood from this statement by Kütükçüoğlu, Teğet rejected to erase the memory of a building which stands at one of the most important corners of the İstiklal street. The decision to work with the historic materials already in place in an entirely new way required a research of the building's history and the plot. Also, with the aim to make use of old values, the architect of the old Yapı Kredi Bank was also an important figure to research.

#### **2.4. The Architect of the Old YKKS: Paul Schmitthenner**

A building as an object represents more than its mere self. In this respect the complexity of the interwoven layers of the past should be analyzed starting from the origin of the architectural object. The architect of the old YKKS building, Schmitthenner uses the term “Baugestaltung” i.e. –‘tectonic conception’ of the building, in order to express the representational form and the construction of a building. <sup>22</sup> Etymologically speaking the term consists the words ‘Bau’ and ‘Gestaltung’ in German. ‘Bau’ means; construction, building, while ‘Gestaltung

---

<sup>21</sup>By George Kafka and Juan Du, Opening statement: Yapı Kredi Culture Centre in Istanbul by Teğet, The Architectural Review, 14 December 2017

<sup>22</sup>Ardito, V. (2014). Baukunst and the project of the construction's form. Research and didactics. *TECHNE - Journal of Technology for Architecture and Environment*. Retrieved from doi:10.13128/Techne-15076

means; designing, shaping, forming to the composition of a ‘complexity.’<sup>23</sup> In Germany although the term is used to refer the word ‘design’ in English, its philosophy actually consists the description of ‘the way of designing’ rather than ‘to design.’ In the book ‘Design Dictionary: Perspectives on Design Terminology’ the term ‘Baugestaltung’ is expressed as an act of ‘conscious modification of the visual (aesthetics of objects)’ which conveys the acts of designing each of the sequences of a design process while forming the object’s aesthetic.<sup>24</sup>

In the early twentieth century the theory of Bötticher on ‘tectonics’ was vastly influential in Europe. In the “*Tektonik der Hellenen*” i.e “*Hellenistic tectonic*” he asserts that the essence of an architectural element shapes the representation of it. In Stanford Anderson’s words: “Form gave to the construction material the expression of its fulfillment of function.”<sup>25</sup> Interestingly, one of the architects who was influenced by Bötticher’s thinking was Paul Schmitthenner. In his writings, Schmitthenner asserts that the value of construction comes from its immateriality and expresses the ‘immaterial’ as ‘decoration.’ For him, the word ‘decoration’ does not refer to ‘ornamentation’ but expresses the inherent features of an architectural object: proportions, rhythm, measure, geometry, etc.<sup>26</sup> The established values by Schmitthenner, forms an order of thought, which should be carefully analyzed. Known as not being a fan of the modernist avant-garde, he took the attraction of his era as a traditionalist architect. Schmitthenner, as a vocal critic of the modernists in the late 1920’s, early 1930’s and a committed Nazi, was argued persuasively against by the architectural historian Hartmut Frank, saying:

---

<sup>23</sup> Wikipedia, <https://dictionary.reverso.net/german-english/Gestaltung>  
<https://dictionary.cambridge.org/dictionary/german-english/bau>

<sup>24</sup>Design Dictionary: Perspectives on Design Terminology, Michael Erlhoff, Timothy Marshall,2008

<sup>25</sup>Anderson, Stanford,Peter Behrens and a New Architecture for the Twentieth Century, MIT Press, London, 2000, p.117

<sup>26</sup>Ardito, V. (2014). Baukunst and the project of the construction’s form. Research and didactics. *TECHNE - Journal of Technology for Architecture and Environment*. Retrieved from doi:10.13128/Techne-15076

“Schmitthenner was not really attacked for his Nazi activities but rather because of the extraordinary popularity of traditional and rationalistic, locally oriented architecture that represented in an especially qualified form. This architecture could express itself very well in the context of reserve and modesty necessary during reconstruction.”<sup>27</sup>

As one of the German architects who lived in the early 20<sup>th</sup> century, he is one of the witnesses of the vast demolition of the city fabric. In the conjuncture of his era, he involved and experienced range of reconstruction processes.<sup>28</sup> Because of the increasing number of existing buildings that have been included in the building heritage list after the apocalypse of WW I-II, with (1964) **Venice Charter**, architects pointed the importance of reconsidering not only antique and mediaeval buildings, but also vernacular architecture and industrial buildings. With this expansion, ‘Adaptive Reuse’ emerged as a way to rethinking the old buildings. This situation provided an opportunity for architects to work with historic buildings more often than before.

In Germany there were two highways of thought around the theme of reconstruction of damaged buildings. The first one, retrospective reconstruction, aimed to revive of the image of the old. The second one, ‘ex-novo’, rejects any effort to realize the old. However, the third way ‘interpretative reconstruction’ introduced by Hans Döllgast<sup>29</sup>, opened the way to approach ruins from several perspectives. He proposed that reconstruction followed the characteristic idea of an architect about the connection between past and present. According to Schmitthenner who embraces ‘interpretative reconstruction’, it was essential to understand the aesthetics that

---

<sup>27</sup>Jefrry M. Diefendorf, *In the Wake of War: The Reconstruction of German Cities after World War II*, p.68

<sup>28</sup>Voigt, W., Frank, H., & Deutsches Architektur Museum. (2003). *Paul Schmitthenner 1884-1972*. Tübingen: Ernst Wasmuth Verlag.

<sup>29</sup>La Ricerca nel Politecnico di Bari: Resoconto Generale 2014 - Research at Politecnico di Bari: General Report 2014

emerged from the structural elements of a building. As in the ‘Doric Column’<sup>30</sup> example, a stone is just a stone until it is carved and shaped with both aesthetic and functional concerns.

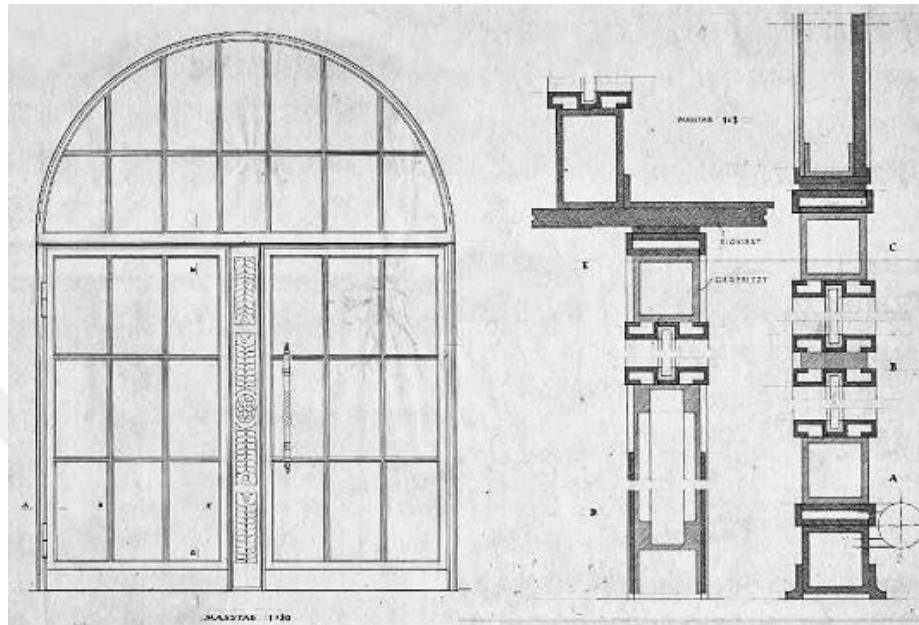

Figure 2.10. Detail Drawing of Schmitthenner from the book ‘*Paul Schmitthenner 1884-1972*’.

In his writings which were discovered in Munich, he outlines the architect’s mission as being aware of the order, dynamic, aesthetics and coherence of each elements of a building like a carpenter so that s/he would construct what is meant for

---

<sup>30</sup>McQuillan, T. (2016). On the Grounds of Modern Architecture: Interview with Kenneth Frampton. *Architectural Histories*, 4(1).



## **2.5. The Old Yapı Kredi Bank**

In this chapter the values of the old YKKS are being investigated on urban, building and detail scales. This investigation will provide a basis in the process of examination of the negotiation constituted within or with the old values of the selected building.

### **2.5.1. Old Values | Urban Scale**

Buildings negotiate with the urban through its elements that is visible on the level of the eye. Therefore, ground levels and facades of the structures play an important role in the negotiation of the building with its surroundings.<sup>32</sup> In the case of the selected building, YKKS, the ground level arcade and the two facades looking onto the street and the square, are accepted as the values on the urban scale.

#### **2.5.1.1. The Arcade**

The character of the ground level of a building generates a ‘baseboard’ which connects the exterior with the interior while also separating them. This part of the building is called the ‘plinth’.<sup>33</sup> Hans Karssenber and Jeroen Laven mention the importance of ‘plinth’:

“A building may be ugly, but with a vibrant plinth, the experience can be positive. The other way around is possible as well: a building can be very beautiful, but if the ground floor is a blind wall, the experience on the street level is hardly positive.”<sup>34</sup>

The plinth as in the case of the old YKKS is the arcade which builds the link between the interior and the exterior; the private and the public, and enclosed and open

---

<sup>32</sup>Matan, A., & Newman, P. (2016). *People cities: The life and legacy of Jan Gehl*. pp.19-29

<sup>33</sup>Karssenber, H. (2016). *The city at eye level: Lessons for street plinths*.p.6

<sup>34</sup>Ibid.p.11

spaces. Arcade as an architectural space, can serve as an example of a transition space, which is a part both of the building and the public at the same time. The reciprocal relation constructed by an arcade, effects the life inside and between the buildings. According to Christopher Alexander “The experience of entering a building influences the way you feel inside the building.”<sup>35</sup> He evaluates the arcade space as the most proper way of creating a ‘realm’ between the building and the public space. Its ambiguous belonging provides a territory which lures the flow of pedestrians inside. Furthermore, according to Jan Gehl, transition spaces created along the buildings’ borders give chance people to stand and experience the surrounding to continue more decisively. He uses a colonnaded space as an example to represent how an attractive transition can be created to allow people stay and watch around while being watched. These experiences originating in the arcade space, affect both the building space and the street/ squarespace positively. Jan Gehl says:

“If the edge works, so does the space.”<sup>36</sup>

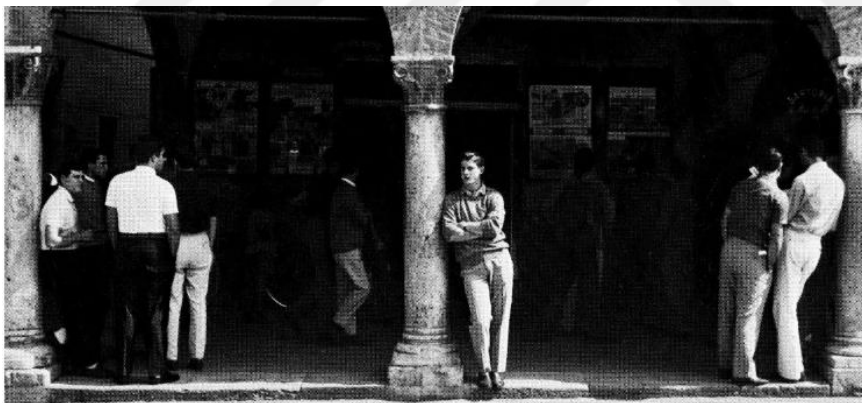

Figure 2.12. The life in arcade space, Places for standing and staying in Ascoli Piceno, Italy, (Gehl, J. (2002). *Life between buildings*. Beijing: China Architecture & Building Press. p.148)

---

<sup>35</sup>Alexander, C., Ishikawa, S., & Silverstein, M. (2010). *A pattern language: Towns, buildings, construction*. New York: Oxford Univ. Pr. pp.549-552

<sup>36</sup>Gehl, J. (2002). *Life between buildings*. Beijing: China Architecture & Building Press. p.151

Thus in reference to the points of Christopher Alexander and Jan Gehl, an arcade can be seen as a very attractive and effective ‘plinth’, a transition between the inside and the outside. With the awareness of the potential the arcade holds, the open colonnaded space of old Yapı Kredi Building should be examined in further detail.

The open arcade can be considered as one of the old values which develops a different way of connection apart from other buildings along İstiklal street. In 19<sup>th</sup> century, the street was full of neoclassical elements which composed the vertical texture of İstiklal, creating an attractive eye-level experience. The classical architectural elements such as niches, pilasters, projected windows and eaves were creating positive volumes in the street. Differently from these architectural elements, the open portico with its negative volume, can be seen as one of the first attempts which is empowering the three dimensionality of the street by adding a void rather than a projection.



Figure 2.13. Street view from İstiklal street showing the projections of the facades, digital drawing on photograph from Teget's Archive Street view from İstiklal street showing the projections of the facades, digital drawing on photograph from Teget's Archive.

Generally, the arcade surrounding the retail functions, allows entry to indoor spaces with more than one doorways. However, because the building was designed as the headquarter of the Yapı Kredi Bank there was only one entrance from the İstiklal street to the building. Having only one entrance to the building through the arcade, reduces the flow in between the building and the city. The lack of passage on the side of arcade facing towards the Yeniçarşı street makes this space a part of the street rather than a transition space.

It is important to realize and remember the fact that the arcade space was initially facing a refuge rather than a relatively enough squarespace with a sculpture in its center. Until 1990's, no perception of a square did exist. The first reason was the corner buildings which was firstly a police station, then a health center on İstiklal Street, on the corner of Galatasaray high school. The second reason was that İstiklal was not yet pedestrianized. There was a refuge to allow for two-way vehicle traffic, which divided the space into three segments.

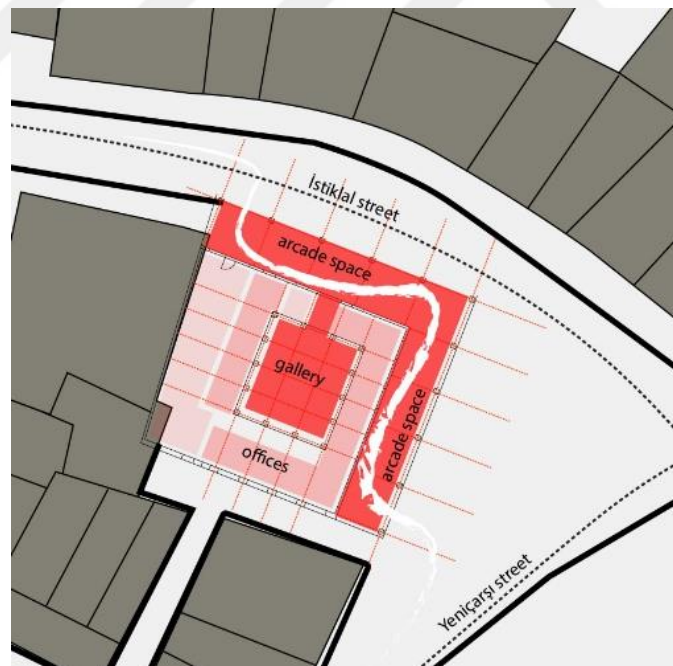

Figure 2.14. The pedestrian flow in the arcade space of the old YKKS designed by Schmitthenner.

With the pedestrianization of İstiklal street in 1990<sup>37</sup>, the refuge was removed and traffic bullets were placed to limit vehicle flow. In addition, one of the sculptures of Şadi Çalık, was installed as a memorial of the 50<sup>th</sup> anniversary of the Turkish Republic.

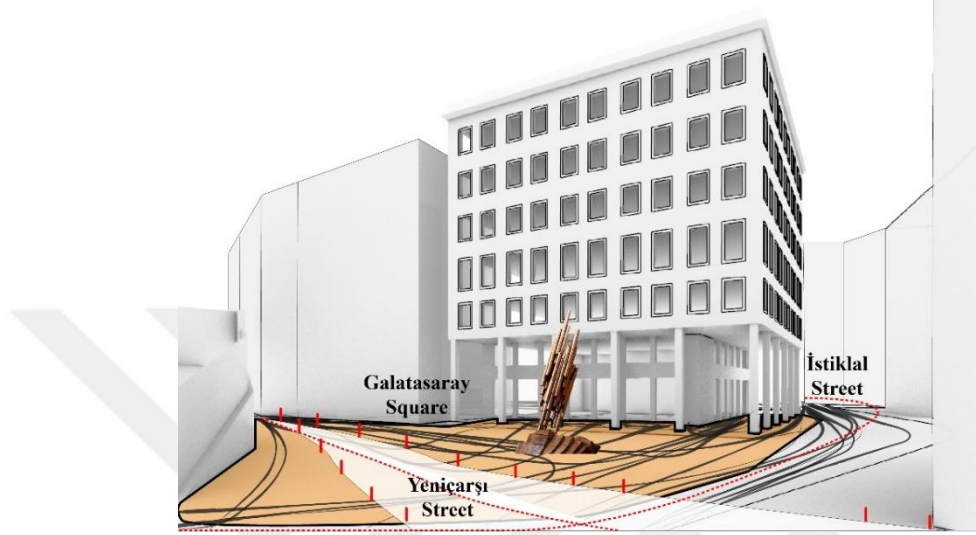

Figure 2.15. The collage work illustrates the conditions with the removed refuge and emplaced Çalık's sculpture together with the traffic bullets.

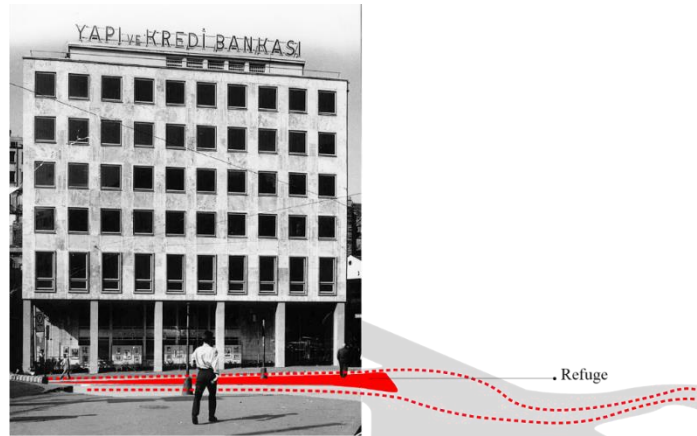

Figure 2.16. Photo diagram showing the traffic refuge.

<sup>37</sup>Thys-Şenocak, L. (2011). İstanbul 1910–2010 Kent, Yapılı Çevre ve Mimarlık Kültürü Sergisi City, Built Environment and Architectural Culture Exhibition. Journal of the Society of Architectural Historians, 70(3), pp.379-381.

The collage below, which brings together the sculpture and the arcade space of the building along the borders of the triangular square, demonstrates that, if Schmitthenner's arcade was not enclosed, the square space would have hosted various activities as a public square.



Figure 2.17. The collage image showing a possible daily life in front of the arcade space of the old Yapı Kredi Bank

Thus it is possible to assert that, the buildings' plinths not only create the borders shaping the architectural space but they also construct the outdoor spaces according to where and how they are defined.

#### **2.5.1.2. The Old Corner Facades**

The architect Schmitthenner's ideas on structure and aesthetics which he called 'Baugestaltung' affected also his design of his façades. His effort to construct a sense of order by means of the structural pattern can also be traced in the Yapı Kredi Bank building. Although, he considers the clarity and regularity of the elements in reference to the structural order underlying the façade, in the Yapı Kredi Building's façade drawings, the geometrical composition is supported by classical elements like pediments and cornices.

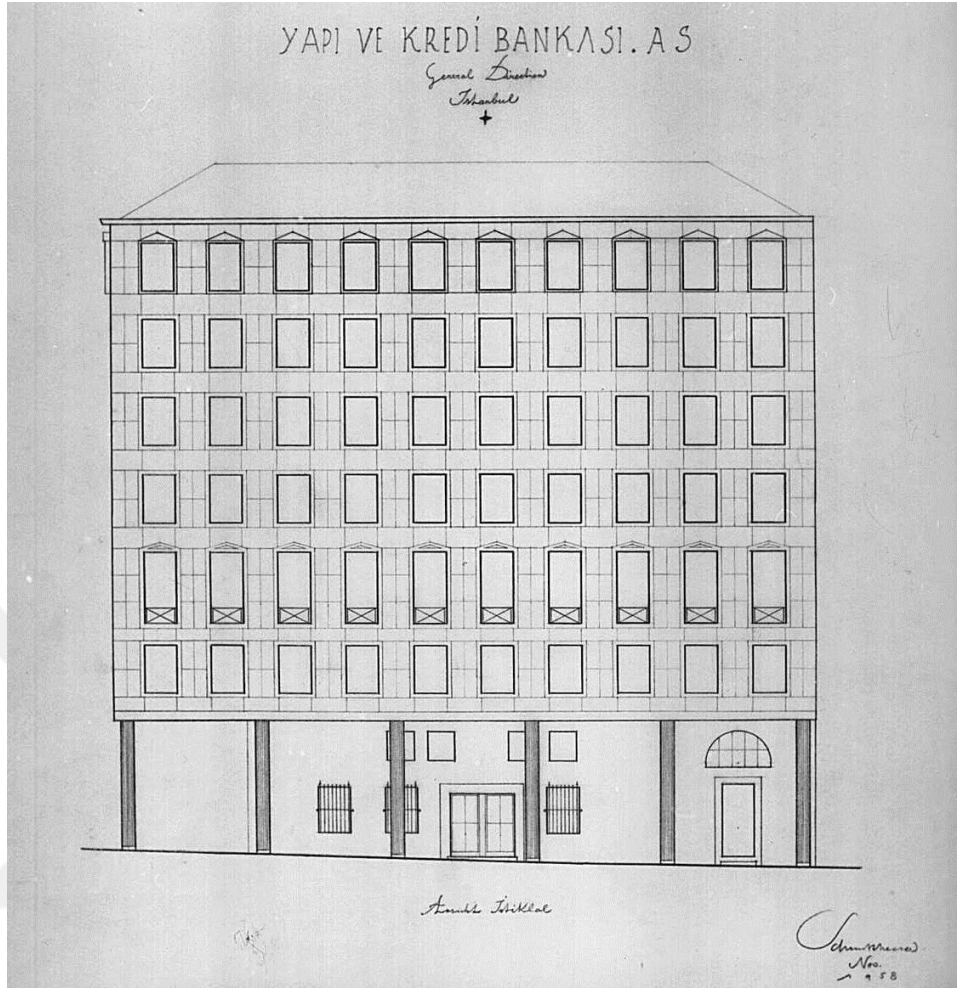

Figure 2.18. The North-West façade drawing by Schmitthenner, Teğet Archives

It is interesting to prefer classical elements on the façade for such an architect who claims the decoration is the result of an order constituted with architectural tectonics. Therefore, the reason to choose such classical additions can be his sensitivity on historical values apart from his principles on “Baugelstaltung”.



Figure 2.19. The North-West façade drawing by Schmitthenner, Teget Archives



Figure 2.20. The North-West façade analysis-digital drawing in reference to the Schmitthenner' hand drawings.

The analysis above shows the main geometries of the classical elements of the former Levantine building's north-east façade. Regarding the old order, it can be said that the essence of classical elements on the drawings of Schmitthenner comes from the former building's values. He evaluated the old values and simplified their representations by means of his way of using the selected cladding material -travertine which will be mentioned in the scale of detail.

The rows indicated by the letters are used to understand the set of order of the façade more clearly. Row 'a' with the repeated rectangular window geometry shows a dominance in the overall image of the façade. Therefore, it somehow generates a background for the rows 'c', 'b' and 'x'. The windows with triangular pediments in row 'c' and balcony projections of row 'b' give references to the historical Levantine building. On the other hand, in row 'x', the asymmetrical order that the architect preferred, reduces the strict symmetry of the façade. Another significant element drawn yet not applied on the construction is the pitched roof which is probably referenced to its predecessor. Because there is no document, save Ara Güler's photograph, that shows a limited portion of the old apartment building, it is not possible to make a comparison. However, it can be said that with the pitched roof Schmitthenner aimed for the continuation of the roof lines of the building along the axis of İstiklal street.

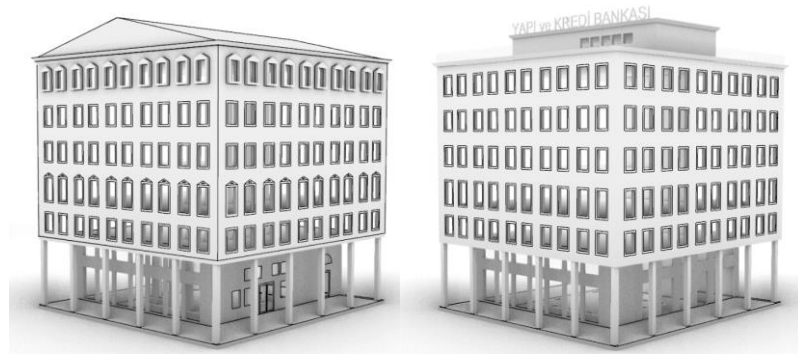

Figure 2.21. On the left: the model made according to the drawings and on the right: the model of the constructed building of Yapı Kredi Bank.

The images with both models are to showcase the changing character of the constituted images in reference to drawings and to the actual constructed building. The disappearing classical elements on the second and the fifth floors, omitted order of windows and doors at the entrance on the north-west façade and the pitched roof that was replaced resulted in a different construct for street and square facades. Thus, it can be deduced that the subtle sensitivity of Schmitthenner for the history of the building and its context was lost in the process of construction of the building.

### **2.5.2. Old Values | Building Scale**

In this part of the study, the building will be studied as an architectural object. According to Schmitthenner's principle as to what makes an architectural object functional, beautiful and meaningful at the same time is its structural order and the composition of the spaces in reference to its structure. Pierre von Meiss defines three strategies for spatial composition in his book '*Elements of Architecture*.' For him these three approaches are: the space of the structure, the Raumplan and the free plan.<sup>38</sup> According to the Meiss' classification, the Schmitthenner's design approach can be seen as 'Structure-space' which constructs "a rigorous agreement between the order of the loadbearing structure and the figure of space captured thus."<sup>39</sup> Regarding Schmitthenner's design principles and Meiss' definition of structure-space, the old Yapı Kredi Building's structural order and figure of space thus captured are accepted as values on the building scale.

#### **2.5.2.1. Structural Order**

The cubic geometrical volume of the building includes three structural orders in sequence through the core of the structure. First is the peripheral structural columns which surrounds the arcade space while generating the reference axes for the façade openings. The second is the load bearing walls that draw the borders of the enclosed

---

<sup>38</sup>Von, M. P. (2014). *Elements of architecture: From form to place*. Routledge. p.154

<sup>39</sup>Ibid. p.155

space of the building and the third is the structural columns defining the gallery space. The structural order divides the building space into three segments both on the ground level and on the upper floor levels. As seen from the ground level plan of the building these spaces are in sequence: the arcade space, the offices with the service functions (stairs, toilets, storage rooms) and the gallery space at the center.

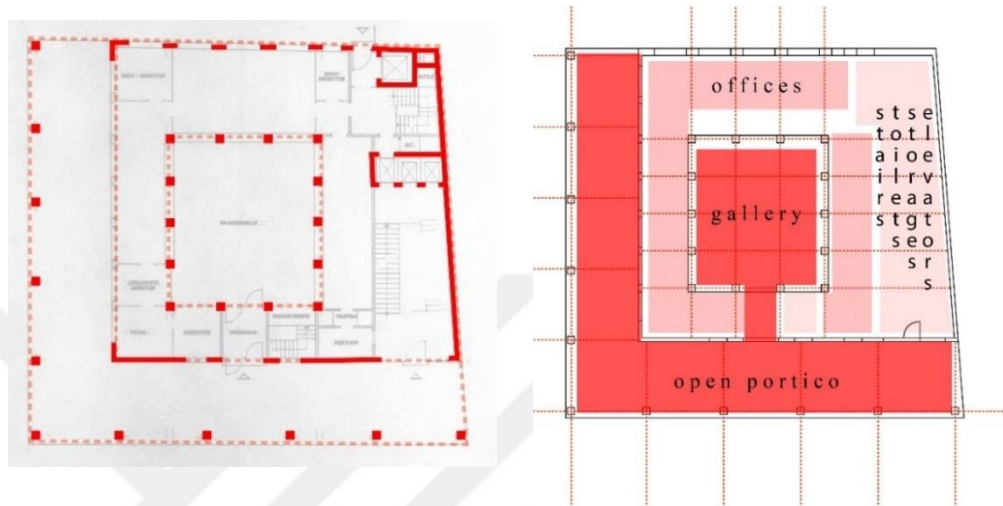

Figure 2.22. On the left: structural orders and on the right: the space division at the ground level by means of the structural elements are illustrated.

### 2.5.2.2. Structural Space

The structural order of the building produces three almost-square-shaped regions which are both drawn back equally from İstiklal street and today's Galatasaray square. This directional regression of the load bearing systems generates concentric spaces where one could experience spaces contained and containing at the same time. The gallery and the arcade spaces create vertical voids, which change the floor outlines on the ground and first floors. Thus, city and building spaces that are interwoven can only be experienced on these levels. In view that the floor is the less transformable element in the structure, it can be deduced that the decisions on the outlines of the floors of the buildings hint on the future character of these spaces.<sup>40</sup> In the case of the old Yapı Kredi Building, it can be said that except for the first two, the horizontal fragments of the building's spaces are not designed with the same concerns. Therefore,

<sup>40</sup>Ibid. p.164

it can be deduced that despite the attempts to broaden the experienced limits of the interior space on the ground floor, the architect Schmitthenner did not further the same character on upper floors, purposefully.

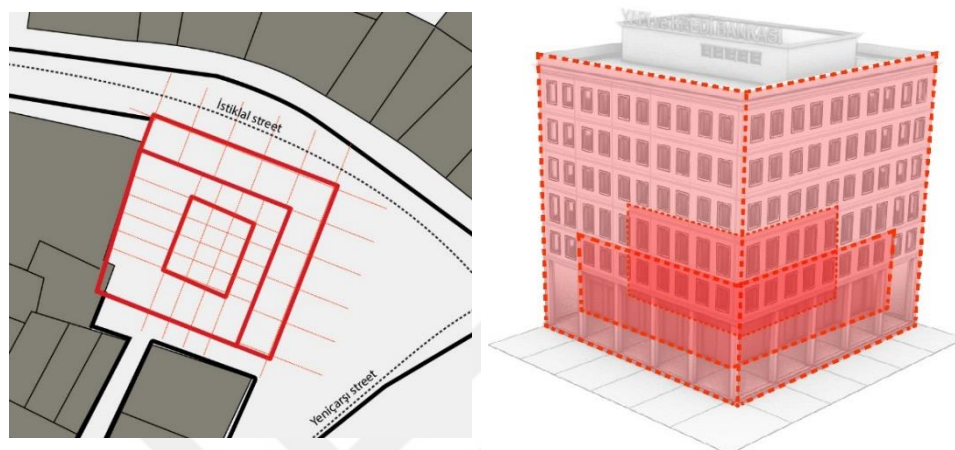

Figure 2.23. The concentric space relations of the building are shown with the plan and three-dimensional model.

### 2.5.3. Old Values | Detail Scale

Edward Ford in *The Architectural Detail* states that:

“Details are not a class of objects, a library of symbols or a collection of clever devices. They are the evidence of a necessary mediation between the way in which we see a building and the way we feel a building, between abstraction and animation, between material reality and idealized forma, an impossible to quantify informing of one set of attitudes with the other.”<sup>41</sup>

According to Ford, details of a building are the very first representatives of the relation constructed between the materiality of tectonics and form. Thus they can be seen as “minimal units of signification in the architectural production of meaning.”<sup>42</sup> As an architect who values order, dynamics, aesthetics and coherence of each element

---

<sup>41</sup>Ford, E. R. (2013). *The architectural detail*. New York, NY: Princeton Architectural Press.

<sup>42</sup>Deely, John N. (2012). *Semiotics 1981*. Springer Verlag. p.325

of a building in the construction of the final whole, details designed by Schmitthenner are critical for the architectural design of his buildings. Vitangelo Ardito evaluates his unique way of designing the details:

“This insistence on studying every detail of the wall, because nothing is insignificant, but in a balanced way, in order to bring together all the parts using discreet connective elements that are indicative of a desire to keep the ornamentation simple and ‘domestic,’ is Schmitthener’s trademark.”<sup>43</sup>

With the aim to examine the concerns for a subtle design underlying the details of the old Yapı Kredi Building, the façade and plan drawings found together with the building’s photograph by Ara Güler is used to spot the important details which should be investigated further. In the scale of detail, the windows on the preserved facades, the columns surrounding the lodge space and the cladding material i.e. travertine are reminiscent of the old values. Because there is not a single detailed drawing of the old Yapı Kredi Building, one must look for these details and examine them.

#### **2.5.3.1. Windows**

A window as an architectural element is essential for a building for light and ventilation. Apart from these fundamental qualities it provides, it defines the relation between the interior and the exterior worlds. The spatial boundaries and the details of a window determines the story of the interior for an onlooker from the outside and of the exterior for an interior observer. According to Till Boettger, the way an opening “locks, obstructs, invites, extends or limits, determines the spatial experience.”<sup>44</sup> From Schmitthenner’s drawings, it can be seen that despite the technological advance of his era, he preferred to use structural constraints in the openings of the façade. He used mostly the rectangular shape windows to provide a view through outside.

---

<sup>43</sup>Ardito, V., & Schmitthenner, P. (2014). *Paul Schmitthenner, 1884-1972*. p.193

<sup>44</sup>Boettger, T. (2014). *Threshold Spaces: Transitions in architecture analysis and design tools*. Basel, Switzerland: Birkhäuser.

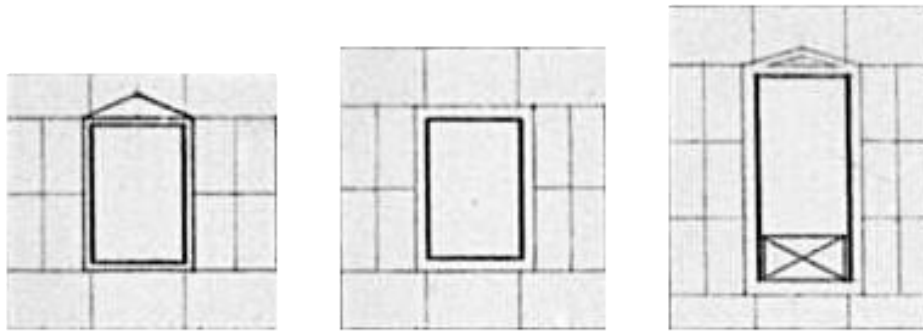

Figure 2.24. Schmitthenner’s partial façade drawing showing the rectangular windows designed for the old Yapı Kredi Bank building, Teğet Archives

The geometry of a window frame was discussed by Auguste Perret and Le Corbusier in the early 20<sup>th</sup> century. For Perret, the best way to frame a view is possible with a portrait rectangular window which is “capable of framing a man and taking everything necessary at each level- some sky, some garden, some pavement – and no more than that.”<sup>45</sup> On the other hand, Le Corbusier recommended a portrait rectangular – ribbon- window which allows for a panorama view.



Figure 2.25. Representation of portrait rectangular by Perret window and ribbon window by Corbusier.

<sup>45</sup>Davis, B., Koolhaas, R., Trüby, S., Westcott, J., Harvard University (Cambridge, Mass.), & International Architectural Exhibition. (2014). *Elements of architecture*. ‘Ribbon vs. Portrait’, Venice: Marsilio. p.650

However, it is important to understand that displayed view changes according to the position of the observer. Therefore, while Perret's ideal geometry invites to view the outdoor from a closer viewpoint, Corbusier's portrait rectangle window necessities a distance between the viewer and the window to watch the framed view. The openings of the old Yapı Kredi Building can be considered as the 'portrait rectangular windows' which requires that the outside is viewed from a closer viewpoint. Thus the outside image is perceived separately from the inside view. That is why, for an interior observer, there is no superimposition of the inside and outside views.

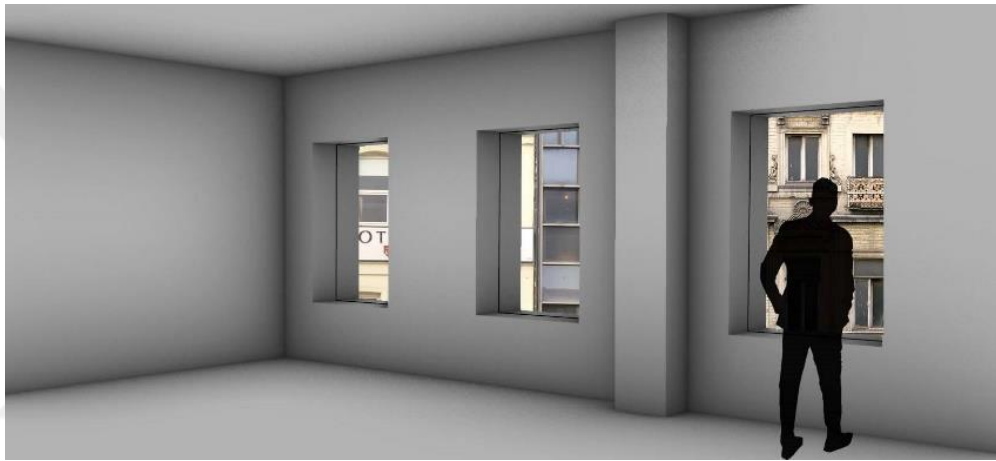

Figure 2.26. A render composition showing the interior viewpoint of the old Yapı Kredi Bank's rectangular windows.

### **2.5.3.2. Arcade Columns**

The columns as the main elements of the arcade space have the most important role to represent the character of this space. Therefore, their; order, material and fragments can be seen as the elements containing some clues about the design idea of the arcade space. In the façade and the plan drawings of the Yapı Kredi building, the arcade columns are represented as circular columns with flutes and bases. However, in the photo taken after the construction of the building, it is seen that they are transformed into square shape columns cladding with travertine.

The set of order of the columns give references to the façade composition, thus the spatial configuration of the interior space. Therefore, it is possible to say that Schmitthenner uses structural elements not only as the structure itself but also as the markers of the organization of the building plan.

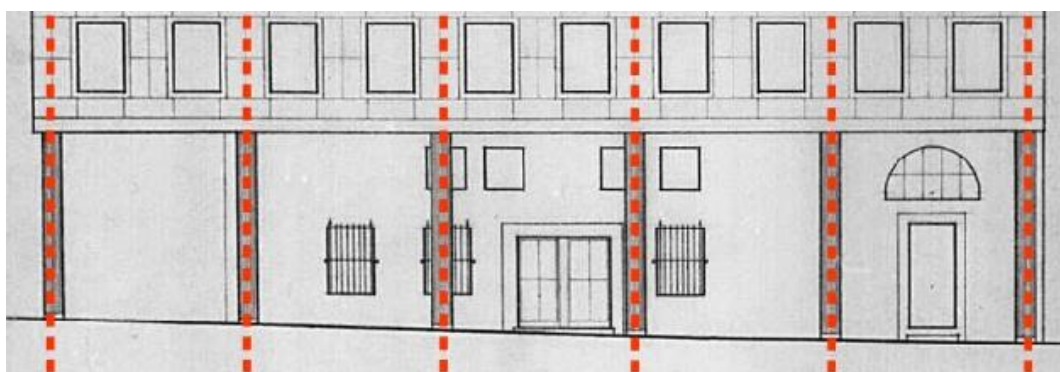

Figure 2.27. Circular Arcade columns' drawn by Schmitthenner, a part of Schmitthenner's plan and façade drawing, from Teĝet Archive.

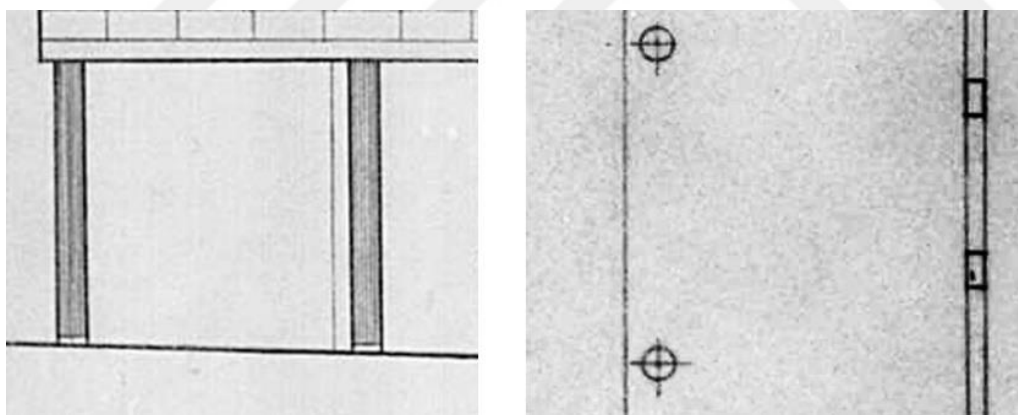

Figure 2.28. Arcade columns' reference axes for the old façade, Schmitthenner's drawing from Teĝet Archive.

### 2.5.3.3. Cladding

The concept of cladding was first foregrounded by Gottfried Semper and further elaborated and expanded by Adolf Loos in the period marked by increased technological advancements. Semper interpreted ‘cladding’ as the symbolic representation of a construction. He associated the words ‘Gewand’ (dress) and ‘Wand’ (wall).<sup>46</sup> Hence, his construction of the theory of cladding (Bekleidungstheorie) in the pursuit of aesthetics of dressing. After Semper, Loos evaluated the purpose of cladding in a somewhat performative rather than figurative sense, in an era where new materials and construction techniques blossomed.<sup>47</sup>

“For Adolf Loos cladding both encloses and finishes.”<sup>48</sup> He asserted that as it is the cladding which makes a space livable, then it cannot be thought as a face or a mask only, which neglects the spatial character of an enclosure or the way a building is built. Regarding Semper’s and Loos’s ideas on cladding, a more comprehensive interpretation is also possible in the case of the old Yapı Kredi Building. In Schmitthenner’s drawings of the Old Yapı Kredi Building, only the properties and order of the exterior cladding material can be seen. Therefore, it will be mainly the exterior cladding character that this part of the study shall focus on. The old façade of Yapı Kredi Building represents a strict order not only with its openings which take their reference from the underlying structural elements but also with the composition of its cladding. The order of travertine plates draws borders between the interior space from the outside. The vertical travertine plates represent the interior arrangement with its repeating order that equally divides the distance between the windows. In addition to that, the floor levels were also highlighted with horizontal travertine plates, which

---

<sup>46</sup>Von, M. P. (2014). *Elements of architecture: From form to place*. Routledge. p.314

<sup>47</sup>Panin, T. (2009). *Architectural spatiality: The dialectic between the concepts of Raum and Bekleidung*. Saarbrücken, Germany: VDM Verlag Dr. Müller.

<sup>48</sup>Panin, T. (2007). On The Surface: Purposes of Architectural Enclosure. *NAJUA: Architecture, Design and Built Environment*, 22, p.28

take the references of its borders from the opening frames. The use of rationalist order provides for the constitution of a more classic and serious image that symbolizes the building's institutional character. It can be deduced that both the image of cladding and the structural order underneath were critical considerations for Schmitthenner.



Figure 2.29. Drawing inverted to highlight the order or the Travertine plates on the façade of the old Yapı Kredi Building.

## CHAPTER 3

### **‘FINE LINE’ CHARACTER OF THE YKKS BUILDING**

As mentioned before, architecture of the new YKKS building “negotiates a fine line between transformation and preservation.”<sup>49</sup> This study seeks to understand this ‘fine line’ character with a creative vocabulary constructed on the bedrock of the term ‘Tangent.’ In line with this purpose, this study employs such elements of this vocabulary as the ‘inherent duality’, ‘reducing distance’ and ‘extremity,’ as tools to examine the ‘fine line’ character. So far, the quality of ‘inherent duality’ directed the study to examine the old values in detail in view to define new ones. The examination of older values modeled the distance reducing quality of the term ‘tangent’ and hence the analysis of old values under the three scales starting from the urban scale to the building and to the scale of detail. In this chapter the main purpose is to investigate the extremities between the old and the new values and understand the design idea behind it and thus, to know about the ‘fine line’ character of the building’s architecture. In this regard, the negotiation between the old and the new values will be questioned also by using the distance reducing quality of ‘Tangent.’ At every scale the question: ‘whether or not the negotiation between the old and the new values can be interpreted as a successful togetherness?’ will be asked in view of these extremities.

#### **3.1. Urban Scale**

From the urban scale, old values are identified as the arcade and the facades of the building for they are the only parts which are visible from the eye level of a pedestrian. Regarding the Schmitthenner’s arcade and facade design, in this part of

---

<sup>49</sup>Kafka, G. (2017, December). Opening Statement of the AR New into Old Awards. *The Architectural Review*, 1447, p.10

the study the evaluations of the arcade and the facades will be studied through the extremities developed on older values.

It is exciting that the sketches of Kütükçüoğlu starts from the city scale and continue with the building's eye level perspective and following them, at the end of the same paper, culminates in an organization sketch of the interior space. From this drawing organization, it is possible to see the designer's flow of thought on the YKKS building. Interestingly, the first idea seems to have emerged in the urban scale. The lines representing the position of a person on İstiklal street indicates the eye level experience that Teğet Architects consider. The continuous interaction between the pedestrian, the square and the building aspired for comes from the interpretation of the old arcade.

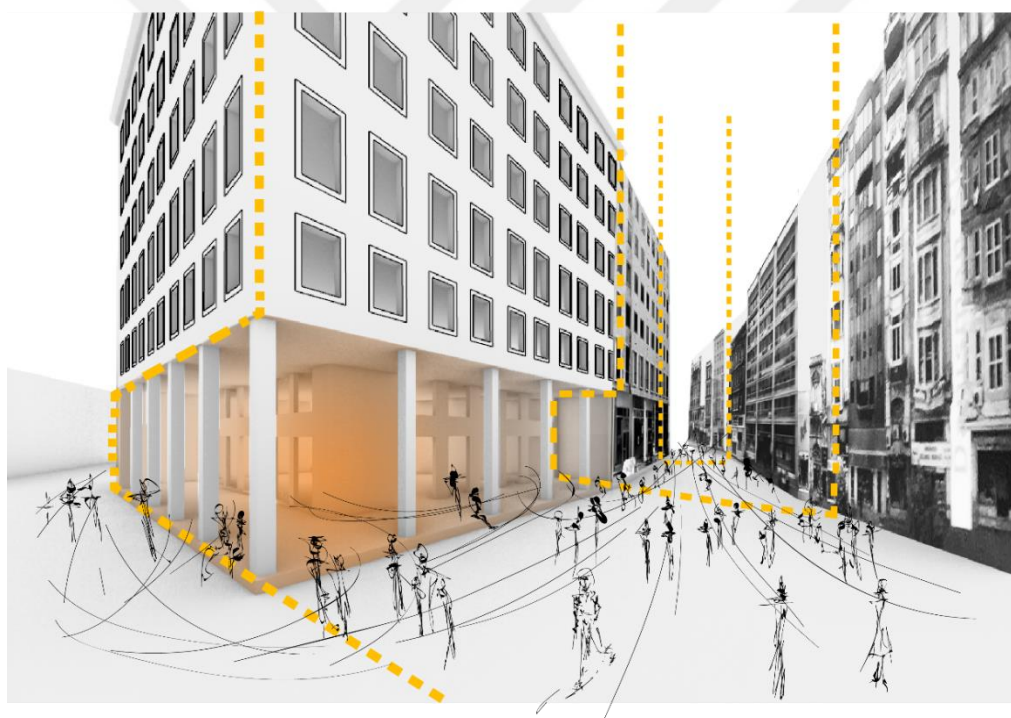

Figure 3.1. The arcade design of Schmitthenner, which generates an unusual void in the narrowness of İstiklal street.

According to Teğet, the most important character that distinguishes Schmitthenner's building from its surrounding background was the arcade which continues through the corner of the building. As mentioned before, the reason can be

the unusual void of the arcade where people can set back in the narrowness of the street. Teğet finds this narrowness as a value for İstiklal and therefore interprets it as a canyon-like street, which offers an attractive experience on the ground floor-level while reducing the vertical experience to a minimum. For this reason, looking at the first sketches of Kütükçüoğlu, it can be said that, the essence of the void which wants to be carried out into the building's verticality comes from the arcade of the Schmitthenner's Building.

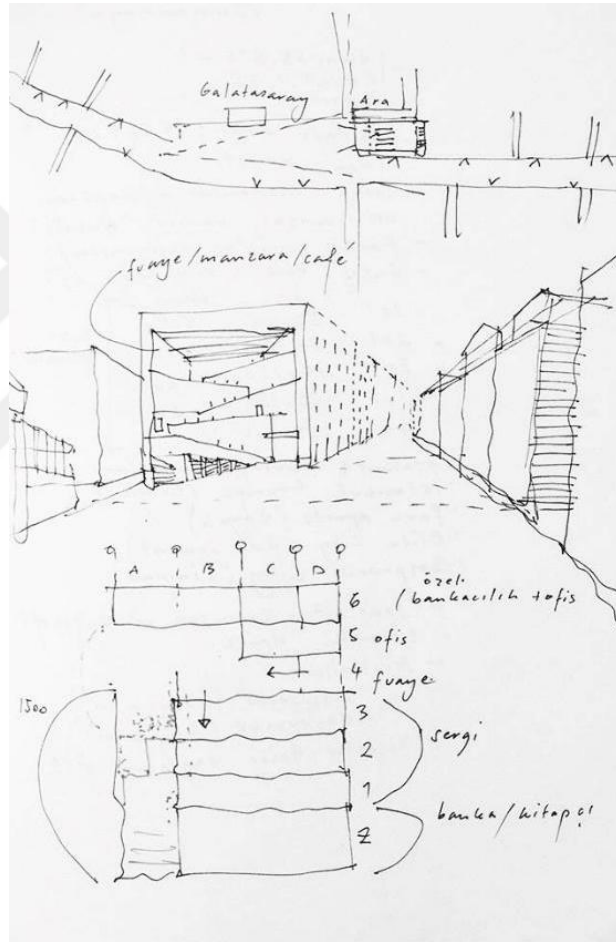

Figure 3.2. The first sketches of Mehmet Kütükçüoğlu showing how the design idea developed, courtesy of Teğet Archives

Teget elevated the arcade void into the building's space.<sup>50</sup> Thus, the street has found the chance to be experienced and to be watched from this vertical angle. It can be said that, the old plinth idea has changed in the square-facing façade, while the colonnaded transition space-quality of the street façade has been preserved. The effort to shape the communication between the exteriors and the interiors of the building demonstrates the importance of a definition of the interaction between the two realms for Teget Architects. Zumthor mentions the importance of the intersections in various forms and functions in his book 'Thinking Architecture.'<sup>51</sup> As he emphasizes, these intersections are so important to understand that they inherit the basic design-idea of a building. In this respect, it can be deduced that how Teget considers the connection or interface of the building with its surroundings, i.e. the city, is one of the main ideas from which the building's architecture has emerged.

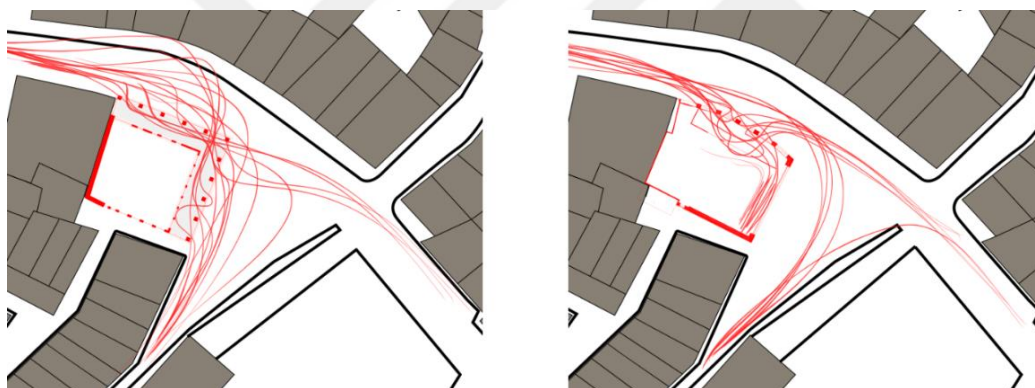

Figure 3.3. On the left; the pedestrian flow diagram of Schmitthenner's arcade and on the right; the pedestrian flow of 'vertical promenade.'

In order to see how the transformed relation works through the building's edge, there is a need to look into the flow diagrams of both the old and the new conditions. As seen in fig.3.3, Schmitthenner's arcade relates mostly with the street than the

---

<sup>50</sup> Teget Architects, (2017), YKKS – Yapı Kredi Art and Culture. Retrieved from <https://www.teget.com/works/ykks/>

<sup>51</sup> Zumthor, P., Oberli-Turner, M., & Schelbert, C. (January 01, 2006). Thinking architecture.

building. It can be said that it acts as a transition between the street and the square rather than between the interior and the exterior spaces of the building. On the other hand, in case of the new YKKS, this relation extends into the interior space but does not allow immediate outside access.

The flow diagrams show that even though the transparent façade looking onto the square draws a border which delineates the physical transition towards the outside, the flow of movement is preserved at the square facing side of the building. Differently from the old arcade, the rising promenade constructs a direct relation with the interior while demonstrating this relation for the outside. There is no more a plinth to mention but a space which is only meaningful as a whole, as the façade, for example, that needs to be perceived from a proper distance.

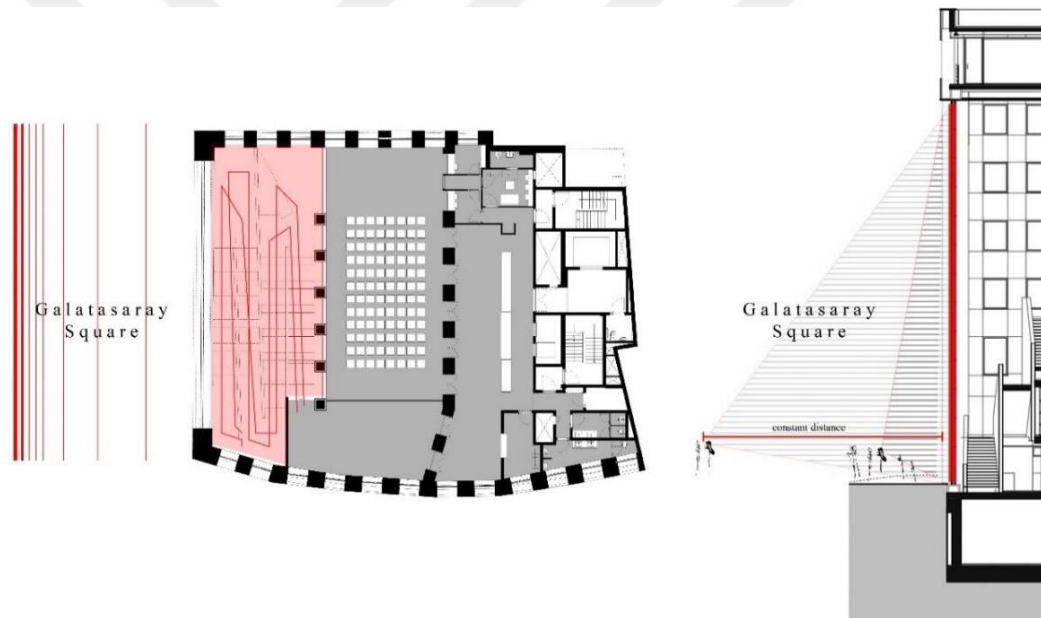

Figure 3.4. The flow of movement limited in the vertical promenade and the proper distance for the visual perception of the interior space indicated both on the plan and section drawings of YKKS.

Understanding what makes this interior volume visible is important to see how the old value is appreciated within the new values. It can be said that, firstly, it is the fully transparent curtain wall and then, the organization of the interior volume which sets back gradually while rising. As Colin Rowe, Robert Slutzky and Bernhard Hoesli asserts in the book 'Transparency,' the idea of transparency is not only reduced to a

mere material quality-condition of opaqueness of a curtain wall, but it represents a phenomenal meaning which is about spatial ordering.<sup>52</sup> In this regard, in the case of YKKS, transparency both as the quality of the material and as the quality of spatial organization can be accepted as a new value which reflects the essence of the old arcade in the depths of the vertical promenade which extends its limits through its transparent composition.

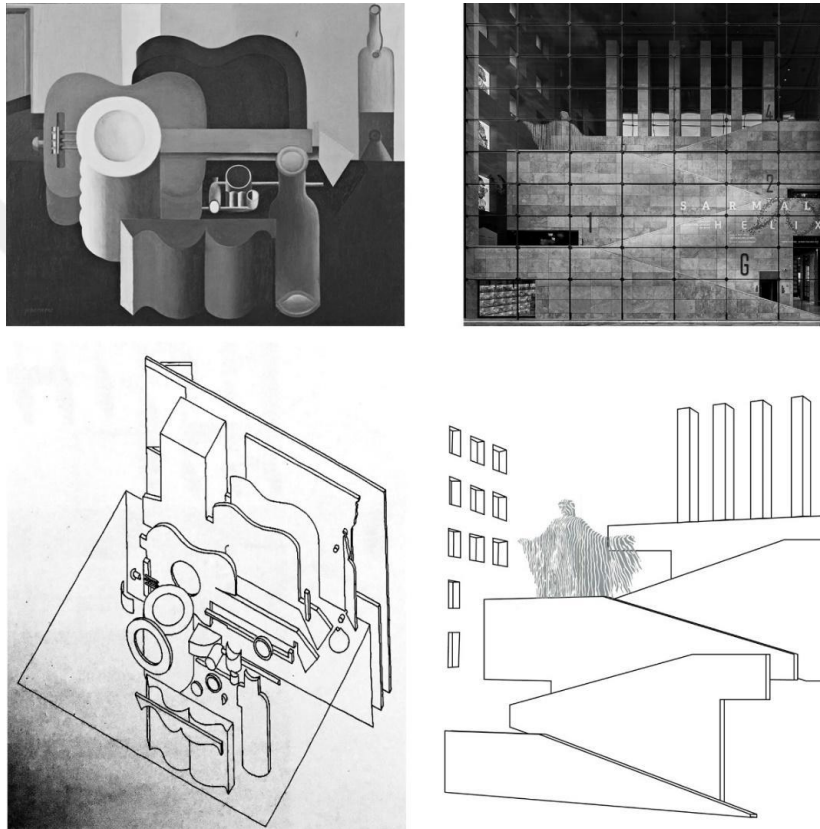

Figure 3.5. Transparent quality or the quality of the transparency of the spatial organization of the YKKS in reference to the spatial a painting by Le Corbusier. (Bernhard Hoesli in “Kommentar und Addendum”).

<sup>52</sup>Rowe, C., Slutzky, R. (1963), Transparency: Literal and Phenomenal, first published in Yale Architectural Journal Perspecta, Vol. 8, Reprinted as Transparency, Hoesli, Bernard (1968), Basel: editions Birkhaser, p.160

The way the façade merges the elements of the building to create the sense of depth is similar to how Le Corbusier ‘Guitar Dodo’ brings together the layers of a painting. In both cases the compositions “tell us that an object partially hiding another must be in front of it.”<sup>53</sup>

In contrast with the transformation of the square-facing façade, on the street-facing side; the ground level relation of the building and the façade organization directly preserves the old values. With the arcade reopened, the ground level plinth is regenerated. However, despite the arcade together with the old façade organization represents the old image of the YKKS building without any dramatic interpretations, their functional relations have totally changed. The new colonnaded transition space works as an entering portico which attracts people to slow down and stand for a reason and continue without entering the building. In this perspective, it can be said that, although Teğet claims that the old arcade is reopened and the old value is regenerated, the space does not function as it used to. Thus, for the street facing façade of the building, it can be said that the old inhabits new values.

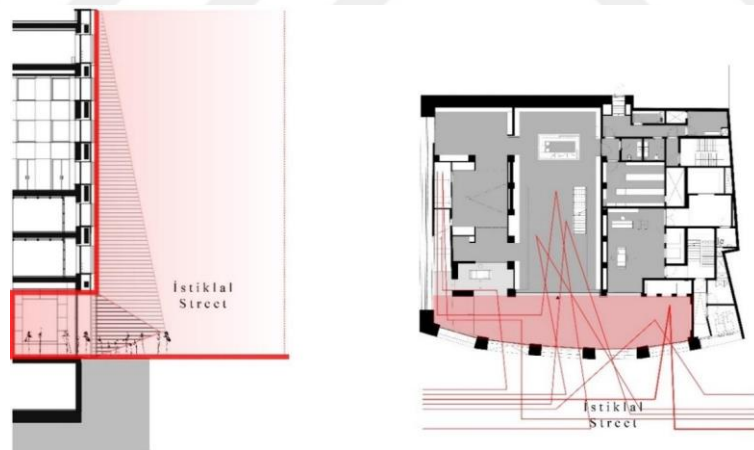

Figure 3.6. The section illustrates the spatial relation of the ground level with street and the plan represents the movement flow between the street and the building.

---

<sup>53</sup>Von, M. P. (2014). *Elements of architecture: From form to place*. Routledge.p.164

In reference to the analysis of the arcade and the facades of the building, it is possible to interpret that there are two contrasting evaluations of the old on the street and square sides. While the square-facing façade is totally transformed figuratively and functionally, still it preserves its purpose. It allows people to stand and spend time in an intermediate space which belongs neither to the outside nor the inside. On the other hand, the street-facing façade preserves the image of the old façade organization of Schmitthenner together with the arcade elevation while transforming its function entirely.

The past, for Rodolfo Machado is material to be altered and reshaped for a new opportunity.<sup>54</sup> In connection with Machado's view, one can interpret that, in the building or urban scale, both the transformed façade representing a totally new value and the preserved façade, which stands for the well-kept old values, are alterations and a reshaping of the old despite all contrast between the old and the new.

### **3.2. Building Scale**

As discussed by Teğet Architects, some architectural values are preserved in order not to lose the collective memory of a very important public space and also, not to demolish well thought architectural quality. In this regard, Teğet preserved the structural order of the old building and strengthened it by means of additional structural systems. New spatial relations are designed in the same structural grid. Thus, the resulting structural order and the spatial conceptions negotiate directly with the old structural grid and space quality. As for the old Yapı Kredi building, the structural order and the structural space of the new YKKS can be construed as extremities that foster ambiguous relations between old and new values and therefore need to be studied in detail.

---

<sup>54</sup>Machado, R. (1976). Old buildings as palimpsest. Towards a theory of remodeling. *Progressive architecture*, 11, pp.46-49.

In order to be able to discern how Teğet uses the existing structural order while configuring a new space, there is a need for superposition of the existing structural elements with the way the new plan has been organized. In the image, green color represents the elements that are preserved and red, the ones to be removed. The elimination of the square-facing façade mostly expressed as an act of “opening the building like a box”.<sup>55</sup> However, it is actually not only about the façade that has been removed but mainly about the structural elements of the old building which are found to be removed.



Figure 3.7. The superimposition of the old Yapı Kredi Bank's and YKKS building's structures.

Designing the void of the space by removing the existing values is not a new method in the creation of an architectural space. In ancient Greek, in the words of Francesco Cacciato, “the term stereotomic, from the Greek *stereos* (solid) and *tomia* (cut), introduces an idea of building, which is not conceived as the assemblage and juxtaposition of elements typical of the tectonic approach, but rather as the gradual

<sup>55</sup>Kütükçüoğlu, B. Bugatti, E. (2019, April), ‘*An Opening to the City*’, Yapı Kredi Publications, p.81

removal of matter from an initial shape.”<sup>56</sup> Based on this explanation; “the application of the stereotomic approach to architecture results in the generation of monolithic and compact forms, where the individual parts cannot be discerned from the whole and in which the removal of matter produces the intended architectural spaces.”<sup>57</sup> A parallel can be drawn between the stereotomic approach and the Težet’s treatment of the old the structure. As regards this claim, it can be said that the new value of the architectural space is created from the old or from within the old one.

Structural elements can be considered as the solid aspects, which define the building space. Solid aspects create limitations in the design of the architectural space. Following this assertion, any intervention of Težet Architects to the structural elements can be evaluated as the direct manipulation of the structural space. Raimund Fein describes the space as “the void defined by what fills it, or surrounds it”<sup>58</sup>

In the case of YKKS, Težet decisions regarding what shall surround such space generated a new volume. Despite the removal of some structural elements, the structural grid was intact. Therefore, even if the spatial organization transformed with new separations and openings, the main hierarchy is preserved. The old building’s central gallery gave spatial reference for those places where the main functions take place mostly in double or triple height. On the ground floor, the bookshop; on the second floor the exhibition hall; and on the fourth floor the lodge-space take reference from the axes, the space quality and the transparency of the old gallery. Each of them offers not only multiple visual interactions within its own void but also within the void(s) that surrounds it.

---

<sup>56</sup>Evans., R., *The Projective Cast: Architecture and its three geometries*. MIT Press, 2000.

<sup>57</sup>Cacciatore, F., *The wall as living place. Hollow structural forms in Louis Kahn's work*. Lettera Ventidue, 2011.

<sup>58</sup>Fein R., *Design by Theory*, [in:] *Definiowanie przestrzeni architektonicznej. Projektowanie architektury a teoria*. Kraków 2002. p. 24; [also:] *Project Troll in Competition for Center of Art and Theatre in Sundsvall in 2008*

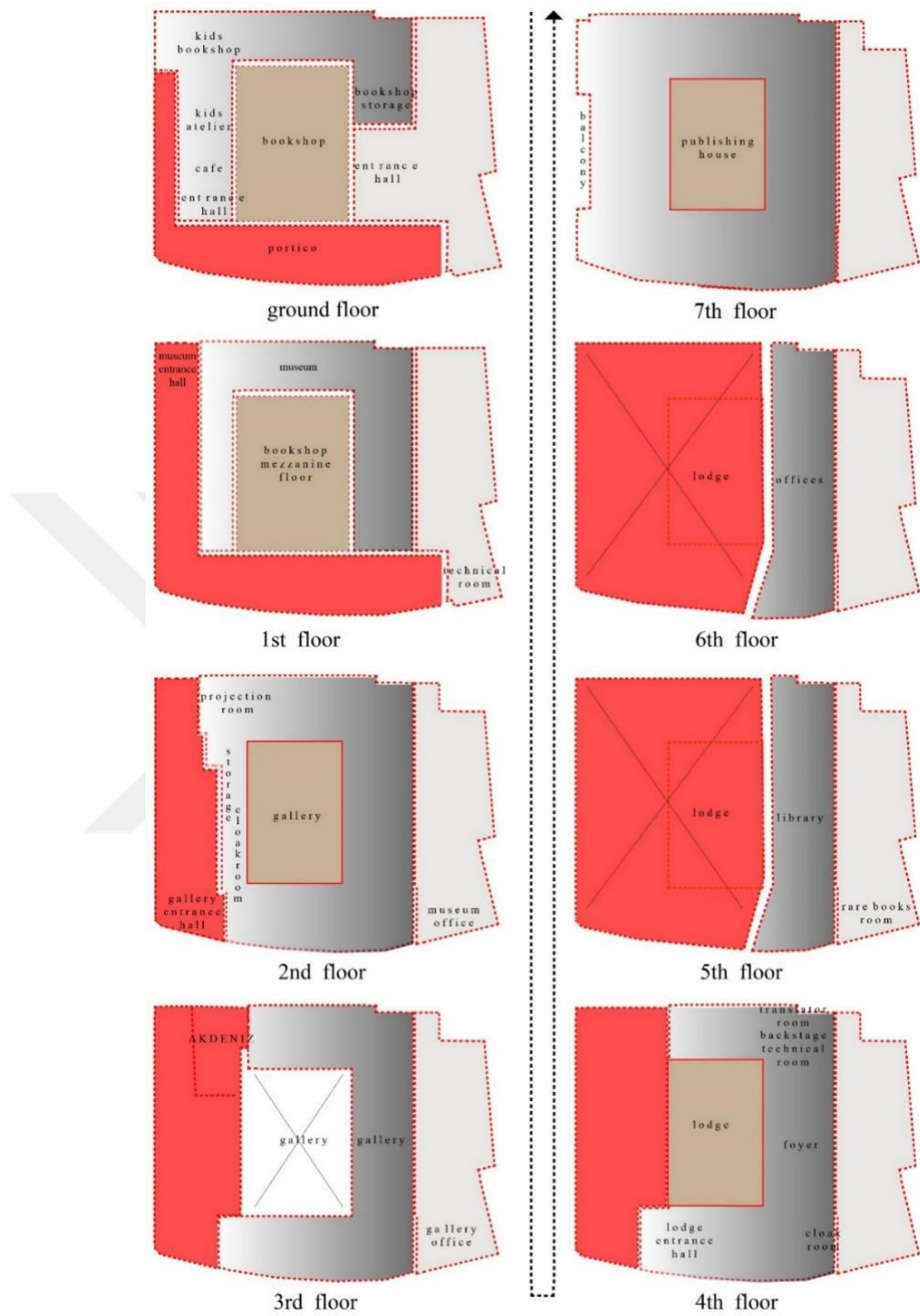

Figure 3.8. The diagram demonstrating the spatial organization of floor levels of the YKKS building.

On the first floor there are three different space characters where the observer can experience different overlapping vistas. The first overlap, is on the mezzanine of the book shop. In this image the İstiklal street, the portico space, and the book store's interior conjoin.

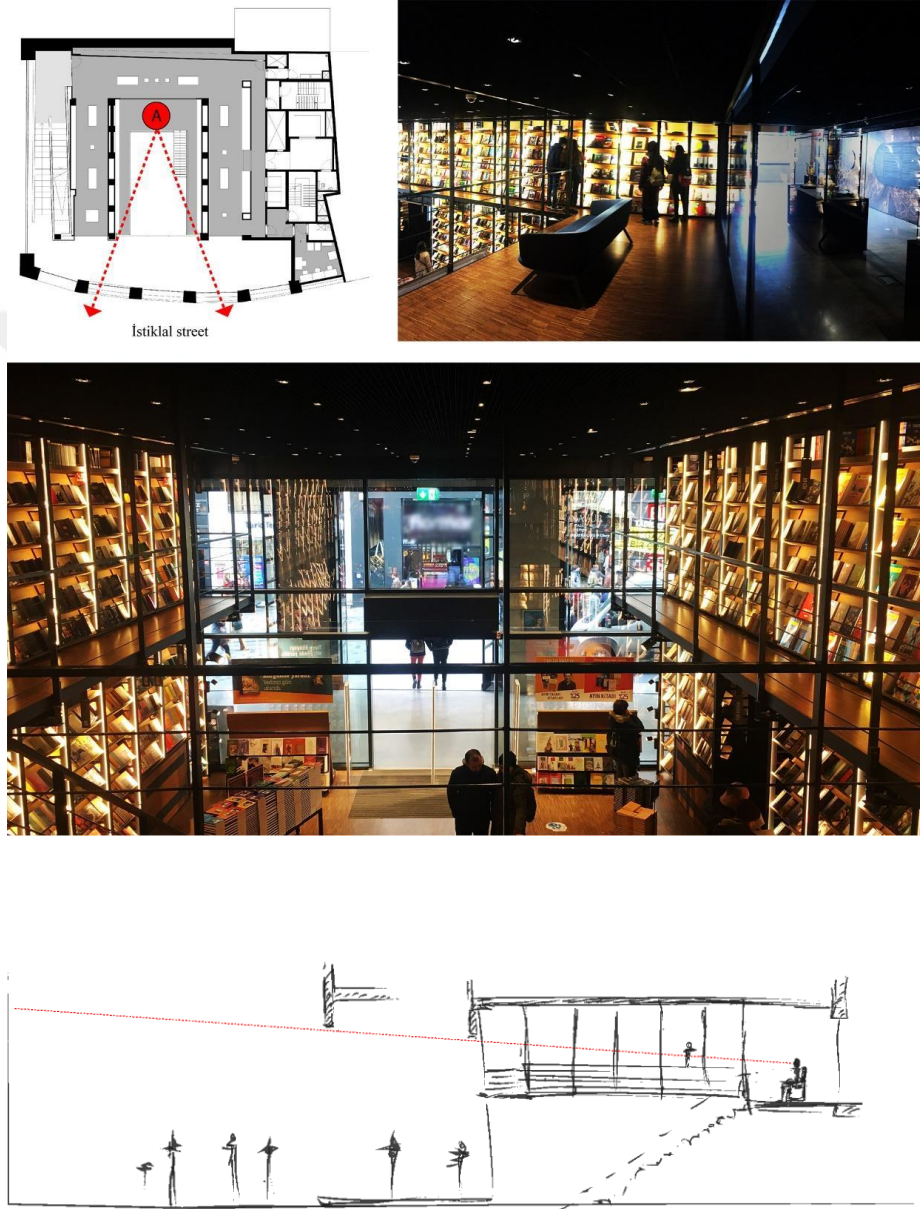

Figure 3.9. Plan, section and photographs showing the visual connection provided at the defined spot A.

The second overlap, emerges right behind the glass that separates the library from the museum. This is the vista that mingle the library space, the portico and the İstiklal street. The image does not only create a possibility for multiple interactions but also enlarges the observer's space by adding the observed volumes to itself.

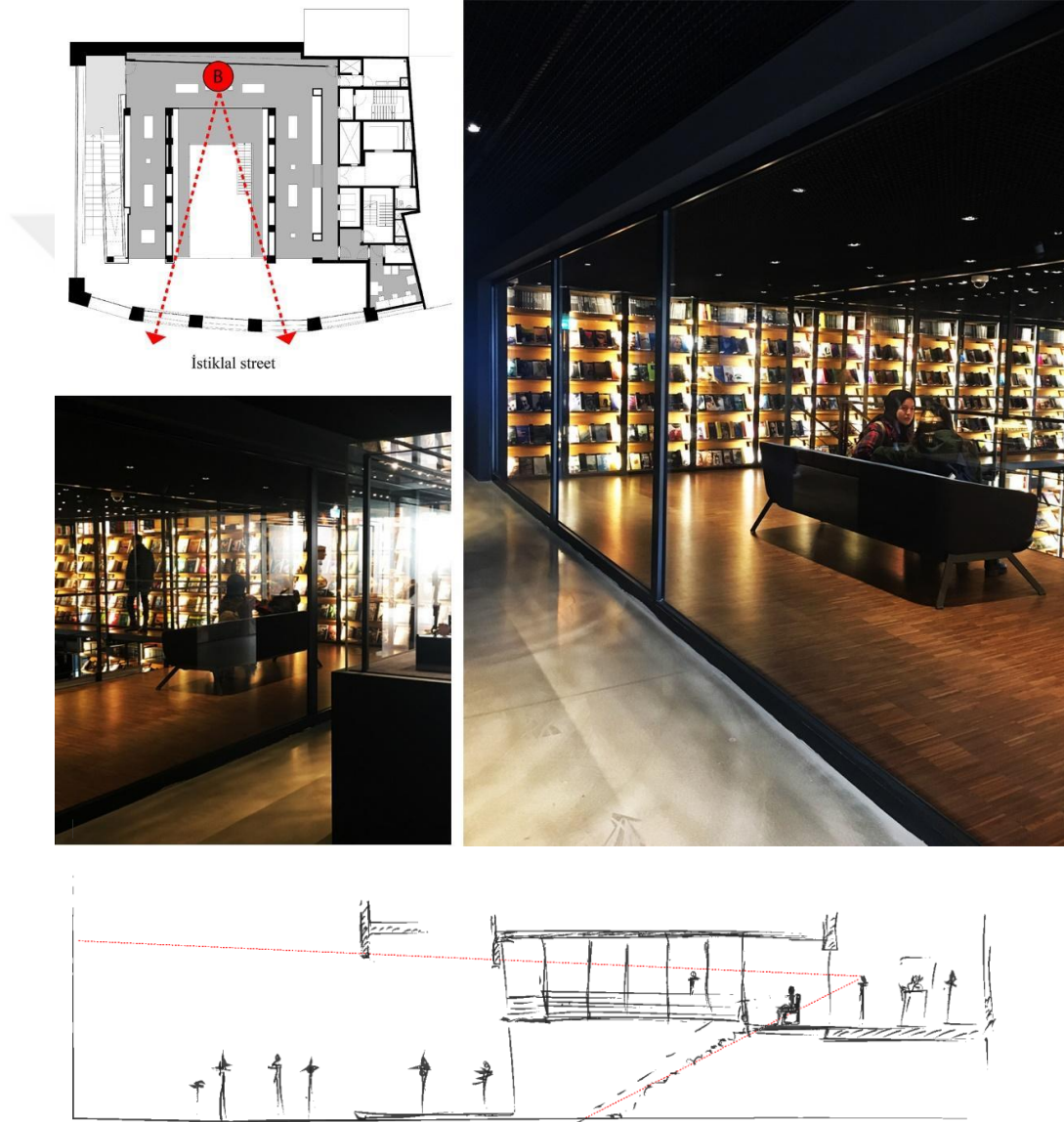

Figure 3.10. Plan, section and photographs showing the visual connection provided at the defined spot B.

The last overlapping image on the first floor appears at both ends of the U-shaped museum plan. At these ends, it is possible to observe the portico space from above against the backdrop of İstiklal street.



Figure 3.11. Plan, section and photographs showing the visual connection provided at the defined spot C.

On the second floor the central gallery space, two-floors high, can be examined from different viewpoints. There are three spots in the exhibition hall, where spaces with different depth and light qualities provide various interactions, standalone or in unison, to please one's perception.

From point A, the central exhibition hall and the second-floor gallery space can be seen together, and the timid, lightened stairwell that highlights the link between the spaces and hints about the flow of movement.

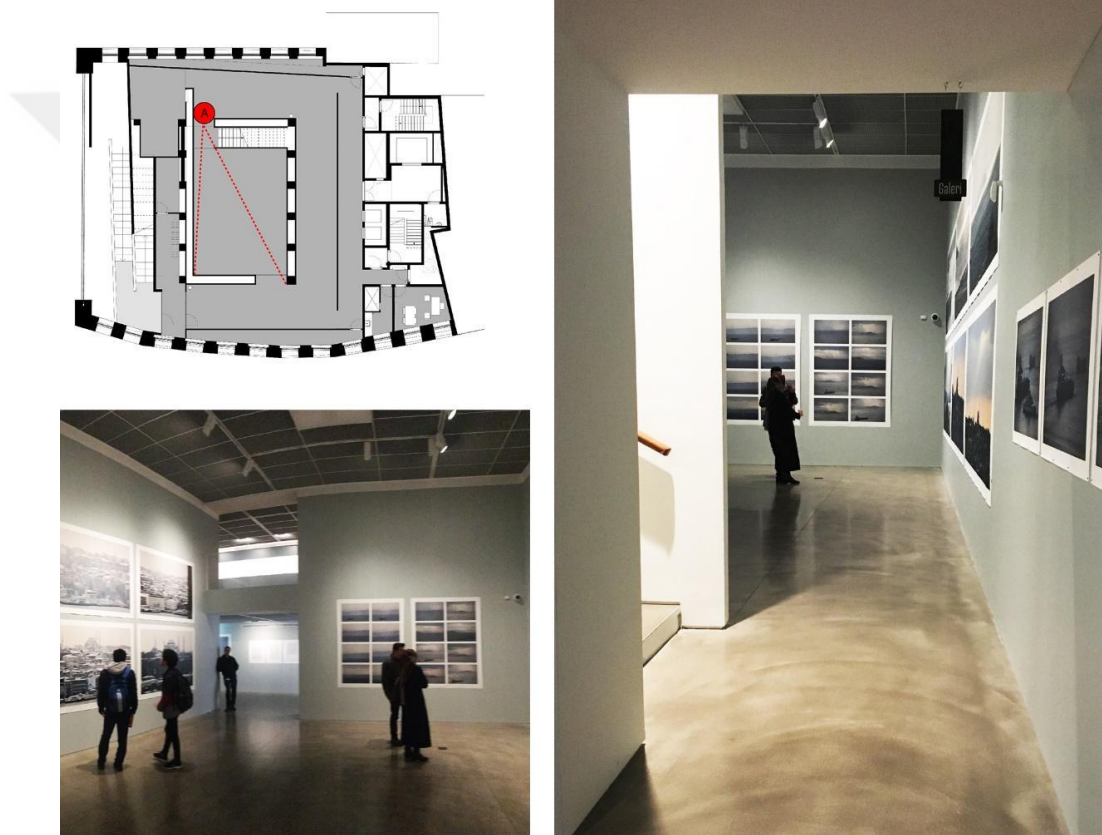

Figure 3.12. Plan and photographs showing the visual connection provided at the defined spot A on the second floor.

Differently from other floors of the building, on the second and the third floor, the perceived negotiation with the surrounding fabric of the city is being minimized and all the attention of the observer is lured indoors. However, at the one end of the U-shaped exhibition corridor, a window place suddenly confronts the observer with the city, the vertical promenade and the sculpture entitled ‘Akdeniz’ [the Mediterranean], rising tall on the third-floor landing of the promenade.



Figure 3.13. Plan and photographs showing the visual connection provided at the defined spot B on the third floor.

The lodge space on the fourth floor is the place where the vertical promenade reaches its peak and offers a vista gridded by the preserved columns of the old Yapı Kredi building. On this level, interior observer watches the outside behind Schmitthenner's columns. Experiencing the fabric of the old city in a new void and in the back of the old structural order gives the lodge space a special importance that makes it one of the extremities of the building, where the old and the new meet in a very intense construct.

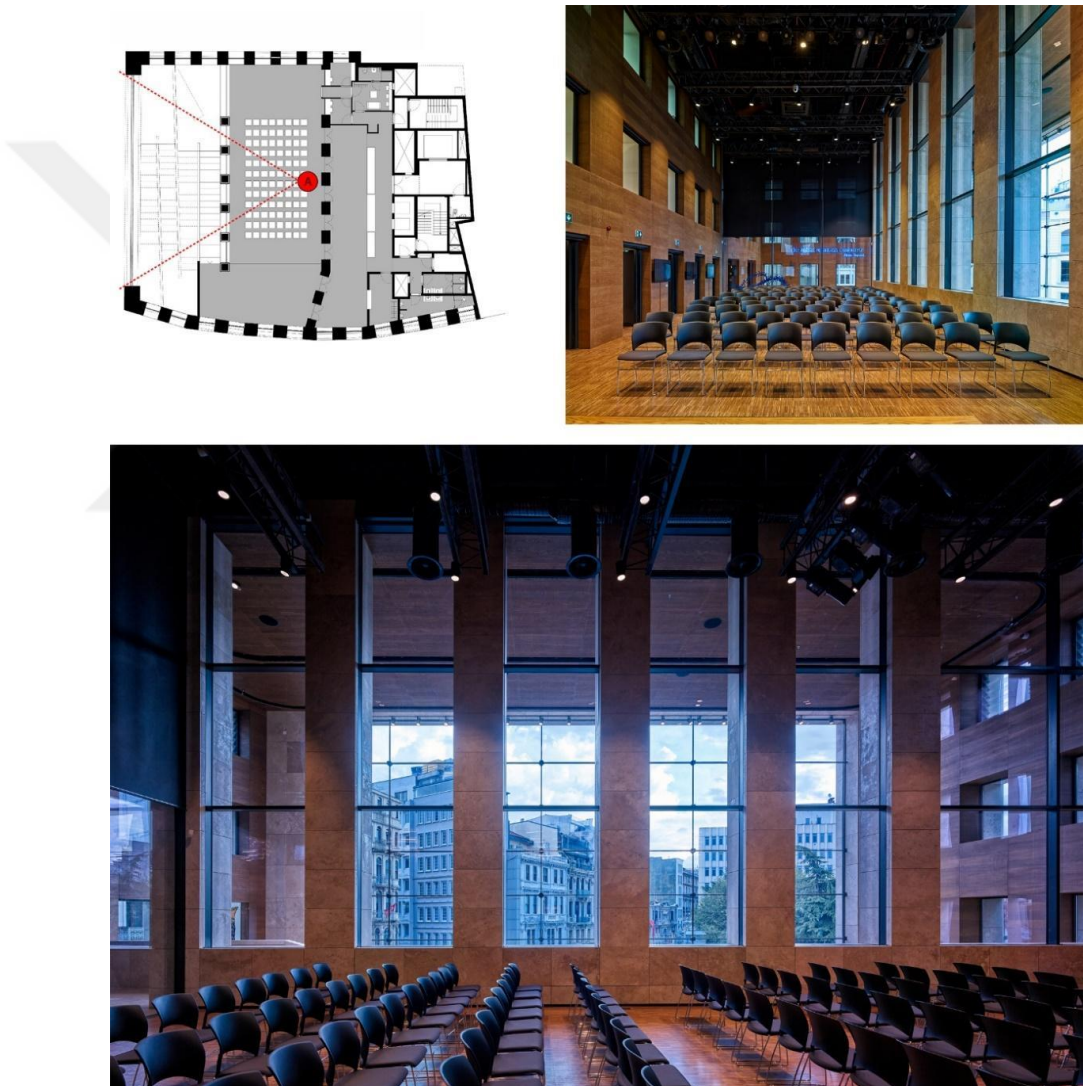

Figure 3.14. Plan and photographs showing the visual connection provided at the defined spot A on the fourth floor. Courtesy of Teğet Archives.

The library on the fifth floor and the offices on the sixth, also have views in which the city and the vertical void of the building merge. However, the continuing order of the preserved façades on the wall that stands between these places and the lodge, seems as if it is the embedded façade of the building. This perception, allows to insulate the private functions without distinction. Thus, even within the most retracted space in the void of the structure, people are not allowed to lose their visual connection with their surrounding volumes.

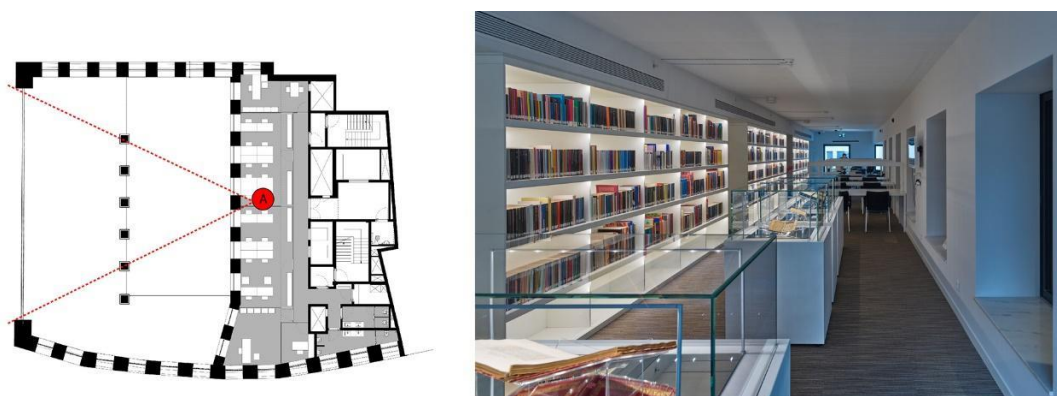

Figure 3.15. Plan and photograph showing the visual connection provided at the defined spot A on the fifth floor. Courtesy of Teğet Archives.

On the sixth floor, the office floor is linked with a glass surface placed beneath the large truss system. Teğet highlights the importance of this truss system by declaring it as a tool to transform old values. This declaration culminates in its real-life apparition at the top of the building asymmetrically almost like the designer's signature.<sup>59</sup>

<sup>59</sup>Kütükçüoğlu, B. Bugatti, E. (2019, April), *'An Opening to the City'*, Yapı Kredi Publications, p.85



Figure 3.16. Photograph showing the provided visual connection on the top floor. Courtesy of Teĝet Archives.

Teĝet decision also to enrich the building's indoor transparency provides various compositions in which the old and the new blend, transform into or intersect with each other. By means of literal and phenomenal transparency, several forms of watching and being watched take place almost in every indoor-space of the structure. This continued visual relation provides a perception of a public space that allows users to contextualize themselves.

### 3.3. Detail Scale

As discussed above, details do not always refer to a construction detail which has real material quality but also represents mediation constituted between a set of values.<sup>60</sup> In the case of the selected building, the detail scale analyses aim to examine the mediation between these sets of values -namely, the old and the new. Old values are identified in the chapter 'Detail Scale-Old Values' as; windows, columns and cladding details. Considering these old values defined as extremities, the mediation that emerges between the old and the new will be analyzed.

---

<sup>60</sup>Schwartz, C. (2016). *Introducing architectural tectonics - exploring the intersection of design*. Taylor & Francis Ltd. p.Iviii

### 3.3.1. Fine Line Character | Windows

Teget decides to preserve Schmitthenner's façade facing the İstiklal street with the existing structural mesh and claims to maintain old values of the previous building. However, architectural tectonics can change the definition of the space in the event of any transformation. In the case of the new YKKS, with the floors removed, old windows are no longer perceived separately on each floor level but as a whole in the total volume of the building mass. This shifting perception of the window openings totally transformed the purpose of the entire design of old windows. Although the windows still retain the same order and observe the same geometry, the way they are experienced has been altered.

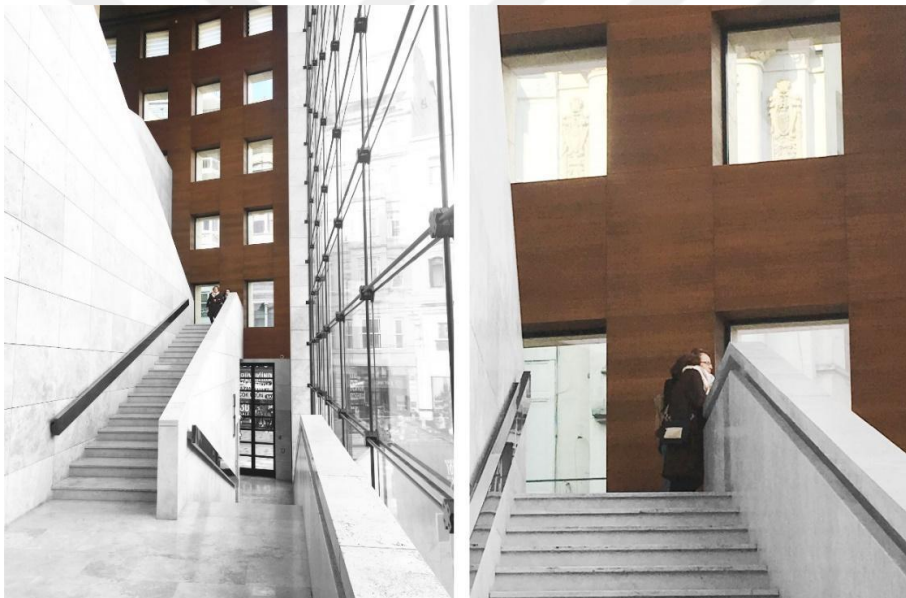

Figure 3.17. Photographs showing the interior surface of the preserved street-facing façade.

With the disappearing slabs, the windows can no longer be considered as single units. Even though they provide glimpses of the view behind, they act together as a whole. Consequently, it can be said that, Teget transforms the negative window space into a positive wall surface and for both an interior observer and an outdoor viewer

the boundaries of the building façade is drawn by solid state of the wall rather than the voids of the openings.

In this way, the façade of the building becomes an ambiguous part of both indoor and outdoor spaces, at once.

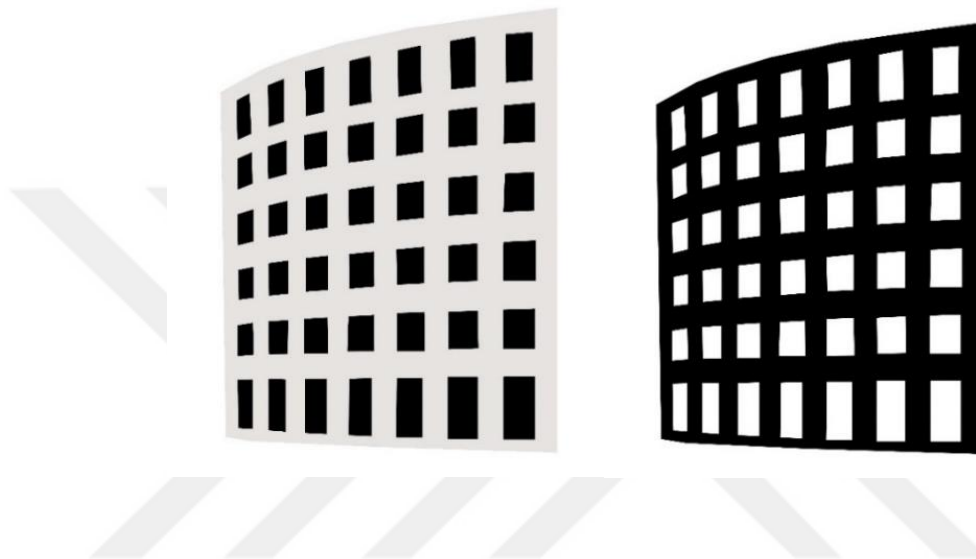

Figure 3.18. Diagrams illustrating the changing solid and void perception of the street façade for an observer.

### 3.3.2. Fine Line Character | Columns

The preserved columns, which originally defined the double height old gallery space, are adapted to the new architecture as iconic elements. The six columns which rise at the back of the interior, surrounds the lodge space on the fourth floor. It is important to understand that, although these old elements are not destroyed, their role in the overall building space has been changed. Considering Schmithenner's open portico, it can be said that the image of the colonnaded open portico is transformed into the elevated enclosed space defined by dramatically rising columns.

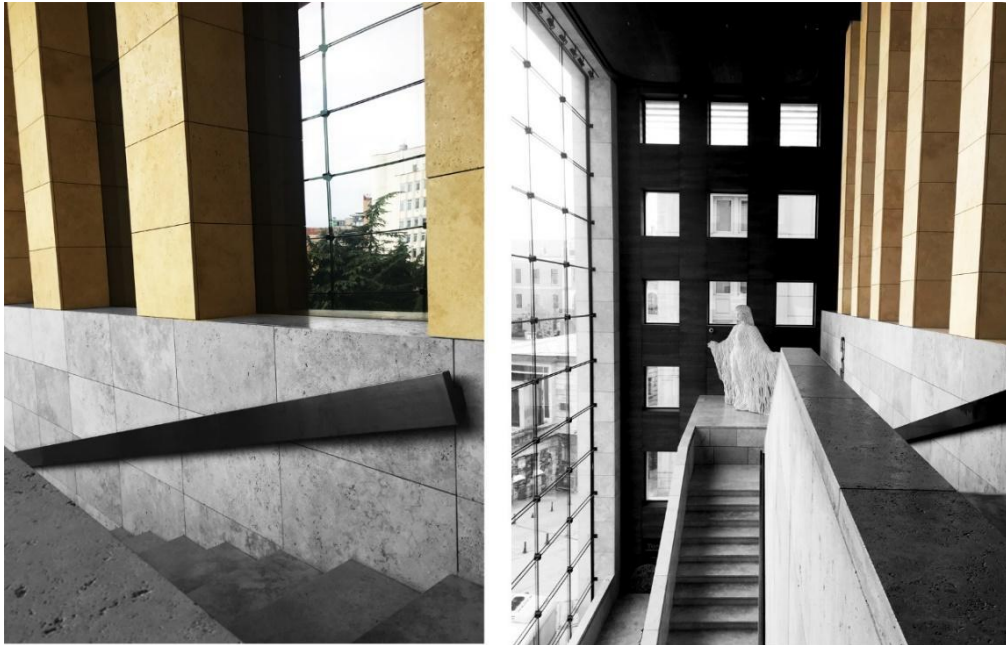

Figure 3.19. Diagrams illustrating the changing solid and void perception of the street façade for an observer.

The reflective-mirror-like-glass of preference also amplifies the depth of the columns, disguising their interior function. Therefore, the elevated enclosed space seems as if it envelopes a noble function that calls to experience. Thus, the changing role of old values, generates a dramatic space-quality which invites people to climb up and explore.

### 3.3.3. Fine Line Character | Cladding

Adolf Loos, in his manifesto ‘The principle of cladding’ interprets the act of cladding as the foundation of architecture. The quality of the inhabitants’ experience depends on the way that the ceiling, floor and walls are clad.<sup>61</sup> According to Loos’s, cladding is what gives the tectonics of a building its character and lights up a dialogue with observers. Virginia Woolf asserts, “There is much to support the view that it is

---

<sup>61</sup>Loos, A. (1897). The principle of cladding. *Spoken into the Void: Collected Essays, 1900*, 66-69.

clothes that wear us and not we them; [...] they mold our hearts, our brains, our tongues to their liking.”<sup>62</sup> The same relation can be possible also for the spatial characteristic and the cladding design of a building.

Regarding significant interpretations of Loos and Woolf on the importance of wrapping, it would not be so generous to say that the overall presence of the building YKKS is monolithic in appearance due to the travertine cladding. Teget preserves the cladding material choice of the old building and amplifies its effect by using it also in the interior space. The perception created with the flow of the cladding material through the interior surfaces, removes the boundaries between the building and the city and aims to declare its common space identity.



Figure 3.20. Photograph showing the cladding strategy of YKKS building, courtesy of Teget Archives.

---

<sup>62</sup>Woolf, V., In Lyons, B., & Gilbert, S. M. (2019). *Orlando: A biography*. p.180



## CHAPTER 4

### CONCLUSION

This study intends to understand the ‘fine line’ character of YKKS building by means of a creative vocabulary. In this manner, the work assesses the concept of ‘*tangent*’ as the keyword, the bedrock on which this vocabulary is built upon. Three main keywords of this vocabulary are selected in reference to the inquiry of the term ‘tangent’ in its specific field. The analysis on the term ‘tangent’ showed that in mathematics, a tangent line aims to learn about the inconstant curve’s behavior and by doing so it develops unique approaches, which are; inherent duality, reducing distance and extremity. This thesis examines and explores the methods that the ‘tangent’ concept has, and uses them to find a way to approach main questions that are asked with the aim to comprehend the ‘fine line’ character of the selected building.

The questions; ‘What is old and what is new?’ ‘to which extent the old and the new values should be evaluated?’ and ‘whether or not the negotiation between the old and the new values can be interpreted as a successful togetherness?’ aim to enlighten the unique way of building’s negotiation between preservation and transformation.

The inherent duality of the concept ‘tangent’ provides the backbone for the analysis within this study. In reference to this quality of the term, it can be said that the inquiry into the selected building consists two main parts. Chapter 3, provides a comprehensive understanding on the old values of the building in order to prepare a basis whereby the dialogue between the new and the old can be understood. Chapter 4, examines new values within the old and seeks to have an idea about how

the old values are transformed or preserved. All in all, to provide the answer to the initial question: ‘What is old and what is new?’ which is the quest of this work.

Rodolfo Machado accepts the past as the material to be altered and reshaped to create a new opportunity.<sup>63</sup> In relation to Machado’s view, if the old values of the YKKS building are accepted as the very first material of the new architectural approach of ‘Teğet,’ then the examination of the new whole cannot be thought independently from the ‘material.’ Therefore, the investigation of material in other words the old values should be comprehensive. With this aim, not only the old Yapı Kredi building but also the history of the building’s plot, the changing blocks in the same plot, Yapı Kredi Bank’s vision and the German architect Schmitthenner’s architecture are all examined in fine detail. This survey provides a context for the examination of the old Yapı Kredi Building designed by Paul Schmitthenner.

The analysis of the old Yapı Kredi building follows the method of ‘reducing distance’ within the overall ‘tangent’ concept. The purpose of the tangent line in mathematics is to understand the whole attitude of a curve graphic by seeing it on an ‘infinitely small’ scale. In other words, as we zoom in, closer and closer, it is possible to capture the whole graphic more clearly. Regarding the ‘reducing distance’ quality of tangent, the structure was investigated in urban, building and detail scales. On the urban scale, the arcade and the facades; on the building scale, the structural order and structural space and on the detail scale, windows, columns and the cladding system are defined as extremities. In every scale the negotiation between the new and the old values, involves significant dialogues which this thesis seeks to elucidate and learn. It is important to remark that each scale generates its own constant (historical) and inconstant (new) values within its context. Therefore, the old and the new values can be redefined in every scale in changing contexts.

---

<sup>63</sup>Machado, R. (1976). Old buildings as palimpsest. Towards a theory of remodeling. *Progressive architecture*, 11, pp.46-49.

In the book, 'Elements of Architecture,' Pierre von Meiss explains how the context and the object relation could vary from scale to scale. According to him, from an urban scale, a building may appear as an object in the background of an urban fabric; from a building scale, the elements like columns, doors, windows, niche hearth, altar, etc. can be objects; and from the detail scale, a door handle can be an object while the door becomes a background.<sup>64</sup>

As stated above, by defining the extremities of the selected building, this study aims to reveal the negotiation disguised in-between the old and the new values. This inquiry considers the 'extremity' as the meeting of the elements of a meaningful whole. In the case of this study, the building's architectural design can be interpreted as a whole involving old and new values. Therefore, examining the extremities of old and new values of the building in scales of urban, building and detail help to figure out the 'fine line' character and help to answer the question 'Whether or not the negotiation between the old and the new values can be interpreted as a successful togetherness?'

According to Robert Venturi, a duality can become a whole if the fragments of the whole inflect.<sup>65</sup> Venturi gives a successful example of continuity in the duality between the structure and the form of the Cabriole legs.<sup>66</sup> The curvilinear form of the legs are connected to the body of the structure in a way that the joints cannot be distinguished in the unity of the design object. However, as we look closer and zoom further in, in their extremities it can be said that there is a contradiction between the structural logic and the form of the material.

---

<sup>64</sup>Von, M. P. (2014). *Elements of architecture: From form to place*. Routledge.pp.93-115

<sup>65</sup>Venturi, R., The Obligation Toward the Difficult Whole, in: *Complexity and Contradiction in Architecture*, The Museum of Modern Art Papers on Architecture, 1996, 2nd. Ed. 1977, p.88-105

<sup>66</sup>Ibid.

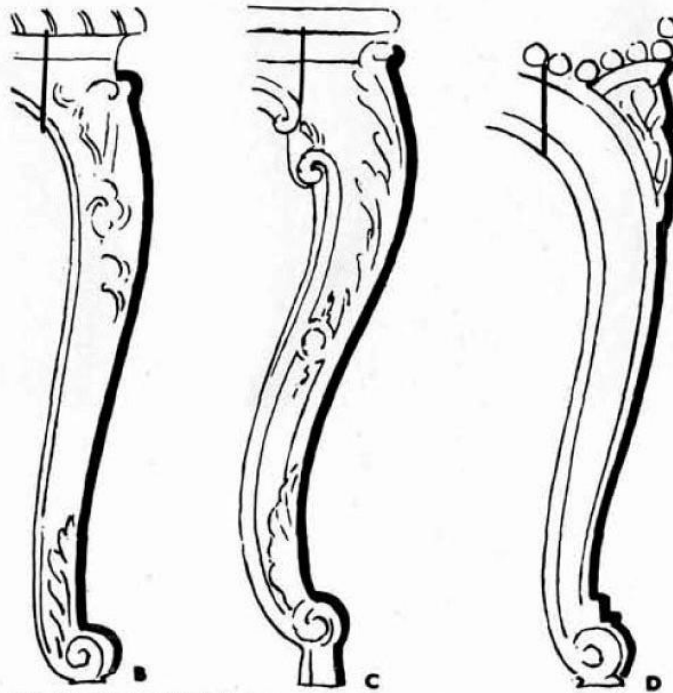

Figure 4.1. Studies for the Cabriole legs (Venturi, R., *The Obligation Toward the Difficult Whole*, in: *Complexity and Contradiction in Architecture*, p.88-105)

This study interprets the inflection as a successful togetherness, which indicates that there is a ‘continuous’ character at the moment of extremity. Accordingly, this study aims to reveal the negotiation disguised in-between the old and the new values. As Chad Schwartz claims that intersections in a building should not be examined only through architectural details, but also towards the convergence of ‘construction systems, ordering principles, narrative paths, or other systems that have a profound impact on the understanding of architecture.’ For this reason, this study also aims to reveal the disguised convergence existing not only in the architectural details but also in the varying systems of values.

Changing values on the urban scale can be considered as the first signs which provide clues about the ‘fine line’ character of the building. Teget’s decision on preserving the arcade plinth and the façade order of the street-facing façade

while removing the old façade and elevating the void of the arcade through the building's vertical void at the square-facing façade shows that new values take their essence from the old and develop within the old. Thus, all values, old and new, on the urban scale are flirtatious with their dramatically contrasted character but also within their underestimated relation. Teĝet places great emphasis on transparency for the square-facing façade. Not only the material property of the curtain wall but the spatial depth of the building space, bring together the new and the old values and reflect a playful composition in which older values develop new roles.

In the examination through the building scale, the analysis considers Schmitthenner's investigation. It is obvious that for him the architectural space should be certainly bound to the idea of the structural order. He uses the term "Baugestaltung" i.e. –'tectonic conception' to express his thoughts on the relation between structural order and space. Regarding the Schmitthenner's ideas on the relation between the structure and the structural space, Teĝet decision on transforming the spatial organization while preserving the structural grid of the old building can be seen as an attractive and provocative attempt. Therefore, considering Schmitthenner's values on tectonics and space relation, on the building scale the extremities are selected as structural order and structural space.

The structural orders of the old and the new buildings were superimposed and the load bearings removed or added were identified. Teĝet's decision to develop new values by removing some elements of the structure was interpreted as the 'stereotomic' approach which creates a new space by means of treatment of the old. Thus the new value of the architectural space is created from and within the old. The transformations in the spatial configurations were mainly constructed upon the concept of 'transparency.' The visual connection between the preserved traces of the gallery, service and transition spaces, emerges as the new value that Teĝet uses to extend the limits of Schmitthenner's structural spaces.

The extremities in the scale of detail were identified by looking at the façade Schmitthenner's drawings. Because there are no detailed drawings of the old building, the existing ones were examined on the scale of detail. This examination highlighted three extremities which are the windows, columns and the cladding. Interestingly these extremities are asserted by Teğet as the values of the old architecture that have been maintained.<sup>67</sup> However, the analysis indicated that despite the preserved order of the windows, gallery space columns and the cladding material, the perception of the details are effected by the changing composition of the tectonics of the building.

In the case of windows, although Teğet Architects respected their order and the simple geometry, with the removed slabs and the void created as such, the function and the figure of the openings have changed. The old portrait rectangular window which is “capable of framing a man and taking everything necessary at each level- some sky, some garden, some pavement – and no more than that”<sup>68</sup> is transformed into an element of the porous surface, which works together with the other window frames and changes its captured views according to the observer's standpoint inside the building. The columns as other extremities of the detail scale also represent a negotiation between the old and the new values. The arcade columns of the old Yapı Kredi building can be considered as one of the representations of the structural order and the composition of the façade. With the curtain wall which replaces the removed arcade columns on the street-facing square, this old value seems to have diminished. However, the new void between the old gallery columns and the outside square enables to view old columns which currently surround the lodge space on the fifth floor. As another value of the detail scale, cladding is one of

---

<sup>67</sup>Kütükçüoğlu, B. Bugatti, E. (2019, April), *'An Opening to the City'*,Yapı Kredi Publications

<sup>68</sup>Davis, B., Koolhaas, R., Trüby, S., Westcott, J., Harvard University (Cambridge, Mass.), & International Architectural Exhibition. (2014). *Elements of architecture*. 'Ribbon vs. Portrait', Venice: Marsilio. p.20

the old values, which helps constitute the formal character of the old building with travertine stone plates. Although one of the reasons to reuse travertine can be due to its effect to constitute an institutional figure and keep the same character as reminiscent of the old building, Teget Architects adds further value by allowing the travertine to flow through the interior of the new building. By means of the continuation of the same material on interior as well as exterior surfaces, the monolithic identity of the new building is created.

In view of the several aspects explained above, an assessment of the 'fine line' character of the selected building' contributes to architectural practice. The analyses studied, provides evidence that the building YKKS inherits various negotiations between the old and the new values. The complex relationships constructed with and within the old, introduce several possible architectural relations, which can be used to transform and preserve an architectural value simultaneously.



## REFERENCES

- Alexander, C., Ishikawa, S., & Silverstein, M. (2010). *A Pattern Language: Towns, Buildings, Construction*. New York: Oxford University.
- Anderson, S. (2002). *Peter Behrens and A New Architecture for the Twentieth Century*. MIT Press.
- Heath, T. L. (1961). *Apollonius of Perga: treatise on conic sections: edited in modern notation: with introductions including an essay on earlier history on the subject*. W. Heffer & Sons.
- Ardito, V. (2015). *Paul Schmitthenner: 1884-1972*. Gangemi Editore spa.
- Ardito, V. Baukunst and The Project of The Construction's Form. Research and Didactics. *TECHNE-Journal of Technology for Architecture and Environment*.
- Bell, J. L. (2006). *The continuous and the infinitesimal in mathematics and philosophy*. Milano: Polimetrica.
- Boettger, T. (2014). *Threshold Spaces: Transitions in architecture analysis and design tools*. Basel, Switzerland: Birkhäuser.
- Davis, B., Koolhaas, R., Trüby, S., Westcott, J. *Elements of architecture*. 'Ribbon vs. Portrait', Venice: Marsilio.
- Deely, J. N. (1982). *Introducing semiotic: Its history and doctrine* (Vol. 287). Indiana University Press.
- Derrek H.F. Ho (2014). Istanbul (1936-1951) / The Regeneration of Beyoğlu District. Asian Cities Research, Retrieved from: <http://dx.doi.org/10.0000/0000>
- Diefendorf, J. M. (1993). In *The Wake of War: The Reconstruction of German Cities After World War II*. Oxford University Press.
- Erlhoff, M., & Marshall, T. (Eds.). (2007). *Design dictionary: perspectives on design terminology*. Walter de Gruyter.
- Ersel, H. (2015). *Kazım Taşkent, Yapı Kredi ve Kültür Sanat*. Yapı Kredi Yayınları.
- Finch, P. (2017). All architecture is about the future – but about the past too. *The Architectural Review*, 1447, opening speech (quotation is retrieved from: T. S.

ELIOT, *New York Post*, September 23, 1963)

Ford, E. R. (2013). *The Architectural Detail*. New York, NY: Princeton Architectural Press.

Gehl, J. (2002). *Life Between Buildings*. Beijing: China Architecture & Building Press.

Heath, T. L. (2010). *Apollonius of Perga: Treatise on conic sections*. Milton Keynes, UK: Lightning Source.

İlgin, I., Akın, G., Boysan, B., & Santral İstanbul (2010). İstanbul 1910-2010: Kent, yapı çevre ve mimarlık kültürü sergisi : [maruz kalma] = city, built environment, and architectural culture exhibition. İstanbul Bilgi University publishing.

Kafka, G. (2017). Opening Statement of the AR New into Old Awards. *The Architectural Review*.

Kardeş, E. (2015). *Türkiye'de özel sektörün kültür yatırımları ve sosyal sermaye: Yapı Kredi örneği* (Doctoral dissertation, İstanbul Bilgi Üniversitesi).

Glaser, M., Van't Hoff, M., & Karsenberg, H. (Eds.). (2012). *The city at eye level: Lessons for street plinths*. Eburon Uitgeverij BV.

Kütükçüoğlu, B. Bugatti, E. (2019, April), 'An Opening to the City', Yapı Kredi Publications.

Kütükçüoğlu, M. & Uçar, E. (2017, November). Interview by Yüksel, H. Z. Binadan Öte Bir Şehir Mekanı. *İstanbul Art News*, Retrieved from <http://www.arkitera.com/soylesi/991/binadan-ote-bir-sehir-mekani>

Loos, A. (1897). The principle of cladding. *Spoken into the Void: Collected Essays, 1900*, 66-69.

Machado, R. (1976). Old buildings as palimpsest. Towards a theory of remodeling. *Progressive architecture*, 11

Matan, A., & Newman, P. (2016). People cities: The life and legacy of Jan Gehl.

Panin, T. (2007). On The Surface: Purposes of Architectural Enclosure. *NAJUA: Architecture, Design and Built Environment*.

Panin, T. (2009). *Architectural spatiality: The dialectic between the concepts of Raum and Bekleidung*. Saarbrücken, Germany: VDM Verlag Dr. Müller.

Schwartzman, S. (2012). *The Words of Mathematics: An Etymological Dictionary of Mathematical Terms Used in English*. Cambridge: Mathematical Association of America. Retrieved from <http://0-search.ebscohost.com.library.metu.edu.tr/login.aspx?direct=true&AuthType=ip&db=nlebk&AN=450262&site=eds-live>

Shenk, A. (1988). *Calculus and analytic geometry*. Glenview, Ill: Scott, Foresman.

Tekeli, I., & Eyice, S. (1994). *Düinden bugüne İstanbul ansiklopedisi: Volume 3*. Istanbul: publication of the Ministry of Culture and History Foundation.

VBenzeri (Producer). (2017, December 8) Interview with Teğet Founders on Marine Museum and Yapı Kredi Culture Centre [Video file]. Retrieved from <https://www.vbenzeri.com/video/teget-mimarlik>

Venturi, R., & Scully, V. (1977). *Complexity and contradiction in architecture* (Vol. I). The Museum of modern art.

Von, M. P. (2014). *Elements of architecture: From form to place*. Routledge.

Woolf, V., In Lyons, B., & Gilbert, S. M. (2019). Orlando: A biography.

Yavuz, F., Tufan, M. (2008). Interview with Mehmet Kütükçüoğlu and Ertuğ Uçar, Mimarlık ‘mesleği’ ve ‘işi’ arasında büro, Mimarizm, Retrieved from [http://www.mimarizm.com/makale/mimarlik-meslegi-ve-isi-arasinda-buro\\_113576](http://www.mimarizm.com/makale/mimarlik-meslegi-ve-isi-arasinda-buro_113576)

Yüksel, H. Z. (2013, November). Interview with Mehmet Kütükçüoğlu on Marine Museum, Art and Design Magazine, no: 44.

Zumthor, P. (2010). *Thinking Architecture*. Basel: Birkhause