



**INVESTIGATION OF FATIGUE BEHAVIOR OF  
3D PRINTED PLA BEAMS REINFORCED WITH  
CARBON FIBERS**

**2022  
MASTER THESIS  
METALLURGICAL AND MATERIALS  
ENGINEERING**

**Husam BAWADIKJI**

**Thesis Advisor  
Prof. Dr. Hayrettin AHLATCI**

**INVESTIGATION OF FATIGUE BEHAVIOR OF 3D PRINTED PLA BEAMS  
REINFORCED WITH CARBON FIBERS**

**Husam BAWADIKJI**

**T.C.  
Karabuk University  
Institute of Graduate Programs  
Department of Metallurgical and Materials Engineering  
Prepared as  
Master Thesis**

**Thesis Advisor  
Prof. Dr. Hayrettin AHLATCI**

**KARABUK  
Aug 2022**

I certify that in my opinion the thesis submitted by Husam BAWADIKJI titled “INVESTIGATION OF FATIGUE BEHAVIOR OF 3D PRINTED PLA BEAMS REINFORCED WITH CARBON FIBERS” is fully adequate in scope and in quality as a thesis for the degree of Master of Science.

Prof. Dr. Hayrettin AHLATCI .....  
Thesis Advisor, Department of Metallurgical and Materials Engineering

This thesis is accepted by the examining committee with a unanimous vote in the Department of Metallurgical and Materials Engineering as a Master of Science thesis. Aug 18, 2022

<u>Examining Committee Members (Institutions)</u>	<u>Signature</u>
Chairman : Assoc. Prof. Dr. Yunus TÜREN (KBU)	.....
Member : Prof. Dr. Hayrettin AHLATCI (KBU)	.....
Member : Prof. Dr. Mustafa ACARER (SU)	.....

The degree of Master of Science by the thesis submitted is approved by the Administrative Board of the Institute of Graduate Programs, Karabuk University.

Prof. Dr. Hasan SOLMAZ .....  
Director of the Institute of Graduate Programs



*“I declare that all the information within this thesis has been gathered and presented in accordance with academic regulations and ethical principles and I have according to the requirements of these regulations and principles cited all those which do not originate in this work as well.”*

Husam BAWADIKJI

## **ABSTRACT**

**M. Sc. Thesis**

### **INVESTIGATION OF FATIGUE BEHAVIOR OF 3D PRINTED PLA BEAMS REINFORCED WITH CARBON FIBERS**

**Husam BAWADIKJI**

**Karabük University**

**Institute of Graduate Programs**

**The Department of Metallurgical and Materials Engineering**

**Thesis Advisor:**

**Prof. Dr. Hayrettin AHLATCI**

**Aug 2022, 74 pages**

Using 3D printing technology has enabled researchers to manufacture complex parts more easily and in less time. One of the most common methods of 3D printing is the FDM method. This technology allows lightweight products to be built using different infill density.

In this research, tensile test and fatigue test are applied to pure PLA and PLA reinforced with carbon fiber to investigate how main 3D printing parameters influence the tensile strength and Fatigue of PLA products. Samples are designed using two infill density percentage, 70% and 100%. The samples are also designed using 3 types of material: (pure PLA, PLA reinforced with 15% carbon fiber, and PLA reinforced with 20% carbon fiber). Tensile and fatigue experiments were conducted on the samples, and the results of the study concluded that the use of PLA, reinforced with 15% carbon fiber, is the one that achieves the highest mechanical

properties. When the percentage of carbon fiber reaches 20%, the mechanical properties of the material deteriorate due to the effect of carbon fiber on the adhesion of the layers of the material during 3D printing.

**Key Words** : 3d Printing technology, Fused Deposition Modeling FDM, Infill designs, Poly lactic acid (PLA).

**Science Code:** 91512



## **ÖZET**

**Yüksek Lisans Tezi**

### **KARBON ELYAF TAKVİYELİ 3D BASKILI PLA KİRİŞLERİN YORULMA DAVRANIŞININ İNCELENMESİ**

**Husam BAWADIKJI**

**Karabük Üniversitesi**

**Lisansüstü Eğitim Enstitüsü**

**Metalurji ve Malzeme Mühendisliği Anabilim Dalı**

**Tez Danışmanı:**

**Prof. Dr. Hayrettin AHLATCI**

**Ağustos 2022, 74 sayfa**

3D baskı teknolojisini kullanmak, araştırmacıların karmaşık parçaları daha kolay ve daha kısa sürede üretmelerini sağladı. 3D baskının en yaygın yöntemlerinden biri FDM yöntemidir. Bu teknoloji, hafif ürünlerin farklı dolgu yoğunluğu kullanılarak oluşturulmasına olanak tanır.

Bu araştırmada, ana 3D baskı parametrelerinin PLA ürünlerinin çekme mukavemetini ve Yorulmasını nasıl etkilediğini araştırmak için saf PLA ve karbon fiber takviyeli PLA'ya çekme testi ve yorulma testi uygulanmıştır.

Numuneler, %70 ve %100 olmak üzere iki dolgu yoğunluğu yüzdesi kullanılarak tasarlanmıştır.

Numuneler ayrıca 3 tip malzeme kullanılarak tasarlanmıştır: (saf PLA , %15 karbon fiber takviyeli PLA ve %20 karbon fiber takviyeli PLA).

Numuneler üzerinde çekme ve yorulma deneyleri yapılmış ve çalışmanın sonuçları, %15 karbon fiber takviyeli PLA kullanımının en yüksek mekanik özelliklere sahip olduğu sonucuna varmıştır. Karbon fiber yüzdesi %20'ye ulaştığında, 3D baskı sırasında karbon fiberin malzemenin katmanlarının yapışmasına etkisi nedeniyle malzemenin mekanik özellikleri bozulur.

**Anahtar Kelimeler :** 3D Printing technology, Fused Deposition Modeling FDM, Infill designs, Poly lactic acid (PLA).

**Bilim Kodu** : 91512

## ACKNOWLEDGMENT

Yesterday it was an idea. and today it has become a thesis. And the dream has become a reality. And hope has become a reality. And effort has yielded success. And supplication has been manifested in response, and the darkness has shone light.

I owe thanks to Allah Almighty for the blessing of knowledge and determination to search, Alhamdulillah who eased difficulties for me, and made it easy for me from the most faithful professors.

I also owe a lot of thanks to my supervisor Prof. Dr. Hayrettin AHLATCI, who did not hesitate to provide guidance and knowledge, and he was my first reference in this research.

I also owe a lot of thanks to Prof. Dr. İsmail ESEN Who helped me in my research, and gave me many valuable scientific advice and information.

I do not forget to give credit to all my professors at the University of Aleppo and the Syrian Virtual University, especially Dr. Khaled Estifi, Dr. Qassem Jabawi, Dr. Ahmed El-Sayed and Dr. Obeida Al-Sahli

I also extend my thanks and gratitude to the Karabük University, management and professors, for what they have given me during my university life.

I ask Allah Almighty to benefit me with my knowledge and to make me one of those who invest his knowledge in the service of society.

## CONTENTS

	<u>Page</u>
APPROVAL.....	ii
ABSTRACT.....	iv
ÖZET.....	vi
ACKNOWLEDGMENT.....	viii
CONTENTS.....	ix
LIST OF FIGURES.....	xii
LIST OF TABLES.....	xiv
SYMBOLS AND ABBREVIATIONS INDEX.....	xv
PART 1.....	1
INTRODUCTION.....	1
1.1. RESEARCH PROBLEMS.....	3
1.2. IMPORTANT OF RESEARCH.....	3
1.3. RESEARCH OBJECTIVES.....	4
1.4. RESEARCH COMMUNITY AND DELIMITATION.....	4
1.5. RESEARCH PROCEDURE.....	5
1.6. DEFINITIONS.....	5
PART 2.....	7
THEORETICAL BACKGROUND.....	7
2.1. INTRODUCTION.....	7
2.2. BASIC STAGES OF 3D PRINTING.....	8
2.3. THREE D PRINTING TECHNIQUES.....	9
2.3.1. Powder Bed Fusion.....	9
2.3.1.1. SLS: Selective Laser Sintering.....	9
2.3.1.2. DMLS: Direct Metal Laser Sintering.....	11
2.3.1.3. SLM: Selective Laser Melting.....	12
2.3.1.4. EBM: Electron Beam Melting.....	13

	<u>Page</u>
2.3.1.5. MJF: Multi JET Fusion .....	15
2.3.2. FDM: Fused Deposition Modeling .....	17
2.3.3. DED: Direct Energy Deposition .....	19
2.3.3.1. LENS: Laser Engineered Net Shape .....	19
2.3.3.2. EBAM: Electron Beam Additive Manufacturing .....	20
2.3.4. Vat Photopolymerization .....	22
2.3.4.1. SLA: Stereolithography .....	22
2.3.4.2. Digital Light Processing: DLP: Digital Light Processing.....	23
2.4. PRINTING MATERIALS .....	25
2.4.1. Plastic Materials .....	25
2.4.1.1. ABS: Acrylonitrile Butadiene Styrene.....	26
2.4.1.2. PET: Poly Ethylene Terephthalate.....	27
2.4.1.3. PETG: Poly Ethylene Terephthalate Glycol.....	27
2.4.1.4. TPU: Thermo Plastic Polyurethane .....	27
2.4.1.5. Nylon (Polyamide).....	28
2.4.1.6. PC: Polycarbonate.....	28
2.5. INFILL PATTERN .....	29
2.5.1. Infill Patterns Types.....	30
2.6. INFILL DENSITY .....	31
2.7. INTRODUCTIONS TO FATIGUE TEST.....	32
2.8. DEFINITION OF FATIGUE .....	33
2.9. PURPOSE OF FATIGUE TEST.....	34
2.10. FATIGUE ANALYSIS .....	34
PART 3.....	36
LITERATURE REVIEW.....	36
3.1. FIRST STUDY ENTITLED .....	36
3.2. SECOND STUDY ENTITLED .....	37
3.3. THIRD STUDY ENTITLED .....	38
3.4. FOURTH STUDY ENTITLED .....	39
PART 4.....	41
METHODOLOGY.....	41

	<u>Page</u>
4.1. MATERIALS AND DESIGN .....	41
4.2. PRINTING AND PROCESS PARAMETERS .....	42
4.3. EXPERIMENTATION .....	46
4.3.1. Tensile Test.....	46
4.3.2. Fatigue Test .....	51
 PART 5.....	 57
RESULTS, DISCUSSION AND SUMMARY .....	57
5.1. RESULTS AND DISCUSSION .....	57
5.1.1. Tensile Test.....	57
5.1.2. Fatigue Test .....	59
5.1.3. Scanning Electron Microscopic (SEM) .....	63
 PART 6.....	 68
RECOMMENDATIONS AND PROPOSALS.....	68
6.1. RECOMMENDATIONS .....	68
6.2. PROPOSALS .....	68
 REFERENCE.....	 70
 RESUME.....	 74

## LIST OF FIGURES

	<u>Page</u>
Figure 1.1. Printer makes layers .....	1
Figure 1.2. Difference between Additive vs. Subtractive Manufacturing .....	2
Figure 2.1. Build layers one on top of the other .....	7
Figure 2.2. Building in the UAE built using 3D printing .....	8
Figure 2.3. Working principle of SLS technology .....	10
Figure 2.4. Working principle of SLM . .....	12
Figure 2.5. EBAM Technology Working Principle .....	14
Figure 2.6. Skull Brace made by EBAM metode .....	15
Figure 2.7. Working principle of the MJF method . .....	16
Figure 2.8. Hand piece made with MJF technology .....	17
Figure 2.9. Working principle of FDM technology .....	18
Figure 2.10. Prosthetic limb made using FDM technology .....	19
Figure 2.11. Working principle of the LENS method .....	20
Figure 2.12. EBAM Technology Working Principle .....	21
Figure 2.13. Working principle of the SLA method . .....	22
Figure 2.14. Principle of DLP Technology .....	24
Figure 2.15. Various types of printing materials.....	25
Figure 2.16. Some forms of filling patterns .....	29
Figure 2.17. Different proportions of infill density.....	32
Figure 3.1. Results of first Reference Study . .....	37
Figure 3.2. Results of second Reference Study .....	38
Figure 3.3. Results of third Reference Study . .....	39
Figure 3.4. Results of fourth Reference Study .....	40
Figure 4.1. Fatigue Test Design .....	41
Figure 4.2. Tensile Test Design .....	42
Figure 4.3. Ender3 pro 3d printer .....	43
Figure 4.4. Cura slicing application for 3D printers .....	44
Figure 4.5. Tensile sample at Cura application .....	44
Figure 4.6. Slice option in Cura application.....	45

	<u>Page</u>
Figure 4.7. Prepare the sample into layers .....	46
Figure 4.8. 3D printer during sample printing process .....	46
Figure 4.9. Tensile test curve for (Sample 1).....	47
Figure 4.10. Tensile test curve for (Sample 2).....	48
Figure 4.11. Tensile test curve for (Sample 3).....	48
Figure 4.12. Tensile test curve for (Sample 4).....	49
Figure 4.13. Tensile test curve for (Sample 5).....	49
Figure 4.14. Tensile test curve for (Sample 6).....	50
Figure 4.15. Tensile test curve for all samples.....	50
Figure 4.16. Guided Cantilever Beam .....	52
Figure 4.17. S-N Curve for (Sample 1).....	53
Figure 4.18. S-N Curve for (Sample 2).....	53
Figure 4.19. S-N Curve for (Sample 3).....	54
Figure 4.20. S-N Curve for (Sample 4).....	54
Figure 4.21. S-N Curve for (Sample 5).....	55
Figure 4.22. S-N Curve for (Sample 6).....	55
Figure 4.23. Number of cycles to failure N .....	56
Figure 5.1. Ultimate tensile strength for All Samples.....	57
Figure 5.2. Young's modulus for all Samples .....	58
Figure 5.3. S-N Curve for All Samples with gridlines.....	62
Figure 5.4. SEM micrographs of cross section (15%cp, 100% infill) .....	64
Figure 5.5. SEM micrographs of cross section (15%cp, 70% infill) .....	64
Figure 5.6. SEM micrographs of cross section (20%cp, 100% infill) .....	65
Figure 5.7. SEM micrographs of cross section (20%cp, 70% infill) .....	65
Figure 5.8. SEM micrographs of cross section (0%cp, 100% infill) .....	66
Figure 5.9. SEM micrographs of cross section (0%cp, 70% infill) .....	66

## LIST OF TABLES

	<u>Page</u>
Table 2.1. Pros and cons of the SLS method.....	11
Table 2.2. Pros and cons of the DMLS method .....	11
Table 2.3. Pros and cons of the SLM method .....	13
Table 2.4. Pros and cons of the EBM method.....	14
Table 2.5. Pros and cons of the MJF method .....	16
Table 2.6. Pros and cons of the FDM method.....	18
Table 2.7. Pros and cons of the DED method .....	20
Table 2.8. Pros and cons of the EBAM method.....	22
Table 2.9. Pros and cons of the SLA method.....	23
Table 2.10. Pros and cons of the DLP method.....	24
Table 2.11. Pros and cons of the PLA material.....	26
Table 2.12. Pros and cons of the ABS material .....	26
Table 2.13. Pros and cons of the PET material .....	27
Table 2.14. Pros and cons of the PETG material .....	27
Table 2.15. Pros and cons of the TPU material.....	28
Table 2.16. Pros and cons of the NYLON material .....	28
Table 2.17. Pros and cons of the PC material .....	28
Table 4.1. 3D printing parameters used in the research .....	45
Table 5.1. Results of tensile test for all samples .....	57
Table 5.2. Results of fatigue test for the sample (15% cp 100% Infill).....	60
Table 5.3. Results of fatigue test for the sample (15% cp 70% Infill).....	60
Table 5.4. Results of fatigue test for the sample (20% cp 100% Infill).....	60
Table 5.5. Results of fatigue test for the sample (20% cp 70% Infill).....	60
Table 5.6. Results of fatigue test for the sample (0% cp 100% Infill).....	61
Table 5.7. Results of fatigue test for the sample (0% cp 70% Infill).....	61

## SYMBOLS AND ABBREVIATIONS INDEX

$\delta$  : Maximum amount of bending deformation.

$N$  : Number of cycles to failure for a material.



## PART 1

### INTRODUCTION

Additive Manufacturing or 3D Printing technology, also known as Additive Manufacturing, refers to processes used to produce a 3D sample. This technique works by add layers of material are successively (with difference layer height) formed under a computer controlled software to create a physical sample.

These kinds of technologies have recently been successfully utilized in numerous engineering applications.

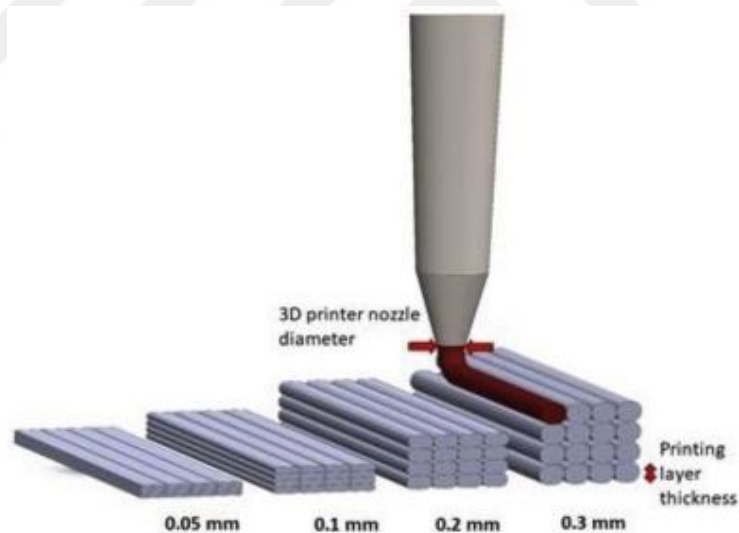

Figure 1.1. Printer makes layers [27].

The key difference between Additive (3d printing) vs. Subtractive Manufacturing is that 3D printing is a form of additive manufacturing, while CNC Milling is subtractive. This means CNC Milling starts with a block of material (called a blank), and cuts away material to create the finished part. To do this, cutters and spinning tools are used to shape the piece. Some advantages of CNC machining include great

dimensional accuracy as well as many compatible materials, including wood, metals and, plastics...

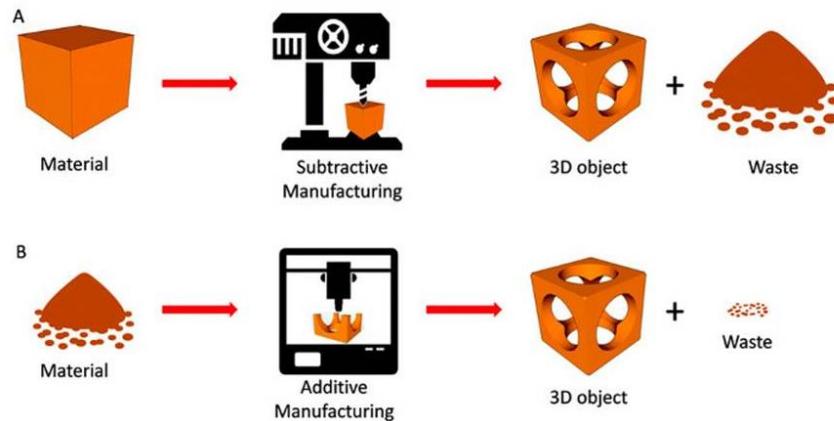

Figure 1.2. Difference between Additive vs. Subtractive Manufacturing [28].

Methods which fall under our definition of 3D printing include all production systems that are dependent on the automatic and computer- managed formation of three- dimensional objects in one or more starting materials, either liquid or solid, through an additive process dependent on solidification.

Presently there are many ways of melting or treatment the material to produce the levels. Whilst the technology has been around for 30 years it's only in the last 5 years, and the rise of desktop computer 3D printers, that individuals have grown to be aware of its game altering potential across all industries.

Additionally it is known as additive production and is altering the way in which we produce and create, but not only in industry.

Innovative designs are being used to build up machine parts, prosthetic limbs, sustainable casing and even three dimensional - printed medications [1].

## **1.1. RESEARCH PROBLEMS**

With the rapid development and spread of 3D printing technology, new materials or additives appear that can have a positive impact on the mechanical properties of printed materials.

In fact, 3D-printed plastics have lower mechanical properties than materials made by other methods such as injection.

Therefore, in this paper, we will study the effect of adding carbon fibres to 3D printing materials (PLA). By adding carbon fibers, it is possible to obtain new properties of 3D-printed materials and thus can be used in new applications.

The unique aspect of this study is that we will study the tensile behavior and fatigue behavior on PLA with Carbon Fifer materials produced by 3D printing technique.

The research problem is to improve the properties of 3D printing materials by adding carbon fibers to PLA in different Rate:

- What is the probability of increasing the mechanical properties of polymeric materials (PLA) by adding carbon fibers to it by 15%?
- What is the probability of increasing the mechanical properties of polymeric materials (PLA) by adding carbon fibers to it by 20%?
- What would be the mechanical properties of PLA without adding carbon fiber to it?

## **1.2. IMPORTANT OF RESEARCH**

This research is one of the few studies that talk about the same topic, in addition to the fact that 3D printing technology is entering advanced industries. That is why the interest in 3D printing technology has increased in both the academic and industrial side. The importance of this research can be elaborated into:

- Academic Importance:
  - The research deals with a central topic related to the effect of additives on 3D printing materials.
  - Scarcity of other research related to our field of research.
  - Study of fatigue behavior on samples of PLA with Carbon fibers, and this type of study is not found in academic references, as there are similar studies for materials other than PLA.
- Practical Importance:
  - Knowing the effect of adding different percentages of carbon fibers to PLA 3D printing materials.
  - Determine the best carbon fiber ratio for both tensile experience and fatigue experience.

### **1.3. RESEARCH OBJECTIVES**

The research mainly aims to:

- Knowing the effect of adding carbon fibers on PLA 3D printing materials.
- Determine the best carbon fiber ratios to withstand tensile stress and fatigue stress.

### **1.4. RESEARCH COMMUNITY AND DELIMITATION**

This research will work to produce 3D printed PLA and PLA with Carbon fiber samples. Tensile and fatigue experiments will be performed on the produced samples. The search will be carried out according to the following Delimitation:

**Spatial Delimitation:** The samples will be printed in Istanbul using “Ender3 3D printer”. Ender3 printer is manufactured by the Chinese company called Creality. This printer works according to FDM technology.

As for the tensile and fatigue tests, they will be carried out in the engineering laboratories of Karabük University, under the supervision of the academic engineering staff.

**Temporal Delimitation:** Work on the master's thesis began in October 2021, and completed in August.

## **1.5. RESEARCH PROCEDURE**

In order to achieve the objectives of the research, the researcher uses the descriptive experimental method which is defined as a system of scientific investigation, it is usually based on a design to be carried out under controlled special conditions, which is intended to test a hypothesis and establish a causal relationship. So the work was divided into the following:

**Theoretical part:** First, work will be done here to study the research problem and study a literature review of the academic literature related to the subject of the research. The necessary information will be collected to cover the theoretical side by accreditation and reference to various documents such as books, newspapers, scientific journals and other materials that prove their validity with the aim of analyzing them to reach the objectives of the study.

**Practical part:** here will be working on the production of samples according to the specified engineering parameters, and then conducting practical experiments and recording the results of experiments, processing and analyzing them in order to reach the final results of the research.

## **1.6. DEFINITIONS**

**3D Printing Technology:** means creating models and objects from scratch. That is, without wasting parts of the material. It is also called rapid prototyping or Additive manufacturing technology. The process works by laying down thin layers of material in the form of liquid or powdered plastic, metal or cement, and then fusing the layers

together. The basic principle of this technology is that a model, initially generated using a three-dimensional Computer-Aided Design (3D CAD) system, can be fabricated directly without the need for process planning [2].

**Fused Deposition Modeling FDM:** It is the technique of applying a molten polymer, pressing it through a nozzle, and layer-by-layer deposition on a printing layer and on the previous layers, respectively. That means each layer is laid down one at a time until the part is complete [3].

**Infill Designs:** Infill or filling is one of the maximum critical variables while 3d printing an element, this time period refers back to the internal structure printed interior of an item. Its density, styles & orientation are all elements comprising how a part is made up effecting its strength and functionality. It determines how reliable & efficient it's far to print flat, horizontal faces over an empty space [4].

**Polylactic Acid (PLA):** This material is the most prevalent and most widely used material for 3D printing due to its important features being odorless and safe to use. This material is environmentally friendly because it is made from annually renewable resource which is cornstarch) the sugar in these renewable materials are fermented and turned into lactic acid, when is then made into polylactic acid, or PLA (it also requires less energy for processing, available in a variety of colors) [5].

**Fatigue Testing:** It is a test to which a material is subjected. Material fatigue is a process of structural change that occurs to it and can lead to cracks or complete fracture of the sample after a number of changes. The sample can return to its initial state if the maximum pressure applied to it does not exceed the elastic limit of the material itself, and the load on the sample can be repeated several times. Cyclic fatigue tests produce repeated loading and unloading in tension, compression, bending, torsion or combinations of these stresses [6].

## PART 2

### THEORETICAL BACKGROUND

#### 2.1. INTRODUCTION

3D printing is a modern technology based on AM: Additive Manufacturing to obtain complex three-dimensional geometric designs and models using CAD program and save it in STL format and convert it to the printing program that defines all printing variables, The layers are to be built one layer on top of the other until obtaining the final model as shown in Figure 2.1. [7].



Figure 2.1. Build layers one on top of the other [29].

Three-dimensional printing was developed by Charles Hull in the year 1986 in a process called lithography (Stereolithography), and after that printing developed and a layer of powder material was melted and the required model was formed, after that a new technology appeared which is FDM: Fused Deposition Modeling, which is the formation by molten deposition, where the material in the form of threads with a diameter of 1.75 mm is melted and extruded by a jet and built layer by layer [8].

In recent years, 3D printing has developed greatly in terms of technologies and materials and has the ability to manufacture complex geometric shapes in much less time than traditional manufacturing methods, in addition to the ability to manufacture products in small quantities at a relatively low cost.

3D printing has been widely used in various industries, where an entire building with its furniture was built using 3D printing, and this technology was also used to produce prototypes when developing products and expanding its use with the development of its materials to be used in building space equipment and missiles. As a result, the demand for the use of 3D printing techniques has increased for several reasons, including the ease of design modification, implementation of the design no matter how complex, production automation, reducing the amount of material waste, reducing the cost and time of production in addition to the low price of printers compared to other machines. Programmed operation [7,8].



Figure 2.2. Building in the UAE built using 3D printing [30].

## 2.2. BASIC STAGES OF 3D PRINTING

Printing is carried out according to the following stages:

- Design the model to be printed using one of the CAD programs and save the file in STL format.
- The STL file is transferred to a printing program such as CURA to determine the position of the piece, the type of material, the degree of heating temperature, the proportion and shape of the filling pattern, and all information is transferred to G-Code.

The G-Code file is copied to a memory card.

The printer is turned on and prepared the file is copied from the memory card to the printer.

- After completing the printing of the form, it is removed from the printer, finishing operations are performed and the supporting materials are removed [9].

## **2.3. THREE D PRINTING TECHNIQUES**

There are a large number of 3D printers available in the market of 3D printers with different dimensions and technologies. Choosing the type of printer and the technology used is an important matter that must take into account many factors such as noise level, technical specifications, production standards, and occupational safety procedures, Therefore, it is necessary to determine what is required to be manufactured by the printer before choosing the type of printer, and whether we need quantitative production, what materials are required to be used to print models, and what are the dimensions of the products [7].

### **2.3.1. Powder Bed Fusion**

#### **2.3.1.1. SLS: Selective Laser Sintering**

This technique uses the powder (powder) of the material, a quantity of the powder is placed on the workbench of the printer and this layer is sintered according to the

three-dimensional digital model. The problem is with noticing the high level of the powder tank every time and so on layer by layer until we get the final product as shown in Figure 2.3., then the piece is cooled and blown using compressed air to remove the suspended powder, layers 0.06mm thick can be produced with precision  $\pm 0.2$  mm [7,10].

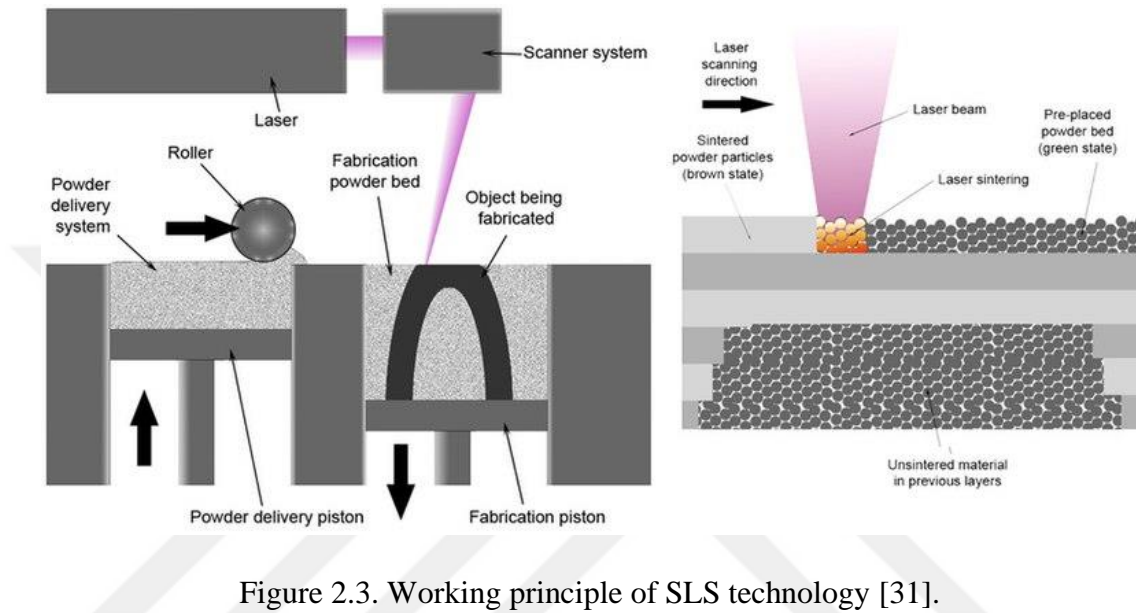

Figure 2.3. Working principle of SLS technology [31].

There are several plastic materials that can be used in SLS technology, such as nylon (Polyamide), polyester and many thermosetting plastics [7]. This technology is used in:

- Manufacture of prototypes for display or test models such as aerodynamic tests.
- Manufacture of custom products (each piece has a different design and dimensions).
- Very complex designs with a lightweight design [7,10].

This technique has the following pros and cons:

Table 2.1. Pros and cons of the SLS method.

<b>Disadvantages</b>	<b>Advantages</b>
Needs finishing	Suitable for plastic parts with fine details
Bending of cutting with large surface layer	No backing material needed to prevent seams from drooping
	good production rate
	Unused powder can be reused

### 2.3.1.2. DMLS: Direct Metal Laser Sintering

The working principle of this technology is similar to that of SLS technology, with the difference that DMLS technology uses powdered metallic materials instead of plastic materials, and layers with a thickness of 0.02mm and an accuracy of  $\pm 0.2$ mm can be produced [7].

Several metallic materials are available in the form of powder, such as nickel-chromium alloy, aluminum powder, stainless steel alloy powder, and titanium powder [11]. This technology has the following pros and cons [10]:

Table 2.2. Pros and cons of the DMLS method.

<b>Disadvantages</b>	<b>Advantages</b>
Requires heat treatment processes to remove heat stresses	High mechanical and thermal properties
Polishing is required for a smooth exterior	Unused powder can be recycled
High laser power causes significant thermal stress	Manufacture of complex parts
Mechanical operations are required to remove the supporting structures	

Noting that sintering is a thermal solidification process to obtain products from powders by heating the powder to a temperature below the melting point, thus sticking the atoms of the material.

### 2.3.1.3. SLM: Selective Laser Melting

This technology is similar to DMLS technology with the important difference that the laser power used is greater so that the powder melts instead of sintering, and therefore each layer that is formed is higher than the temperature of fusing, which is why it must work in an inert atmosphere (containing no oxygen) using an inert gas such as argon or nitrogen [7].

The working principle of this technology is based on the same method as the previous techniques, where the table is lowered after forming the first layer and the powder transfer arm moves to add a new amount of powder and form a new layer and so on until the required product is obtained as shown in Figure 2.4., and upon completion of Production process Excess powder is removed.

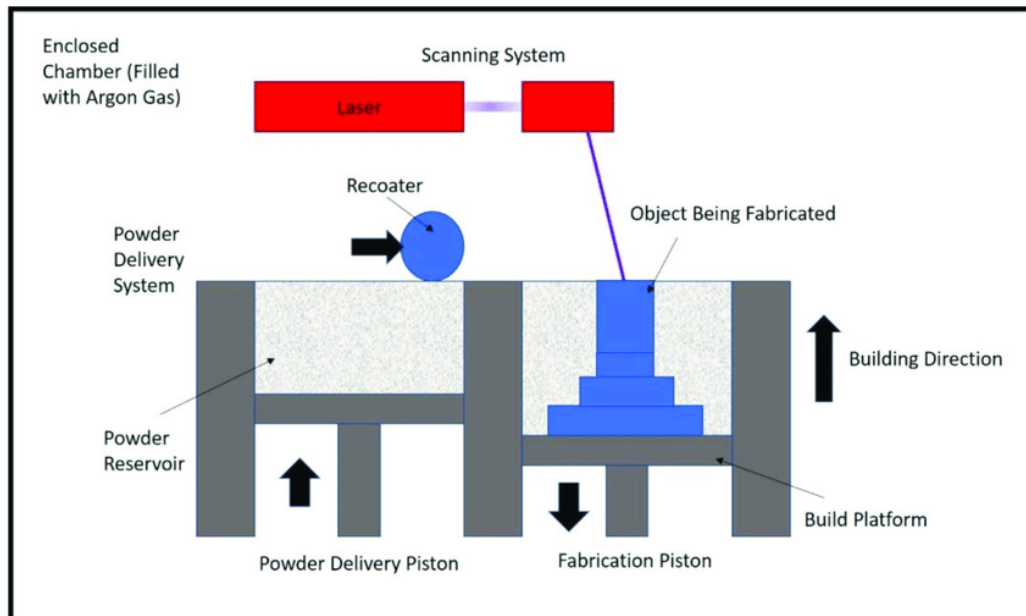

Figure 2.4. Working principle of SLM [32].

This method allows the use of materials with high mechanical properties such as stainless steel, tool steel, titanium, cobalt chromium alloy and nickel alloys, and we obtain products with very high density and durability. It is possible to produce layers with a thickness of 0.02 mm and an accuracy of  $\pm 0.2$  mm [7].

- This technology is used to obtain products with a complex design with very thin walls or contain voids in order to obtain low-weight products, and is used in the fields of aviation, aerospace, auto parts, turbines and metal molds [10], and this technology has the following pros and cons:

Table 2.3. Pros and cons of the SLM method.

<b>Disadvantages</b>	<b>Advantages</b>
Requires heat treatment processes to remove heat stresses	Obtaining parts with high mechanical properties
High laser power causes significant thermal stress	Very high dimensional accuracy
Mechanical operations are required to remove the supporting structures	Very high durability with thin wall thickness

#### **2.3.1.4. EBM: Electron Beam Melting**

This technology is similar to the Selective Laser Melting Technology (SLM) in terms of melting the metal powder particles for each layer until the required design is completed, but this method differs in that it uses an electronic beam with high speeds that collides with the powder particles, which leads to its high temperature and melting, as shown in Figure 2.5. After forming the first layer, the work table is lowered down and a new amount of powder is added, and the process is repeated until the formation of the desired design is completed [7].

This method works in an atmosphere of vacuum in order to avoid the collision of electrons with air molecules, as it needs subsequent treatment processes.

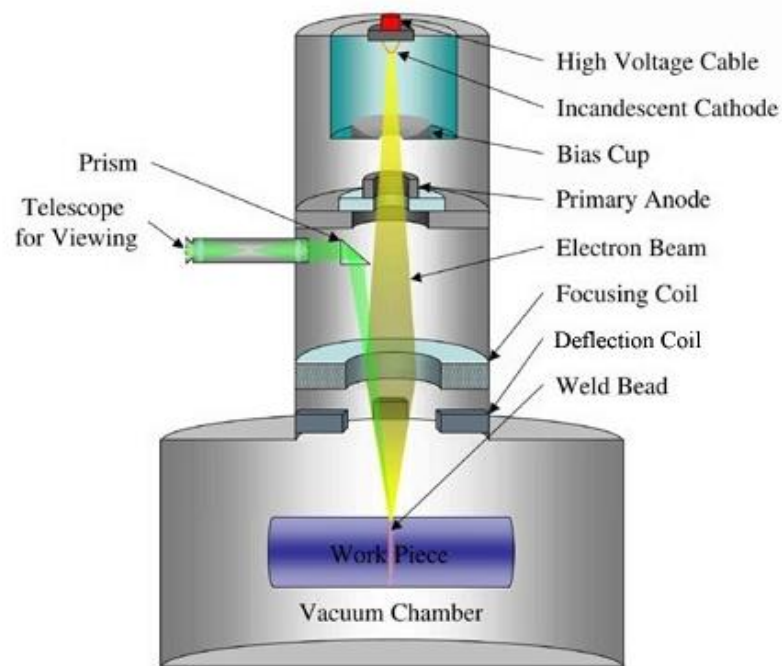

Figure 2.5. EBM Technology Working Principle [33].

This technology is used in

- Printing a limited number of metals, often using titanium alloy, aluminum alloy, cobalt, and nickel alloy.
- Manufacture of prototypes for use in functional tests.
- It is used to manufacture custom medical implants that are suitable for each patient.
- It is used to manufacture support pieces in the human body, joints, and stabilizers in surgical operations [10].

This technology has the following pros and cons:

Table 2.4. Pros and cons of the EBM method.

<b>Disadvantages</b>	<b>Advantages</b>
Subsequent operations to remove thermal stresses	High mechanical properties
Mechanical operations to remove the supporting parts	High density metal parts
Lower production rate than SLM	Energy consumption is lower than SLM



Figure 2.6. Skull Brace made by EBM metode [34].

#### **2.3.1.5. MJF: Multi JET Fusion**

This technique differs from previous techniques, a substance called melting agent is added to the powder layer, a quantity of powder is spread on the work table and a melting agent substance is added according to the engineering design of each layer, this substance absorbs heat energy that is applied using ray lamps Infrared, which leads to the melting of the powder according to the required shape as shown in Figure 2.7., and this process is repeated for each layer until the completion of manufacturing the required design, layers with a thickness of 0.07 mm and an accuracy of  $\pm 0.2$  mm can be produced [7].

This method is faster than the previous methods because a complete layer is formed at the same moment instead of waiting for the layer to form through the passage of the laser or electron beam according to the design.

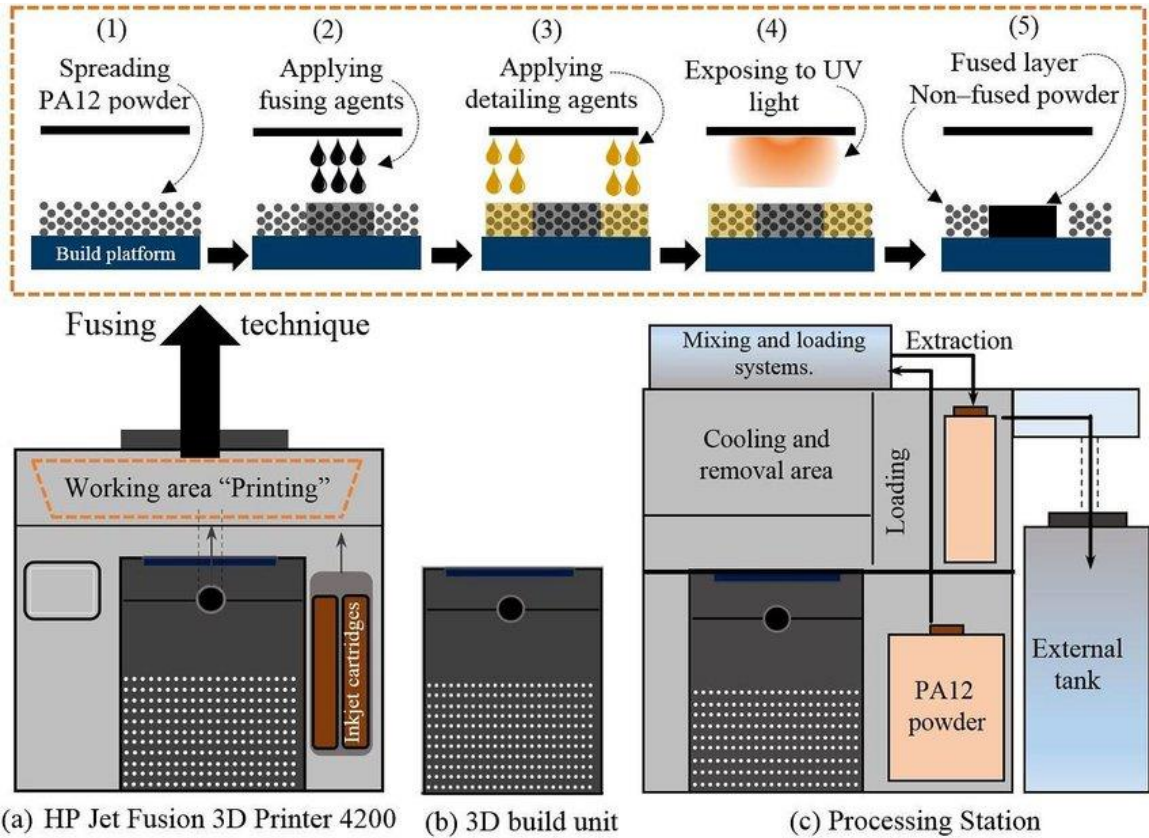

Figure 2.7. working principle of the MJF method [35].

This technique has the following pros and cons:

Table 2.5. Pros and cons of the MJF method.

Disadvantages	Advantages
Currently, only nylon is used	High mechanical properties
Pieces produced with this technique are only black in color	Good surface finish quality
You need a complex cooling system	Low production time

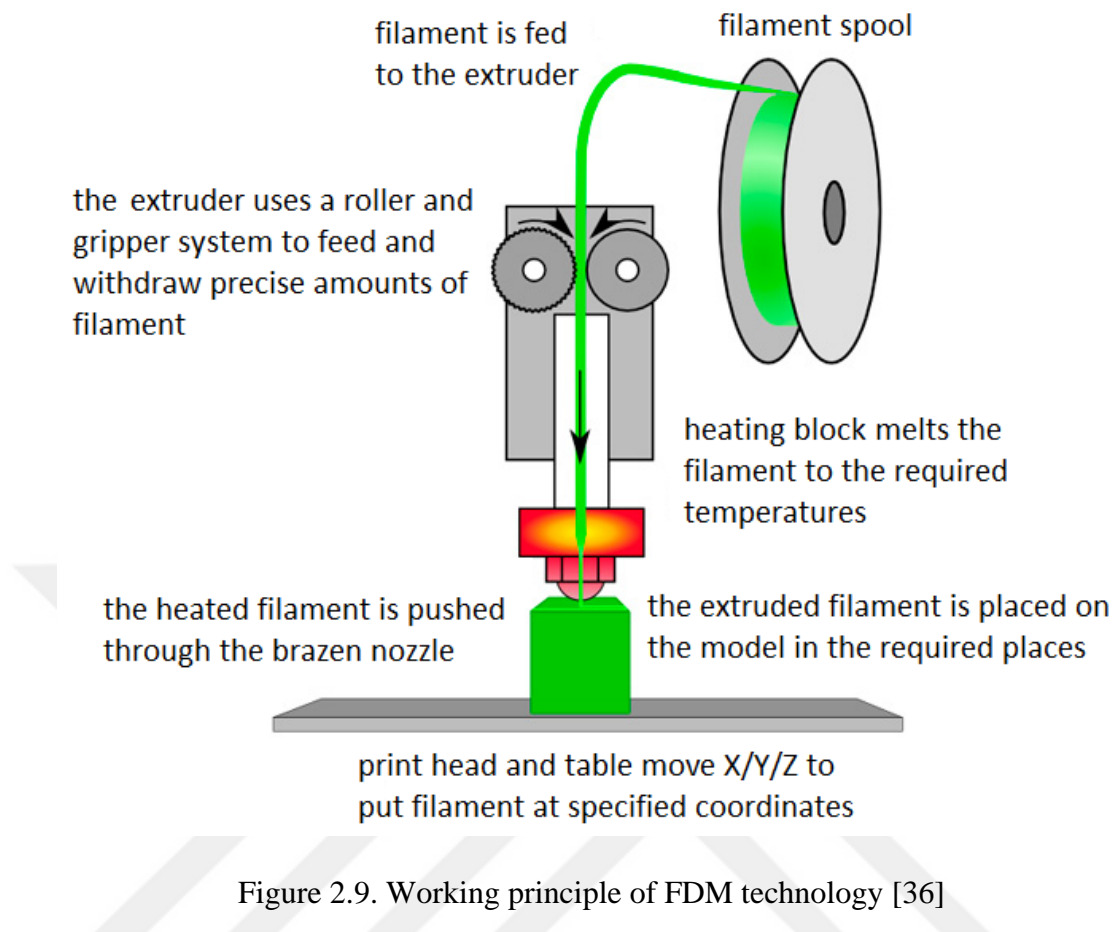

Figure 2.8. Hand piece made with MJF technology.

### **2.3.2. FDM: Fused Deposition Modeling**

In this technology, the plastic filaments are melted and extruded through a nozzle of different diameters, and the design is built one layer over the other until the design is completed. The plastic filaments are melted by heaters surrounding the duct of the filaments as shown in Figure 2.9., there are different designs for these printers, The printer head can move in two directions (X,Y) and the table can move in the direction of the (Z) axis or the head can move in the direction of the (Z) axis. In addition to its movement in both directions (X,Y), it is possible to produce layers with a thickness of 0.178 mm and an accuracy of  $\pm 0.15$  mm [7].

This technology is mainly used for plastic materials such as ABS: acrylonitrile butadiene styrene. PLA: Polylactic Acid, PC: Polycarbonate, PA: Polyamide, PS: Polystyrene These materials offer various mechanical and thermal properties as well as a wide range of colors [12,13].



This technology is used to print rapid and low-cost prototypes to test the fit of the shape and design. This technology is considered the most prevalent 3D printing technology due to the low price of its printers and materials [7], and this technology has the following pros and cons:

Table 2.6. Pros and cons of the FDM method.

Disadvantages	Advantages
True asymmetric mechanical properties	Simple 3D printing technology
Low cohesion of the layers on the (Z) axis.	Low prices for printers
	A wide range of materials achieve different mechanical properties
	Low prices for materials used with this technology



Figure 2.10. Prosthetic limb made using FDM technology.

### **2.3.3. DED: Direct Energy Deposition**

#### **2.3.3.1. LENS: Laser Engineered Net Shape**

This method is used to manufacture metal parts by direct deposition of molten metal powder by a high-energy laser beam, which causes the powder to melt and exit from the extrusion nozzle either due to gravity or through pressurized gas, the laser beam is focused through the center of the supply head surrounded by several nozzles tilted at an angle suitable for supplying the powder towards the center as shown in Figure 2.11., the head moves on the two axes (X,Y) until the first layer is completed and then the head moves towards the z-axis (Z) to form the next layer, this method is done under a controlled atmosphere by inert gas (Argon) In order to prevent the presence of oxygen that reduces the quality of the adhesion of the layers, it is possible to produce layers with a thickness of 0.025 mm and an accuracy of  $\pm 0.25$  mm [7].

This technology uses a variety of materials in the form of powders such as stainless steel alloys, tool steels, nickel-cobalt alloys and titanium, and we obtain products with high mechanical and thermal properties [7,11].

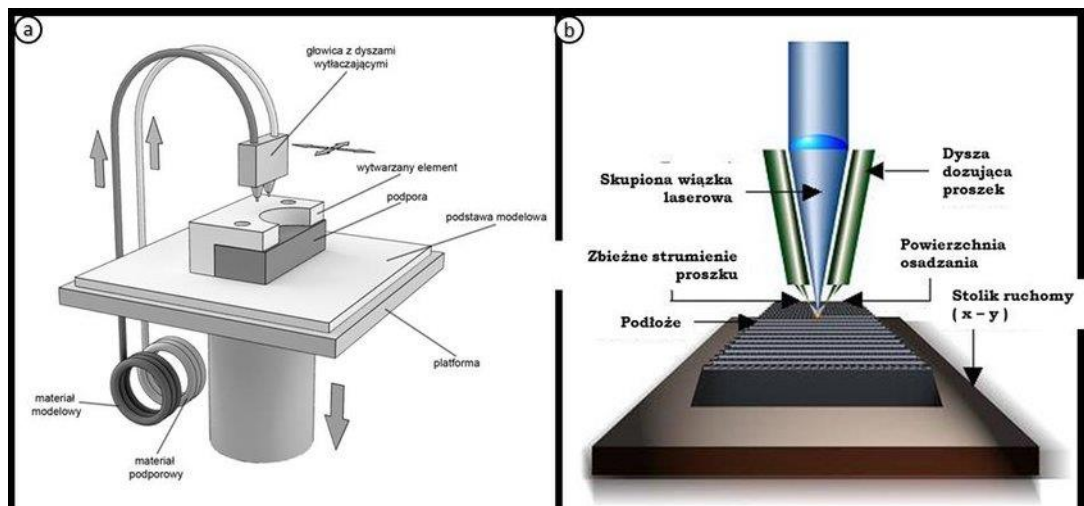

Figure 2.11. Working principle of the LENS method [37].

### This Technique is Used in

Replacing defective components by manufacturing replacement parts, rapid prototyping for testing.

Manufacturing in the aviation, space and military sectors. This technology has the following pros and cons [10]:

Table 2.7. Pros and cons of the DED method.

Disadvantages	Advantages
Bad surface finish	The possibility of manufacturing large parts
	Manufacture of very complex shapes
	The best printing techniques to replace damaged parts in machines

### 2.3.3.2. EBAM: Electron Beam Additive Manufacturing

This technique is similar to the previous technique, with a fundamental difference, as this technique uses a metal wire instead of metal powder, the metal wire is exposed to an electronic beam emitted by an electronic gun, which leads to the melting of the

metal wire and the formation of the required layer according to the engineering design as shown in Figure 2.12, the process takes place in a vacuum so that the parts produced are not affected by oxygen. Double feeding can be used by adding another wire of another material, which allows obtaining different metal alloys in one piece. It is possible to produce layers with a thickness of 0.1 mm and an accuracy of  $\pm 0.05$  mm [7].

The materials available for this method are: stainless steel, copper alloy, nickel alloy, titanium alloy and tantalum (Tantalum) [11].

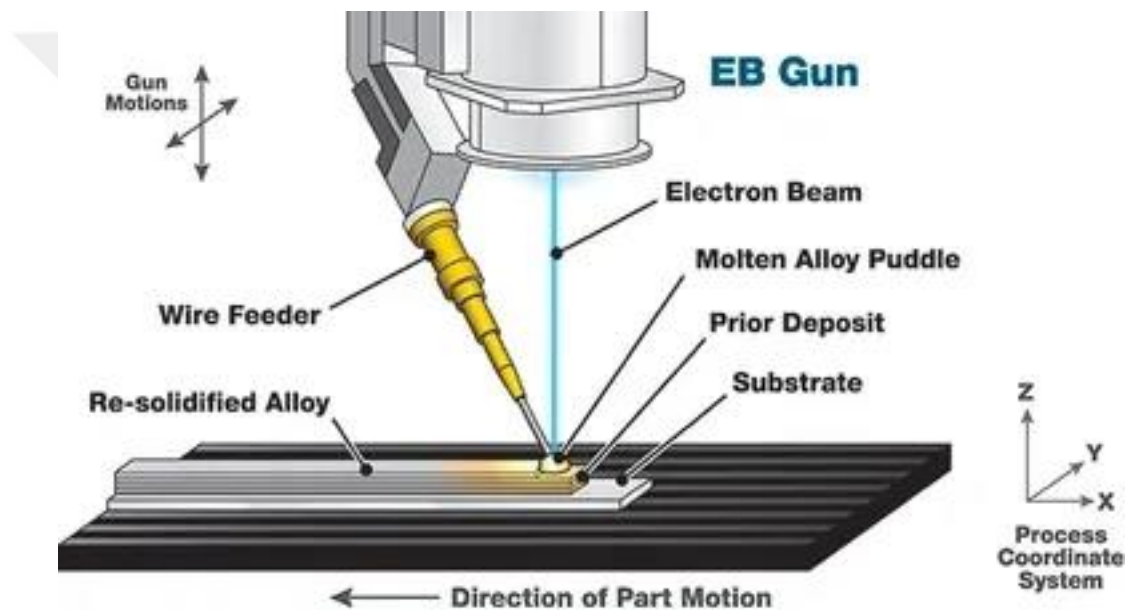

Figure 2.12. EBAM Technology Working Principle [38].

### **This Technique is Used in**

Production of rapid prototyping as this method is faster than the methods that use powder.

It is used for parts that require very high mechanical properties [10], and this technique has the following pros and cons:

Table 2.8. Pros and cons of the EBAM method.

Disadvantages	Advantages
Bad surface finish	high print speed
	Very high mechanical properties
	The possibility of combining alloys in one piece

### 2.3.4. Vat Photopolymerization

#### 2.3.4.1. SLA: Stereolithography

This technique uses a special resin (resin), the printer trough is filled with liquid resin, and the laser causes the chains of molecules to link together, forming solid polymers, to get the first layer of the three-dimensional product as shown in Figure 2.13., after which the table is either lowered or its height, according to the design of the printer according to the thickness of the layer, and the process is repeated until the completion of the formation of the required pattern, it is possible to produce layers with a thickness of 0.025 mm and an accuracy of  $\pm 0.15$  mm [7].

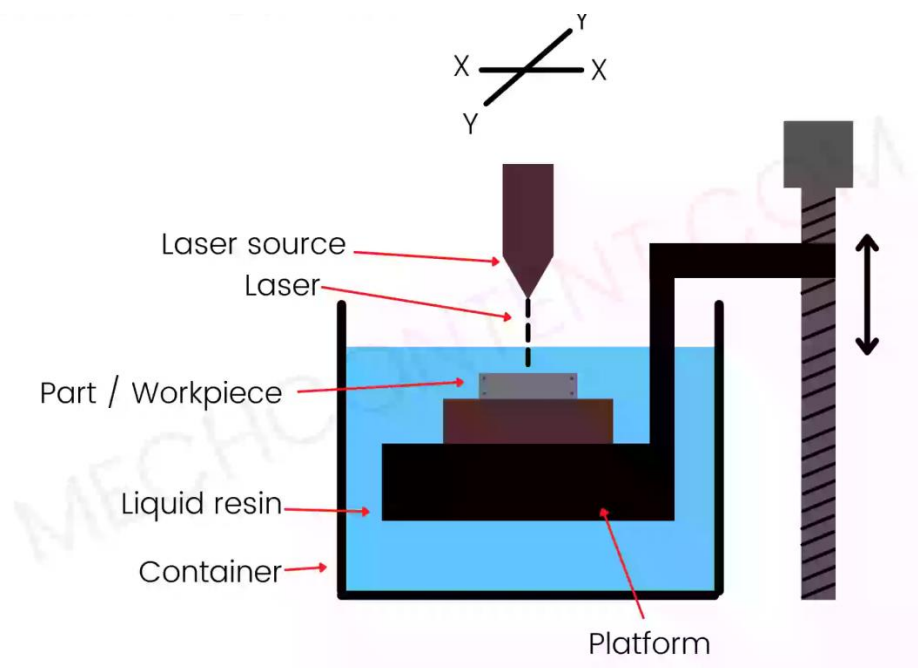

Figure 2.13. Working principle of the SLA method [39].

### **This Technique is Used in**

- The medical field and in the prosthodontics industry.
- Manufacture of small scale models with very accurate details.
- Casting and wasted wax casting operations.
- Jewelry manufacturing [10].

This technology has the following pros and cons:

Table 2.9. Pros and cons of the SLA method.

<b>Disadvantages</b>	<b>Advantages</b>
The material used is very sensitive to light	very high accuracy
Low mechanical properties	Printing very intricate shapes
The high price of resin	Ease of removal of the supporting parts

#### **2.3.4.2. Digital Light Processing: DLP: Digital Light Processing**

This technology is similar to SLA technology with the difference that the laser beam that forms the layers is replaced by a high-resolution digital screen that produces the layer in one go. To obtain the final product, the model is processed using ultraviolet rays to improve the mechanical properties. It is possible to produce layers with a thickness of 0.05 mm and an accuracy of  $\pm 0.15$  mm [7].

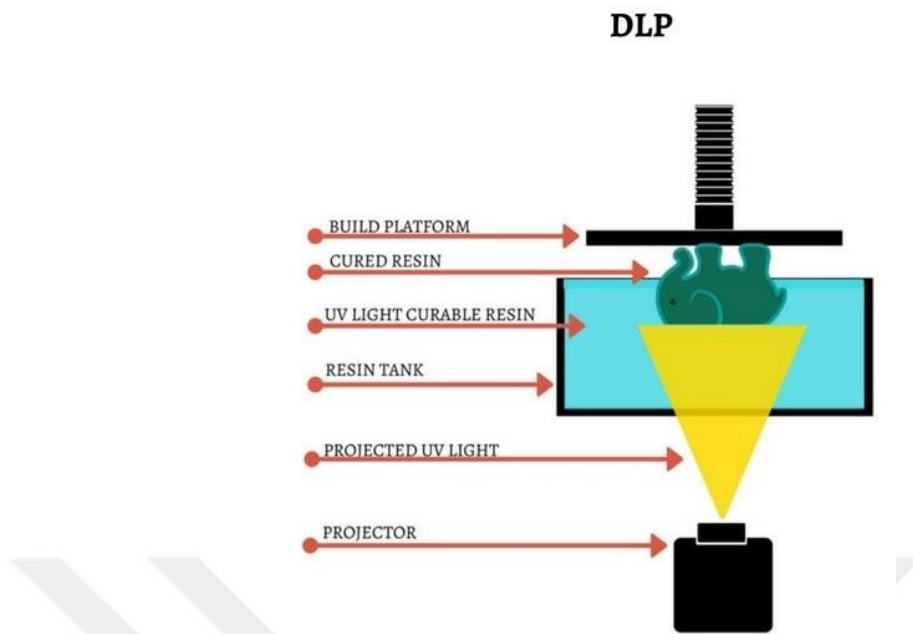

Figure 2.14. Principle of DLP Technology [40].

**This Technology is Used in**

- Manufacture of small and very complex models.
- In casting, wasted wax casting and jewelry manufacturing.
- Casting models [10].

This technology has the following pros and cons:

Table 2.10. Pros and cons of the DLP method.

<b>Disadvantages</b>	<b>Advantages</b>
The material used is very sensitive to light	very high speed
Low mechanical properties	Printing very intricate shapes
The high price of resin	Very high productivity

## 2.4. PRINTING MATERIALS

The great development of 3D printing technologies has been accompanied by the development of materials used in printing, as a wide range of materials are available such as polymers, metals, ceramics, composites and powders, as shown in Figure 2.15.



Figure 2.15. Various types of printing materials.

### 2.4.1. Plastic Materials

A large number of plastic materials are available that differ in mechanical, thermal and color properties. The plastics are used in FDM technology, where they are in the form of filaments wrapped on a spool with diameters of either 1.75 mm or 3 mm [13].

PLA: Poly Lactic Acid It is the most used material in 3D printing, it can be recycled and is biodegradable and therefore is an environmentally friendly material [11], and this material has the following pros and cons [13]:

Table 2.11. Pros and cons of the PLA material.

<b>Disadvantages</b>	<b>Advantages</b>
Deforms at relatively low temperatures 60°	Extrusion at a relatively low temperature (210 °)
Moisture absorption from the air	Achieve good durability and high surface quality
	You do not need to heat the workbench to a high temperature
	Available in multiple colors
	Environmentally friendly
	Easy to print at high speed
	Possibility of perforation after printing is completed

#### 2.4.1.1. ABS: Acrylonitrile Butadiene Styrene

This material is used to print parts that are subjected to mechanical shock, as it has a high impact resistance compared to PLA material [14]. This article has the following pros and cons [8]:

Table 2.12. Pros and cons of the ABS material.

<b>Disadvantages</b>	<b>Advantages</b>
Mechanical properties change when exposed to ultraviolet rays	High hardness and durability
Moisture absorption from the air	Easy to process and paint
High temperature printed	Maintains product shape up to 100°C
And you need to heat the workbench to a high temperature	The possibility of gluing the pieces together using acetone
	A wide range of colors

#### 2.4.1.2. PET: Poly Ethylene Terephthalate

It is a polymer of the polyester family, and it is a transparent material used in many areas, the most important of which are food utensils and water bottles, and this material has the following pros and cons [8,13]:

Table 2.13. Pros and cons of the PET material.

<b>Disadvantages</b>	<b>Advantages</b>
Medium heat resistance	Soft and smooth look
Color change during printing	Moisture resistant
It becomes pounded in case of printing at high temperature	Recyclable
	High shock durability
	Can be used for utensils

#### 2.4.1.3. PETG: Poly Ethylene Terephthalate Glycol

The addition of Glycol improves the durability and heat resistance of PET, and this material has the following pros and cons [12,13]:

Table 2.14. Pros and cons of the PETG material.

<b>Disadvantages</b>	<b>Advantages</b>
UV sensitive	Smooth and consistent surface
Color change during printing	Moisture resistant
	Recyclable material
	Good resistance to heat and pressure

#### 2.4.1.4. TPU: Thermo Plastic Polyurethane

It is a rubber-like material used in printing to produce semi-elastic parts. This material has the following pros and cons [8,13,14]:

Table 2.15. Pros and cons of the TPU material.

<b>Disadvantages</b>	<b>Advantages</b>
Cannot be pasted with other pieces	Good corrosion resistance
	Flexible material, oil and grease resistant
	flexible material
	low shrinkage

#### 2.4.1.5. Nylon (Polyamide)

It is a versatile material where it is flexible if the piece is thin, but when it is printed in large thicknesses, we get very high mechanical properties. This material has the following pros and cons [8,12,13]:

Table 2.16. Pros and cons of the NYLON material.

<b>Disadvantages</b>	<b>Advantages</b>
smooth surface	high durability
Outgassing during printing	High wear resistance
Too craving for moisture	Excellent alternative to ABS
Difficult to print due to its flexibility	It can be flexible in case of thin thicknesses

#### 2.4.1.6. PC: Polycarbonate

It is a material with a very high durability due to the presence of carbon in it, and it can be used in medical applications (prosthetic limbs), aircraft, construction, electronics and glasses. This material has the following pros and cons [8,13]:

Table 2.17. Pros and cons of the PC material.

<b>Disadvantages</b>	<b>Advantages</b>
Very sensitive to UV rays	high durability
Printing temperature is high	High heat resistance
Too craving for moisture	Easier to print than ABS
	can be sterilized

## 2.5. INFILL PATTERN

It is a structure with a specific shape made of the same material or of a different material inside the piece manufactured by 3D printing. It can be simple lines or very complex geometric shapes as shown in Figure 2.16., and it greatly affects the durability of the design, the weight of the product and the time of printing [15].

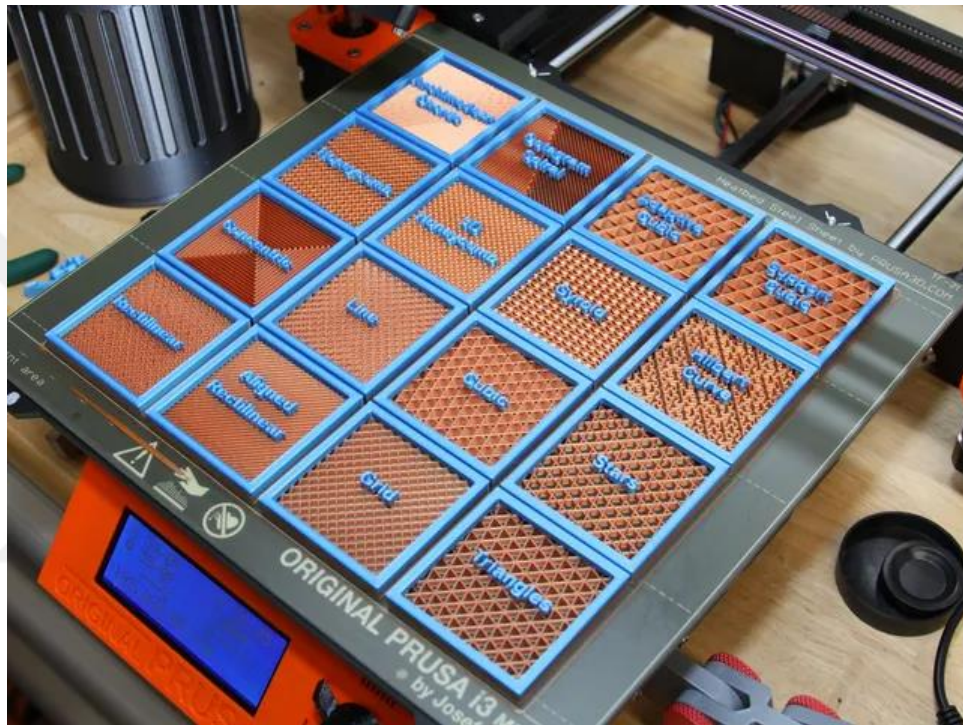

Figure 2.16. Some forms of filling patterns.

3D printing allows control of the design by controlling the thickness of the wall and the density and shape of the filling pattern in thick places, whatever the thickness of the piece and the geometry of the filling pattern. To which it is subjected [15,16].

The development of software used in 3D printing allowed determining the shape and density of the filling pattern using programs that convert designs into layers such as Cura, which contains 13 selectable infill patterns, or Simplify3D, which contains only 6 patterns.

### 2.5.1. Infill Patterns Types

- Lines

This pattern is lines that are printed in one direction either in the direction of X or in the direction of Y layer by layer until the completion of the design, this pattern is characterized by the speed of completion of printing and is used when high durability and low weight is required, used for prototyping and is not suitable for subsequent operations such as perforation.

The Infill Pattern used in this research is of type Lines.

- Grid:  
This pattern is similar to the previous pattern but differs from it that the lines are not unidirectional but rather form lines on the X direction and lines on the Y direction in each layer. This style consumes more materials and time, but the durability is better.
- Triangle:  
This pattern resembles intertwined triangle lines with lines running in three directions in the XY plane and is used for designs that require high strength and are subject to loads and lateral stresses.
- Tri-Hexagon:  
It is a pattern that contains a set of lines running in three directions in the XY plane creating hexagonal patterns with triangles, suitable for designs that need high durability.
- Cubic:  
This pattern produces stacked blocks but due to their 45 degree inclinations about the X,Y axes they look like triangles. This pattern offers excellent durability but requires more time and material.
- Octet:  
This pattern is similar to the Cubic, but produces pyramid shapes by printing squares from large to small, this pattern gives very high durability and is very suitable for designs that are exposed to vertical loads.

- **Quarter Cubic:**  
This style builds multiple squares to form pyramids within the piece with deflectors of the pyramids to create connection points, giving this style the highest durability possible.
- **Concentric:** This style is concentric circle lines of increasing diameter, used when good flexibility and low toughness are required.
- **Zig-Zag:** This pattern produces solid lines in all directions and is similar to Lines pattern but gives better durability.
- **Cross:** We get this style of changing the angle of the lines 45 degrees and 90 degrees so as to create a flexible part which is suitable for flexible designs and does not need high durability.
- **3D Cross:** It is similar to the previous pattern and gives better flexibility.
- **Gyrod:** It is a multi-wave printed inside the design and by using it we get a very flexible part with good durability but it needs a long time to print.
- **Cubic Subdivision:**  
Dividing the cube into different sizes, it uses less Cubic-pattern materials and is suitable for designs that require post-processing such as drilling [16,17].

## **2.6. INFILL DENSITY**

The infill density defines the amount of material that used on the inside of the sample printed. Experiments and studies indicate that a higher infill density means that there is more material on the inside of your printed sample, leading to a tougher object. An infill density around 20% is employed for models with an image purpose, higher densities can be used for ending- use parts.

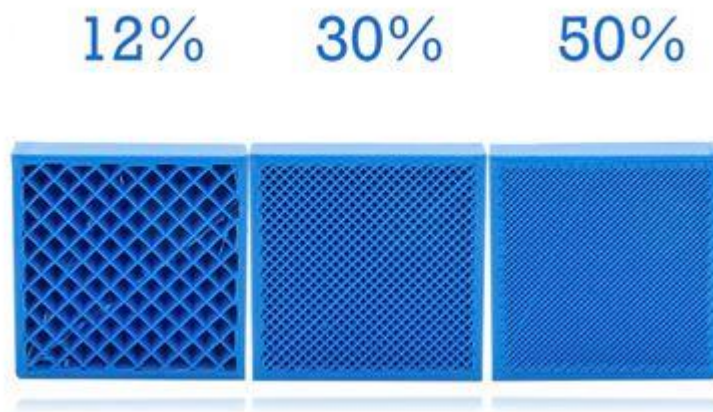

Figure 2.17. Different proportions of infill density.

In this research, both 70% and 100% infill density were used.

## 2.7. INTRODUCTIONS TO FATIGUE TEST

All materials, without exception, show off some structure of weakening after lengthy intervals of area use. This weakening is acknowledged as “fatigue” in the material sciences and is of awesome significance to material manufacturers. For example, producers can also use this fatigue conduct know-how when deciding their advertising promotions, product pricing and differentiation as properly as warranties. It may additionally assist producers enhance upon present merchandise or even permit for the improvement of new offerings. Accelerated exams are frequently used to gather statistics indispensable to determine material fatigue.

The most frequent structure of fatigue checking out is recognized as regular amplitude fatigue testing. In this shape of testing, a pattern of material is both stretched or compressed to a most stress and then cycled between that stress and a decrease degree of stress till failure is achieved.

A vital category of substances is polymer composites, which are made from polymers or mixtures of polymers with different materials. Polymer composites have end up extra not unusual as they are greater light-weight than homogeneous metals

and alloys but nevertheless continue endurance, a property that makes them greater strength efficient.

As a result, polymer composites have turn out to be key aspects in countless giant industries associated to strength consumption, inclusive of transportation manufacturing and choice strength production. Acquiring know-how of polymer composite fatigue requires ideal experimentation, which affords possibilities and challenges for make test of plan.

The majority of checking out carried out in this subject is in accordance with the requirements furnished in ASTM E739 (2010) for checking out and evaluation of polymer composite fatigue. All of the take a look at plans mentioned inside this fashionable are of a balanced nature with equal replication and spacing of the samples.

A key attribute frequently used in placing requirements for and evaluation of fatigue conduct is a unique factor of the material's lifetime distribution. For example, a producer can also desire to be assured that 95% of its substances will final for 5 million cycles at a sure stress level. Thus, it is necessary for producers to be capable to estimate this [18].

## **2.8. DEFINITION OF FATIGUE**

Fatigue is the process of progressive long term structural change happening in a materials which is exposed to conditions that produce fluctuating tensions and strains at some time and that may turn in splits or complete break after a sufficient number of variances. When the maximum stress in the example of beauty will not exceed the elastic limit of the respective materials the specimen earnings to its preliminary condition when the load is removed.

A given launching may be repetitive many times provided that the tensions remain in the elastic range. These types of conclusions are proper for loadings repetitive even a

few more times. Nevertheless, it is far from correct when loadings are repetitive thousands or hundreds of thousands of times.

Within such cases break will occur at a stress much lower than stationary breaking strength and this phenomenon is called fatigue [19].

## **2.9. PURPOSE OF FATIGUE TEST**

A new fatigue test helps determine a material's ability to tolerate cyclic fatigue reloading conditions. By design, a material is selected to meet or exceed service loads that are anticipated in exhaustion testing applications. Cyclic fatigue tests produce repeated loading and unloading in stress, compression, bending, torsion or combinations of such stresses. Fatigue checks are commonly filled in tension–tension, compression–compression and stress into compression and reverse.

Typically the objective of an exhaustion test is to determine the life- span that may be expected from your substance subjected to cyclic loading, however exhaustion strength and split resistance are commonly sought values as well. The exhaustion life of a material is the total number of cycles that a material can be subjected to under a single reloading scheme. An exhaustion test is also used for the determination of the maximum load which a sample can tolerate for a specific amount of cycles. Just about all of these characteristics are extremely important in different industry where a material is subject to rising and falling rather than regular makes.

## **2.10. FATIGUE ANALYSIS**

To perform a fatigue, test an example is filled into a exhaustion tester or exhaustion test machine and loaded using the pre- identified test stress, then unloaded to either zero load or an opposite fill. This cycle of loading and unloading can now be repeated until the conclusion of the test is reached. The test may be run to a before-determined amount of cycles or until the trial is unsuccessful according to the parameters of the test.

Fatigue can be triggered by previous perceived stress which can lead to impairment of performance and performance. The particular purpose of the study was proceeding to investigate the relationship between exhaustion and perceived stress [20].



## **PART 3**

### **LITERATURE REVIEW**

#### **3.1. FIRST STUDY ENTITLED**

Characterization of carbon fiber reinforced PLA composites manufactured by fused deposition modeling [21].

This study aimed to compare the tensile mechanical properties of PLA and carbon fiber reinforced PLA.

#### **Results**

The results showed an increase in the tensile strength of the carbon fiber-reinforced PLA samples compared to the pure PLA samples.

The results showed a significant convergence in the tensile behavior between the pure PLA sample and the PLA sample reinforced with 20% short carbon fiber.

While the tensile samples with long fibers achieved a significant increase in the tensile behavior of 6 times compared to the pure polymeric samples.

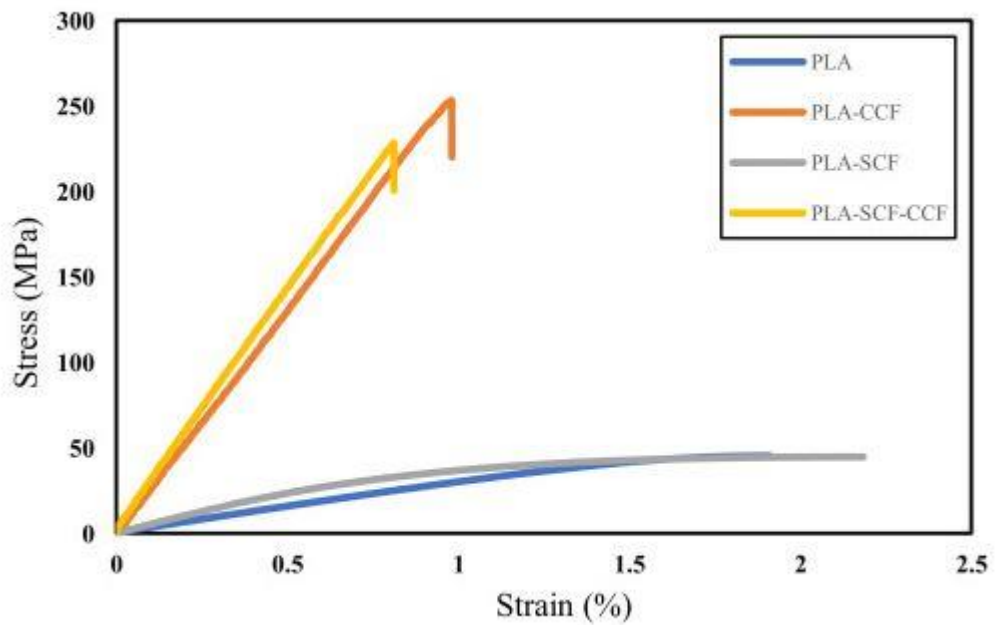

Figure 3. 1. Results of first reference study [21].

### 3.2. SECOND STUDY ENTITLED

Mechanical and Thermo-mechanical Properties of Carbon fiber Reinforced Thermoplastic Composite Fabricated Using Fused Deposition Modeling Method [22].

The study showed that 12% tensile fiber reinforced samples had a slight increase in tensile strength compared to pure polymer. With carbon fiber increased to 15%, the tensile strength was further increased to 32% compared to pure polymer.

While the tensile strength decreased when we increased the carbon content to 20%.

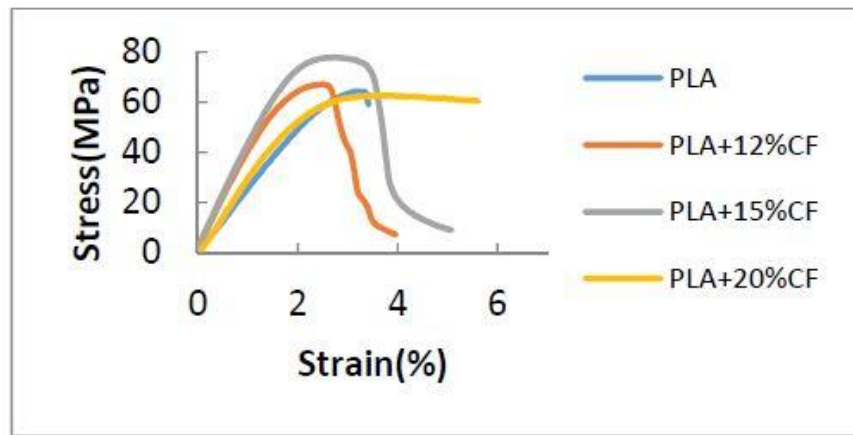

Figure 3.2. Results of second reference study [22].

### 3.3. THIRD STUDY ENTITLED

Mechanical Properties of 3D-Printing Polylactic Acid Parts subjected to Bending Stress and Fatigue Testing [23].

In this study, fatigue behaviour was compared between PLA samples with different layer heights. A fatigue-type experiment was used: Rotating Bending Fatigue Test.

The results showed a high convergence between the pla samples with layer height of 0.1 mm, and the pla samples with layer height of 0.3 mm.

The result of the study came to that it could not be ensured that layer height improves fatigue life.

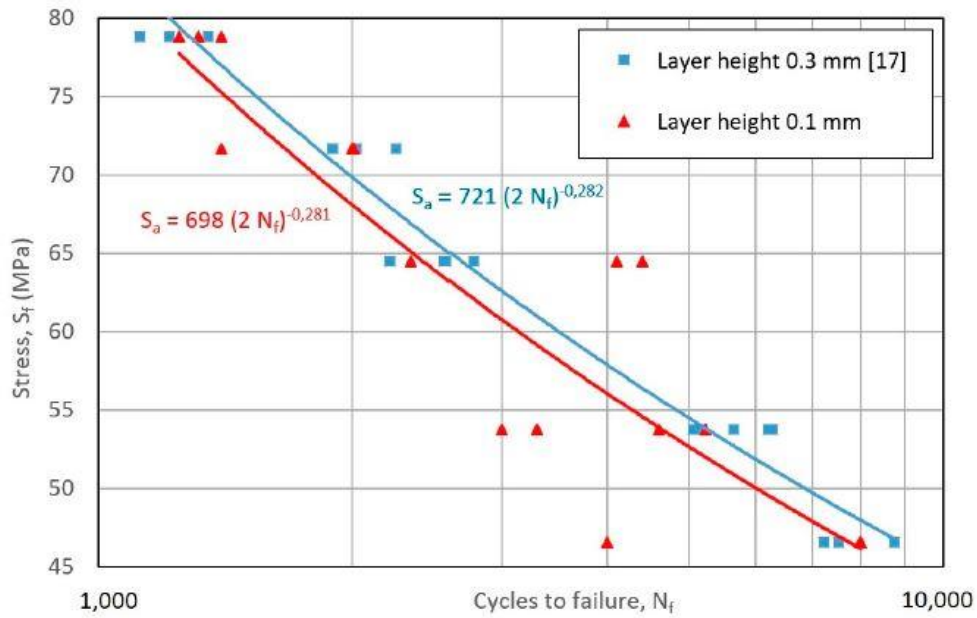

Figure 3.3. Results of third reference study [23].

### 3.4. FOURTH STUDY ENTITLED

A Comparative Study for High-Cycle Bending Fatigue Lifetime and Fracture Behaviour of Extruded and Additive-Manufactured 3D-Printed Acrylonitrile Butadiene Styrene Polymers [24].

In this study, fatigue behavior was compared between extruded ABS samples and 3D printed ABS samples.

A fatigue-type experiment was conducted: high-cycle bending stress.

The results showed better behavior of extruded ABS samples compared to those printed using 3D printing technology.

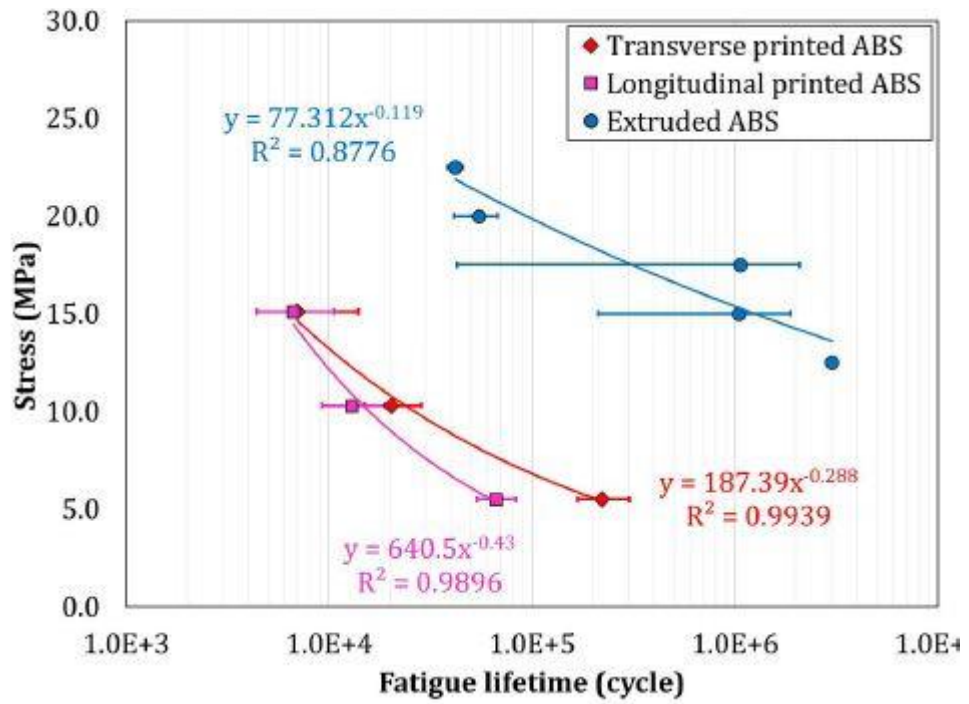

Figure 3.4. Results of fourth reference study [24].

## PART 4

### METHODOLOGY

#### 4.1. MATERIALS AND DESIGN

The tensile fatigue samples were prepared from:

- Pure PLA (With 0% carbon fiber).
- PLA reinforced with 15% short carbon fiber.
- PLA reinforced with 20% short carbon fiber.

Through the use of these materials, the tensile and fatigue samples were designed on the Solidworks program according to specific measurements.

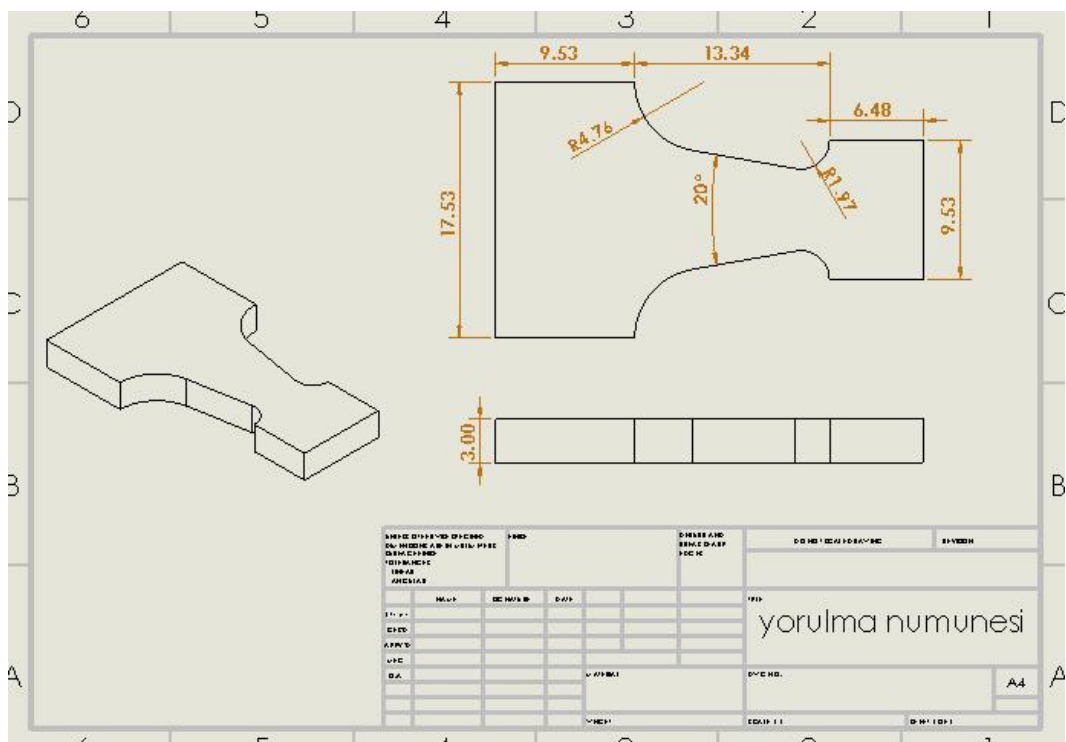

Figure 4.1. Fatigue test design.

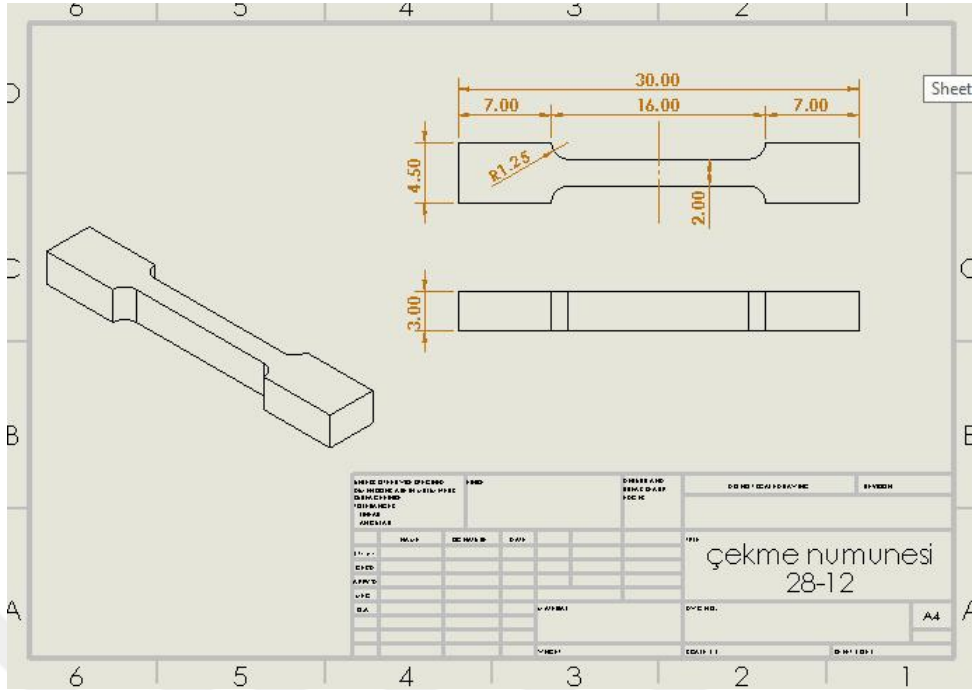

Figure 4.2. Tensile test design.

#### 4.2. PRINTING AND PROCESS PARAMETERS

In order to produce the samples, a 3D printer was used: endre3 pro. This printer was produced by Creality3D Company (Chinese 3D printer manufacturing company established in 2014).



Figure 4.3. Ender3 pro 3d printer.

Practically we have prepared the printer nozzle with a diameter of 0.4 mm.

The diameter of the filament used is 1.75 mm.

As for the design parameters, the design was exported from Solidworks to a 3D-printed slicing program.

We used a slicing program called CURA.

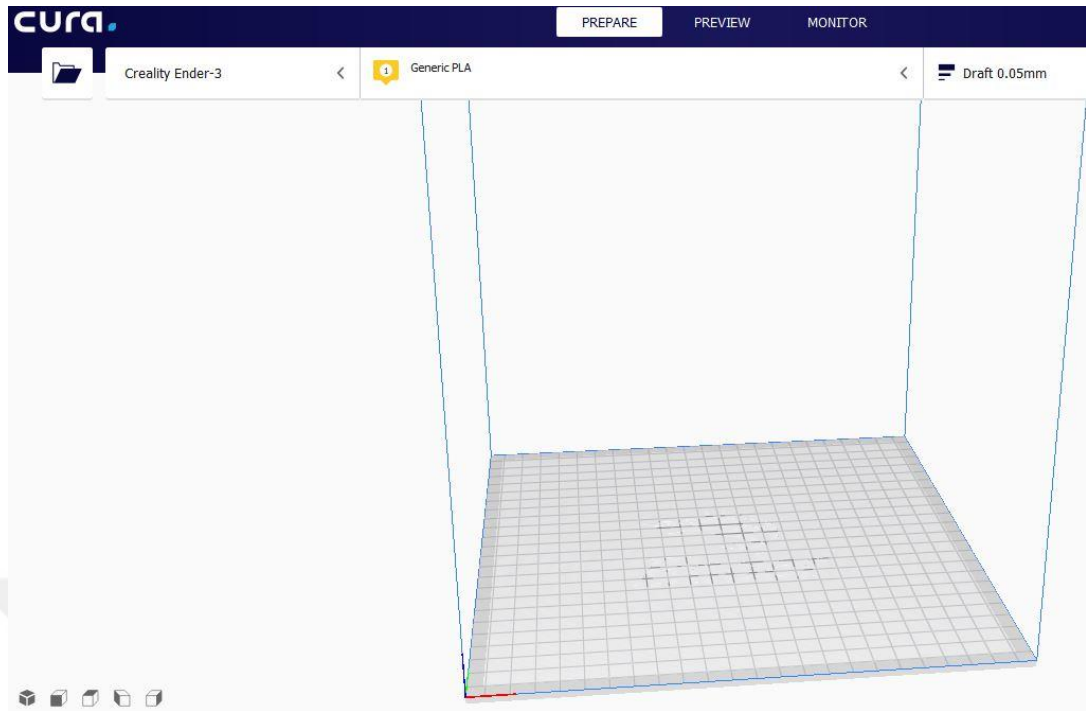

Figure 4.4. Cura slicing application for 3D printers.

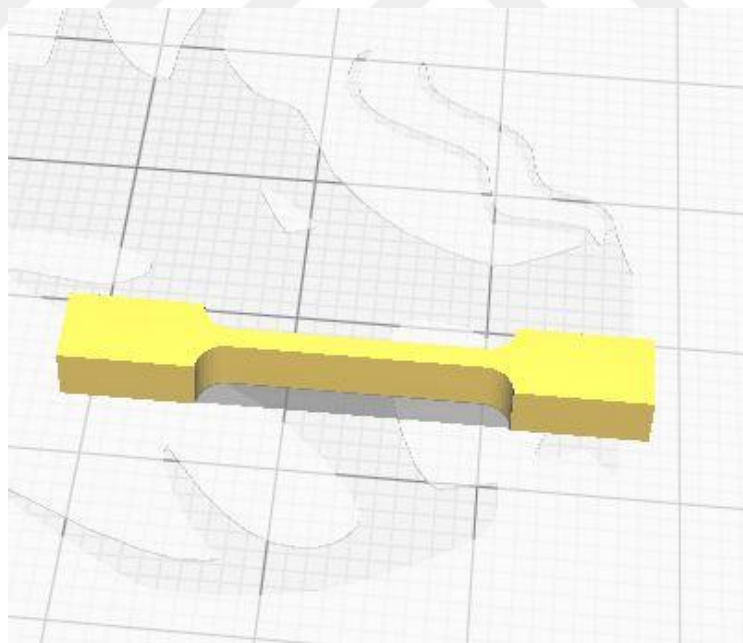

Figure 4.5. Tensile sample at Cura application.

By using the CURA program, we have determined the specific parameters according to the following table:

Table 4.1. 3D printing parameters used in the research.

Parameters	Sample 1	Sample 2	Sample 3	Sample 4	Sample 5	Sample 6
Material	PLA	PLA	Pla with15%cf	Pla with15%cf	Pla with 20%cf	Pla with 20%cf
Infill density	100%	70%	100%	70%	100%	70%
Infill Pattern	Line	Line	Line	Line	Line	Line
Nozzle Diameter	0.4 mm	0.4 mm	0.4 mm	0.4 mm	0.4 mm	0.4 mm
Line width	0.4 mm	0.4 mm	0.4 mm	0.4 mm	0.4 mm	0.4 mm
Layer height	0.12 mm	0.12 mm	0.12 mm	0.12 mm	0.12 mm	0.12 mm
Extruder temperature	200 C°	200 C°	200 C°	200 C°	200 C°	200 C°
Bed temperature	60 C°	60 C°	60 C°	60 C°	60 C°	60 C°
Print Speed	50 mm/S	50 mm/S	50 mm/S	50 mm/S	50 mm/S	50 mm/S

**Note:** During the manufacture of samples only the first two types of parameters (Material and Infill density) shown in the table were changed.

After we have finished setting the parameters, we click on the Slice option:

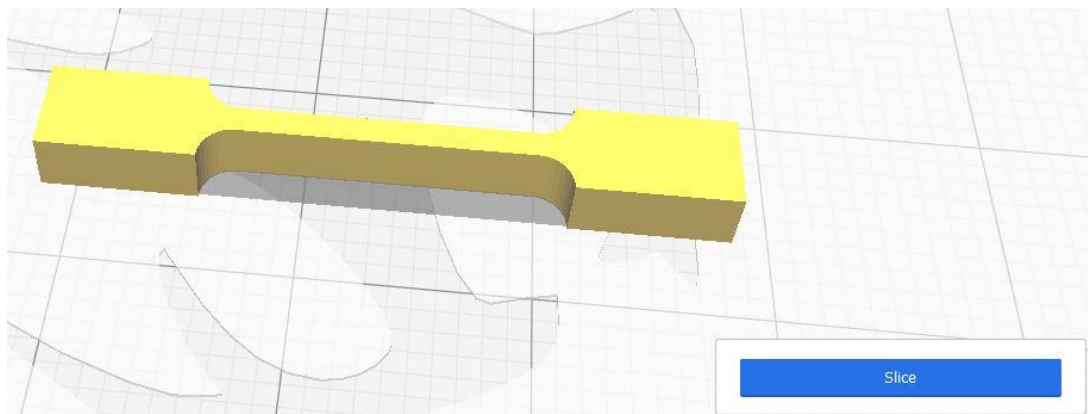

Figure 4.6. Slice option in Cura application.

After we have finished setting the parameters, we click on the slice option:

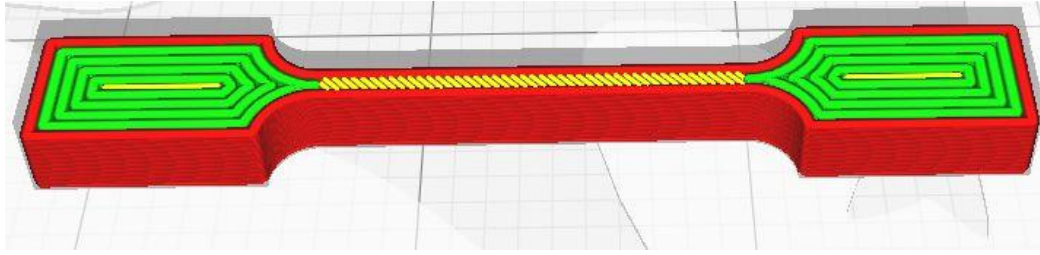

Figure 4.7. Prepare the sample into layers.

The shape is slice into layers that will be built one by one on top of each other.

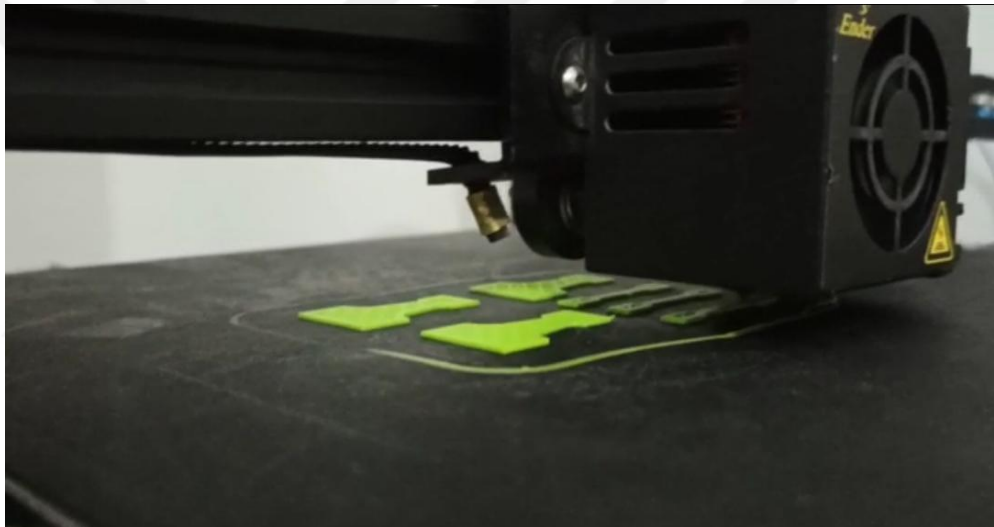

Figure 4.8. 3D printer during sample printing process.

After we finished printing all the samples according to the specified parameters, we arranged the samples according to specific groups.

### **4.3. EXPERIMENTATION**

#### **4.3.1. Tensile Test**

The tensile strength of the Samples was tested by fixture on the testing machine. A tensile property was tested by using three samples in order to ensure the repeatability of the test results. A tensile velocity of 10mm/min was applied during the test

The results of tensile experiments showed the following results:

- Sample 1 (0% cf 100% infill):

In this sample, the ultimate tensile strength was 56.3 MPa, and the Young's modulus was 2.09 Gpa.

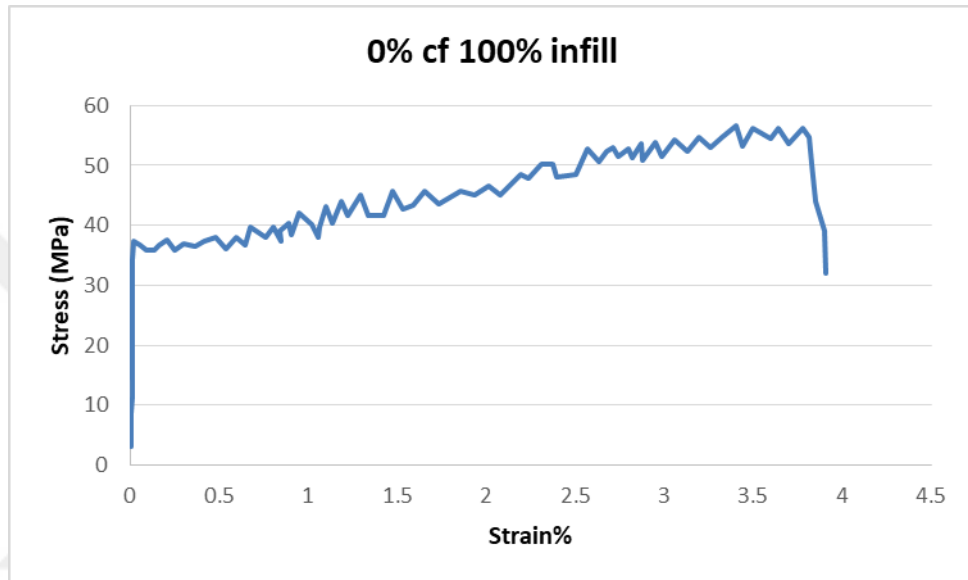

Figure 4.9. Tensile test curve for (Sample 1).

- Sample 2 (0% cf 70% infill):

In this sample, the ultimate tensile strength was 50.12 MPa, and the Young's modulus was 1.9 Gpa.

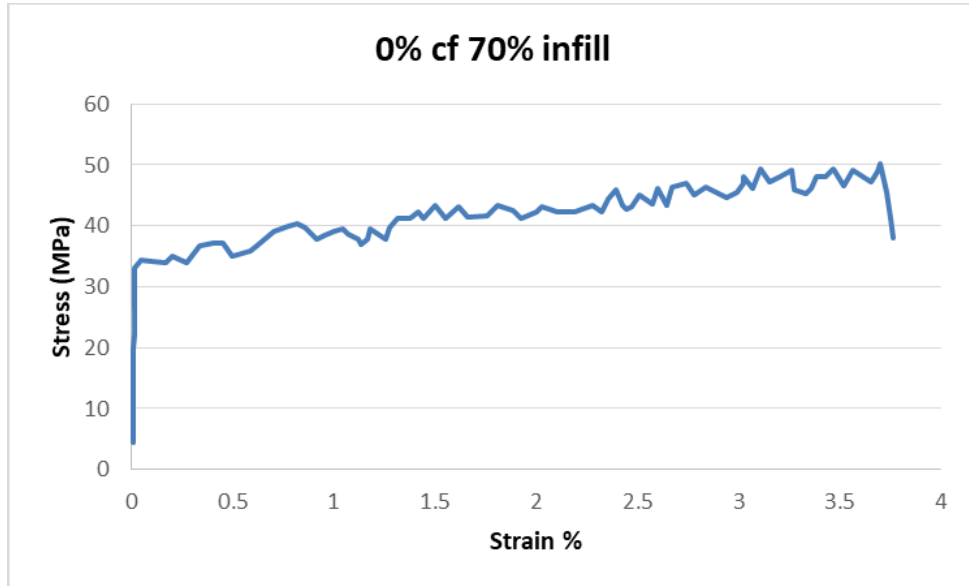

Figure 4.10. Tensile test curve for (Sample 2).

- Sample 3 (15% cf 100% infill):

In this sample, the ultimate tensile strength was 61.6 MPa, and the Young's modulus was 2.97 Gpa.

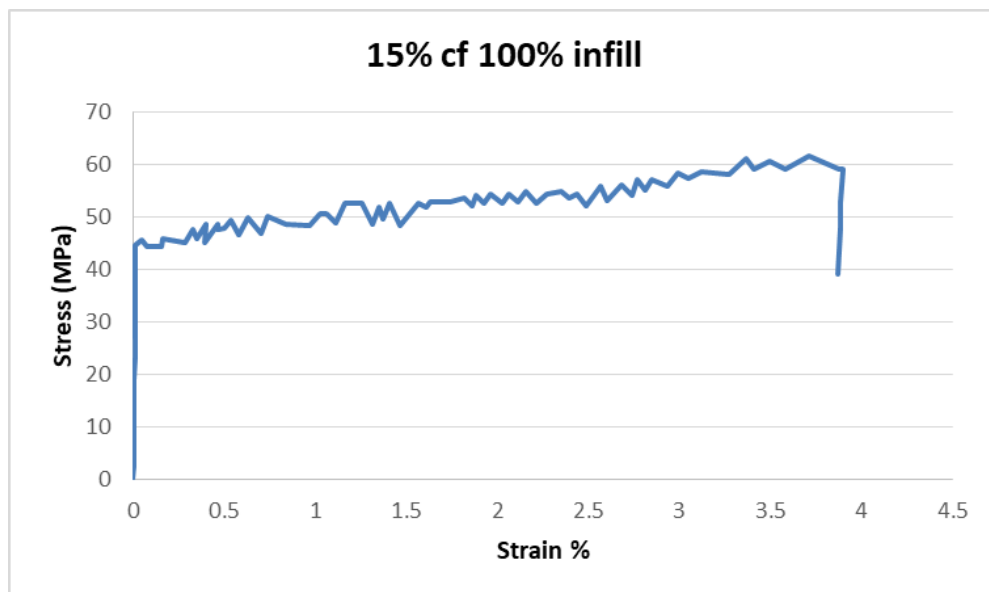

Figure 4.11. Tensile test curve for (Sample 3).

- Sample 4 (15% cf 70% infill):

In this sample, the ultimate tensile strength was 58.32 MPa, and the Young's modulus was 2.65 Gpa.

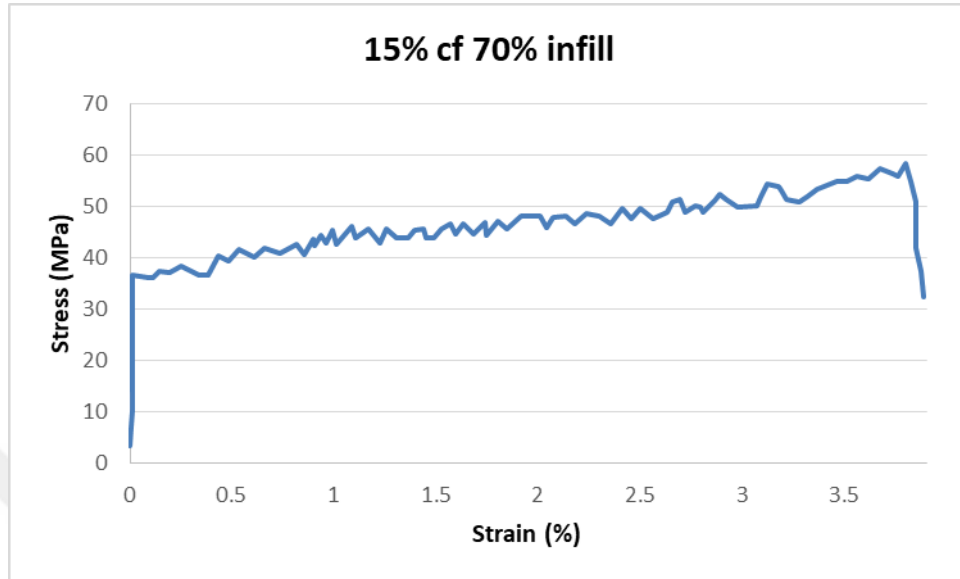

Figure 4.12. Tensile test curve for (Sample 4)

- Sample 5 (20% cf 100% infill):

In this sample, the ultimate tensile strength was 44.21 MPa, and the Young's modulus was 1.68 Gpa.

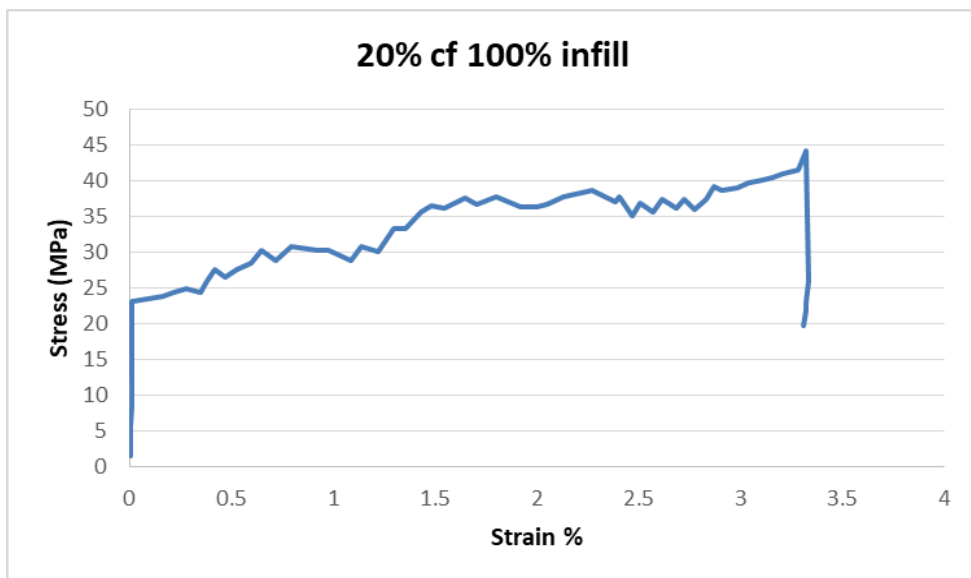

Figure 4.13. Tensile test curve for (Sample 5).

- Sample 6 (20% cf 70% infill):

In this sample, the ultimate tensile strength was 41.6 MPa, and the Young's modulus was 1.5 Gpa.

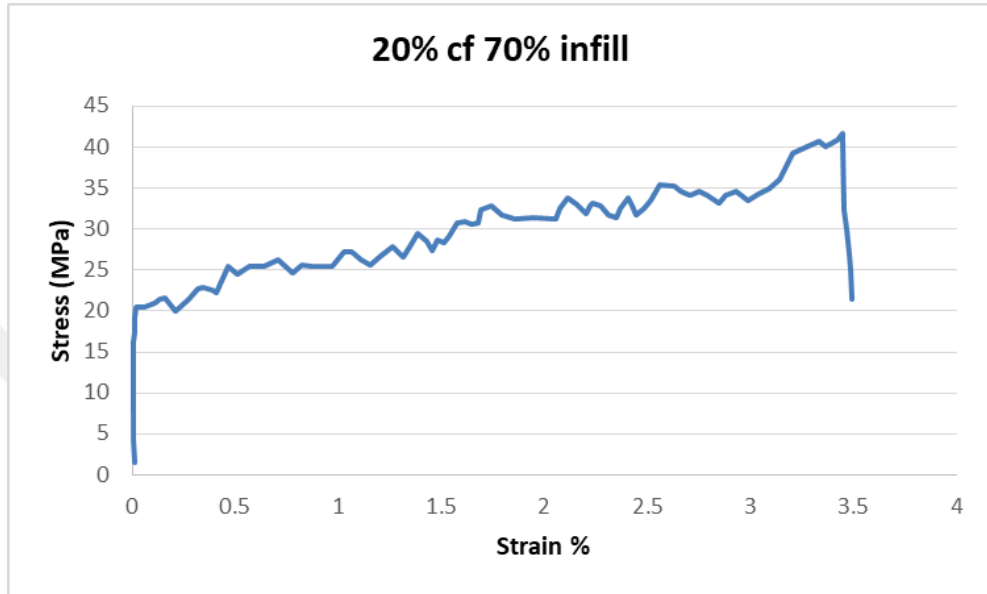

Figure 4.14. Tensile test curve for (Sample 6).

By putting all the results in one place, the results can be compared more clearly.

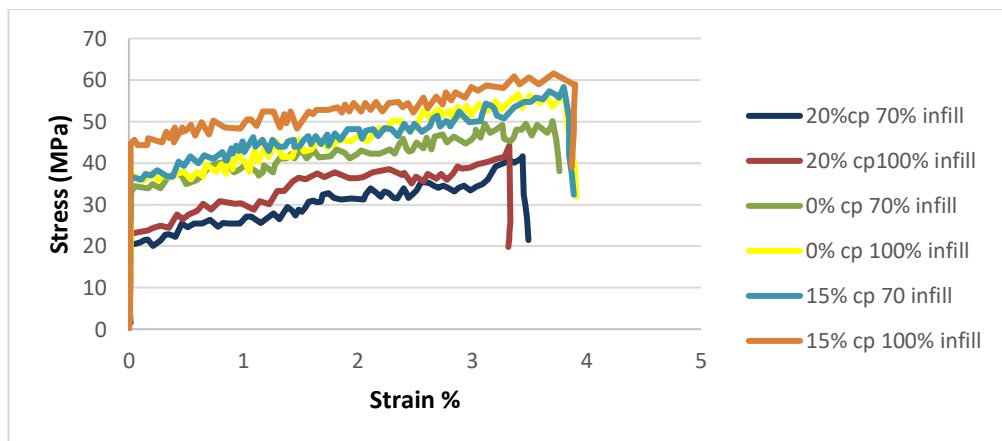

Figure 4.15. Tensile test curve for all samples.

### 4.3.2. Fatigue Test

We did a fatigue test using a locally manufactured device. The device consists of two jaws, one movable jaw and the other fixed and motor. The device contains software that can determine the number of cycles per minute. The device loads the material for bending loads of constant amplitude. The upper and lower distances over which the sample will move are fixed. The distance the specimen will move during testing is determined by the adjusting bolt.

The device applies a variable load to the piece and at the same time counts the cycles.

When the sample is broken, we take a reading of the number of cycles the substance has reached when it fractured.

A SN-Curve (sometimes written S-N Curve) is a plot of the magnitude of an alternating stress versus the number of cycles to failure for a given material. Typically both the stress and number of cycles are displayed on logarithmic scales.

Then we draw the diagram between stress amplitude and number of cycle to failure.

A SN-Curve or (S-N Curve) is a plot of the measure of an alternating stress and the number of cycles to failure for a material [25].

stress amplitude is calculated by the equation:

$$\sigma = E \frac{6\sigma h}{L^2} \quad (4.1)$$

This law was arrived at from the following relations:

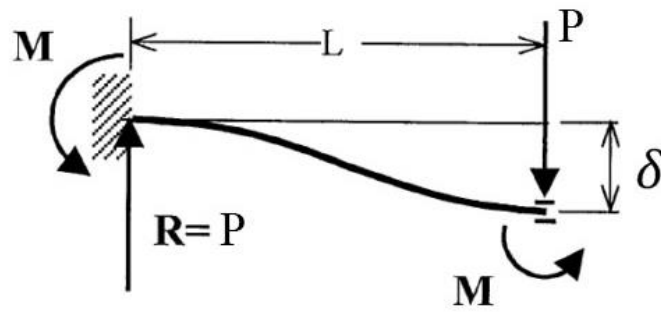

Figure 4.16. Guided cantilever beam [26].

$$\text{Equivalent bending stress } \sigma = \frac{M_b}{I} y$$

$$M_b = PL, \quad I = \frac{bh^3}{12}, \quad y = \frac{h}{2}$$

$$\rightarrow \sigma = \frac{PL}{\frac{bh^3}{12}} \frac{h}{2} \rightarrow \sigma = 6 \frac{PL}{bh^3}$$

$$P = 12 \frac{EI}{L^3} \delta \rightarrow \sigma = 6 \frac{12 \frac{EI}{L^3} \delta L}{bh^3} = \frac{12 \frac{E}{L^3} \frac{bh^3}{12} \delta L}{bh^3} = 6 \frac{E\sigma h}{L^2}$$

$$\boxed{\sigma = E \frac{6\sigma h}{L^2}}$$

E: Young's modulus [N/m<sup>2</sup>].

$\delta$ : Maximum amount of bending deformation [m].

b: Width of the sample [m].

h: Thickness of the sample [m].

L: Distance between supports [m].

The results of fatigue experiments showed the following results:

- Sample 1 (0% cf 100% infill):

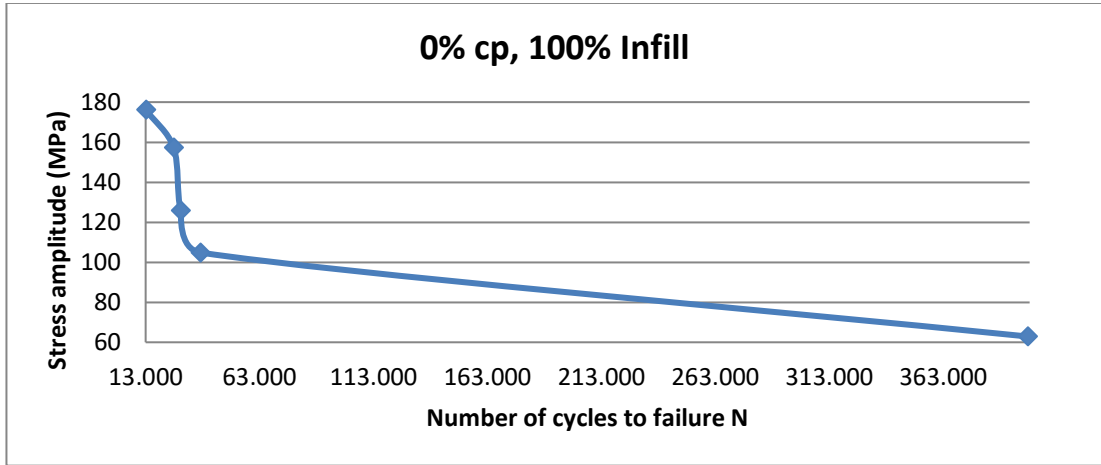

Figure 4.17. S-N Curve for (Sample 1)Ç

- Sample 2 (0% cf 70% infill):

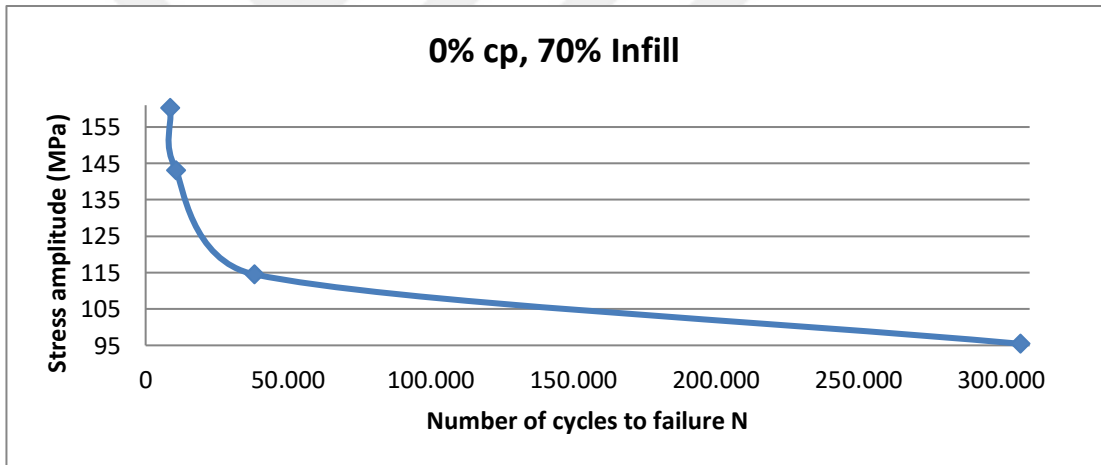

Figure 4.18. S-N Curve for (Sample 2).

- Sample 3 (15% cf 100% infill):

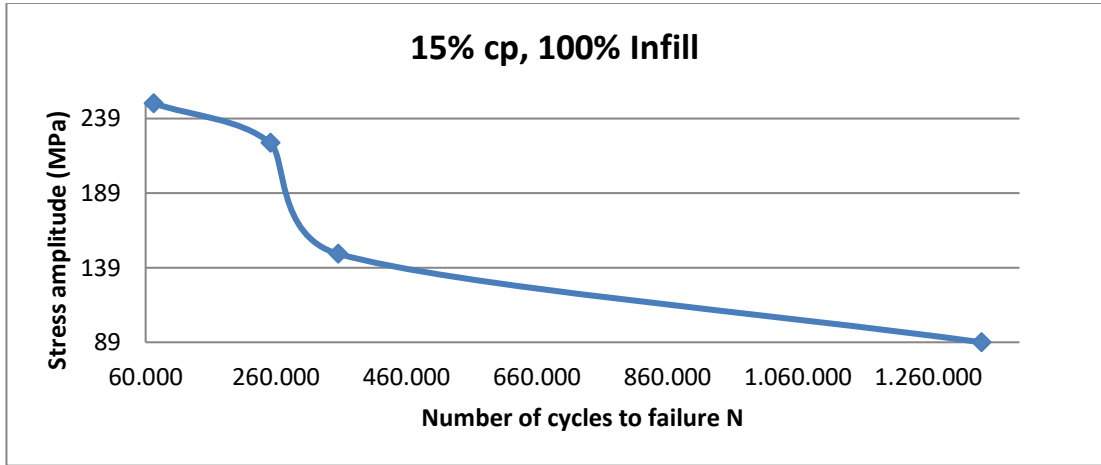

Figure 4.19. S-N Curve for (Sample 3).

- Sample 4 (15% cf 70% infill):

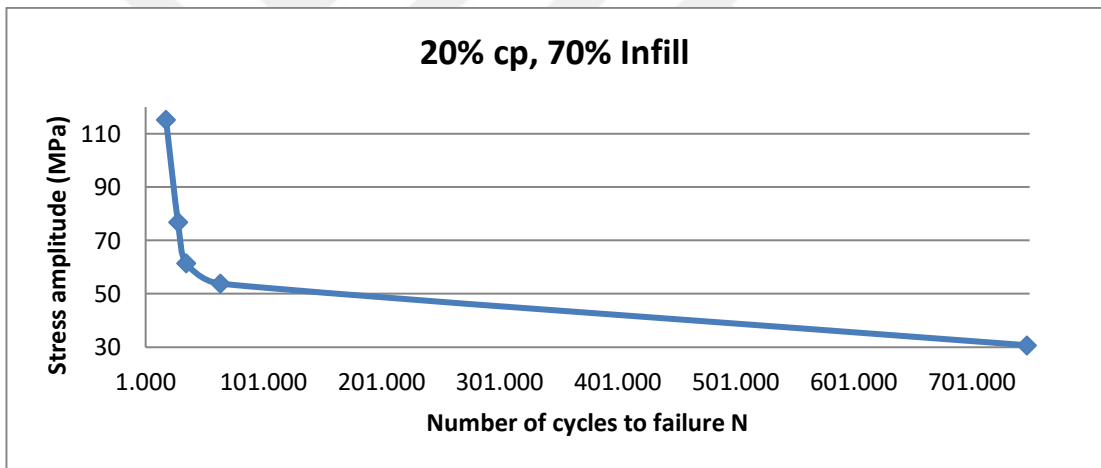

Figure 4.20. S-N Curve for (Sample 4).

- Sample 5 (20% cf 100% infill):

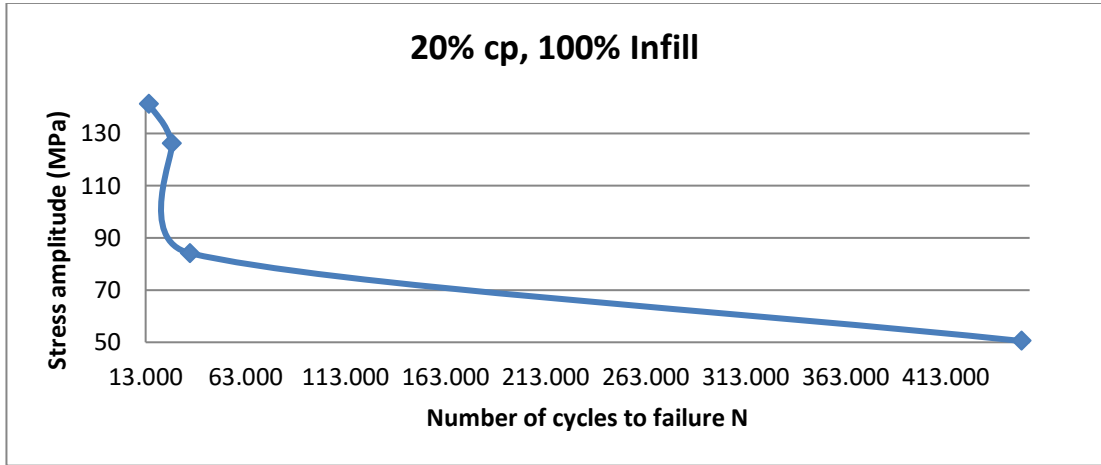

Figure 4.21. S-N Curve for (Sample 5).

- Sample 6 (20% cf 70% infill):

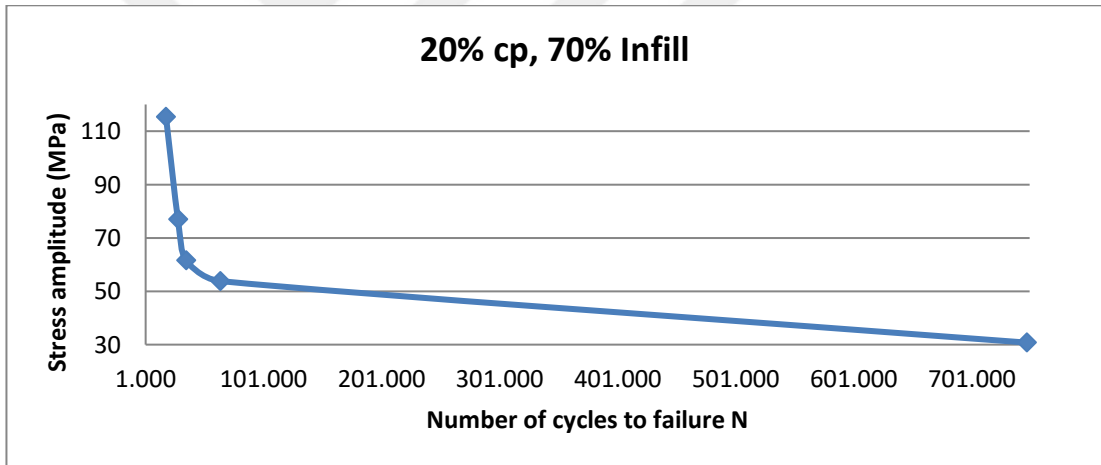

Figure 4.22. S-N Curve for (Sample 6).

By putting all the results in one place, the results can be compared more clearly

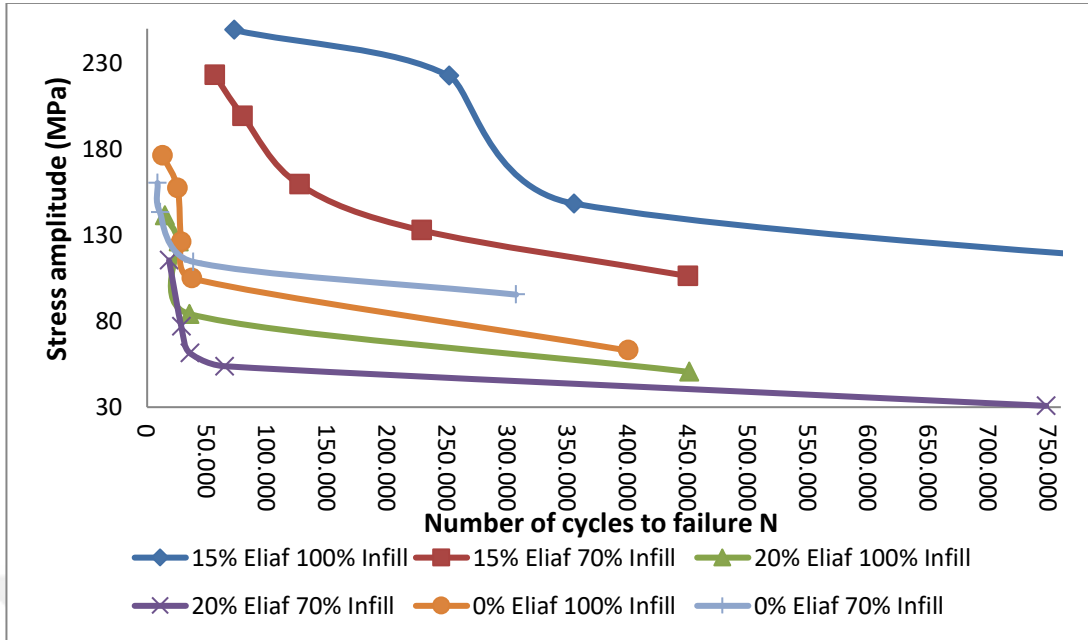

Figure 4.23. Number of cycles to failure N.

The main reason for the deterioration in the mechanical properties of PLA backed with 20% carbon fiber is due to the poor adhesion of the plastic layers during printing. Where carbon fibers cause weaknesses in the adhesion of the layers.

## PART 5

### RESULTS, DISCUSSION AND SUMMARY

#### 5.1. RESULTS AND DISCUSSION

##### 5.1.1. Tensile Test

By reading the results in the practical part of the **tensile test**, we can collect the results according to the following tables:

Table 5.1. Results of tensile test for all samples.

Sample	E (GPa)	U (MPa)
0% cf 100% infill	2.10	56.3
0% cf 70% infill	1.91	50.12
15% cf 100% infill	2.97	61.6
15% fc 70% infill	2.66	58.32
20% cf 100% infill	1.69	44.2
20% cf 70% infill	1.54	41.6

In order to make it easier to compare the results, we drew the following charts:

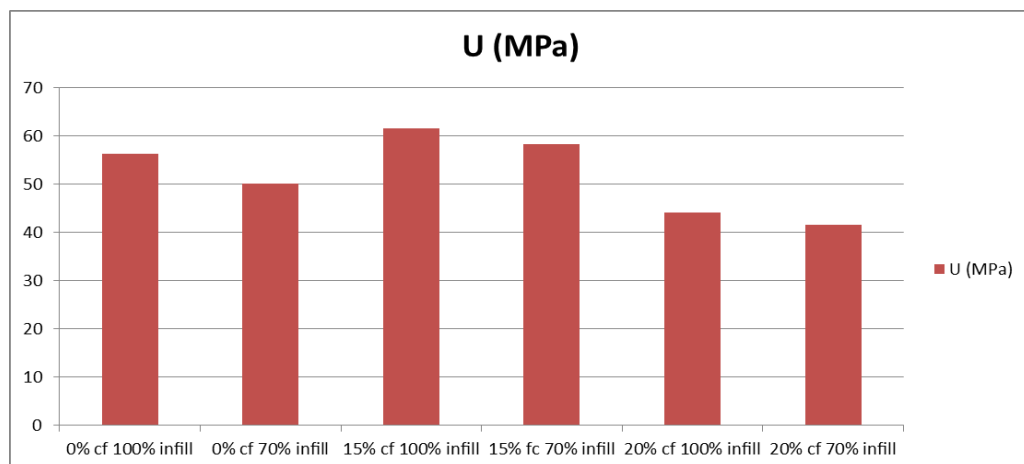

Figure 5.1. Ultimate tensile strength for all samples.

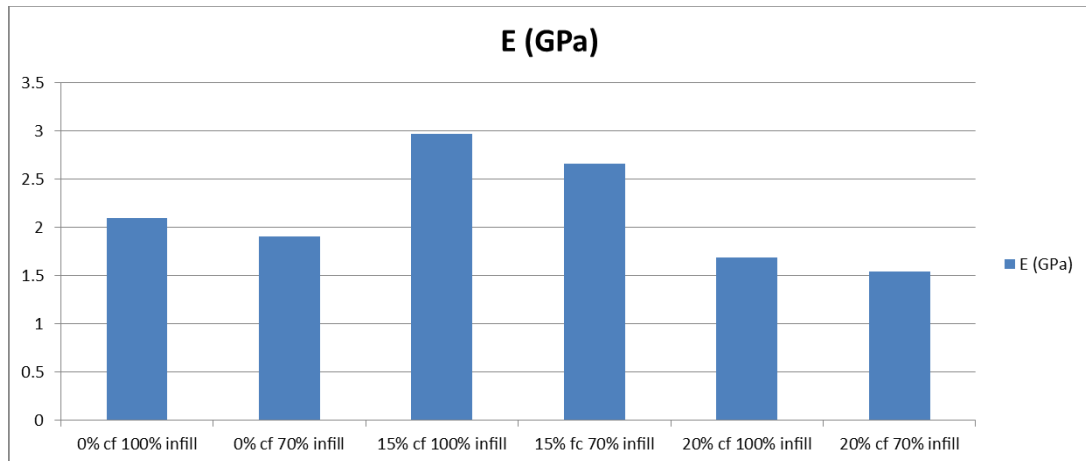

Figure 5.2. Young's modulus for all samples.

From these results, we conclude the following:

- The Sample (15% cf 100% infill) have the highest ultimate tensile strength (61.6 MPa). While the sample made of pure PLA (0% cf 100% infill) achieved an ultimate tensile strength of 56.3 MPa. In other words, adding carbon fiber to PLA by 15% has contributed to improving the mechanical properties of the material by a percentage of 8.6%.
- The Sample (15% cf 70% infill) have an ultimate tensile strength (58.32 MPa). While the sample made of pure PLA (0% cf 70% infill) achieved an ultimate tensile strength of 50.12 MPa. In other words, adding carbon fiber to PLA by 15% has contributed to improving the mechanical properties of the material by a percentage of 14.06%.
- The Sample (20% cf 100% infill) have an ultimate tensile strength (44.2 MPa). While the sample made of pure PLA (0% cf 100% infill) achieved an ultimate tensile strength of 56.3 MPa. And the sample (15% cf 100% infill) achieved an ultimate tensile strength of 61.6 MPa. This means that adding more than 15% of carbon resulted in:
  - Mechanical properties decreased by 21% compared to pure PLA (0% cf 100% infill).
  - Mechanical properties decreased by 28.2% compared to (15% cf 100% infill) by 15%.

- Increasing the percentage of infill density leads to an increase in the mechanical properties, according to the following:
  - When comparing the filling percentage of the material made of pure PLA, the result was an increase in mechanical properties by 10.9%.
  - When comparing the filling percentage of the material made of PLA reinforced with 15% carbon fiber, the result was an increase in mechanical properties by a percentage of 5.3%.
  - When comparing the filling percentage of the material made of PLA reinforced with 20% carbon fiber, the result was an increase in mechanical properties by a percentage of 5.8%.
- The (15% cf 100% infill) sample achieved the highest Young's modulus value of 61.6.
- For samples with a fill rate of 100%, the of the Young's modulus results were as follows:
  - The sample reinforced with 15% carbon fiber achieved an increase of 43.1% compared to the sample reinforced with 20% carbon fiber and 29.2% compared to the sample made of pure PLA.
- For samples with a fill rate of 70%, the of the Young's modulus results were as follows:
  - The sample reinforced with 15% carbon fiber achieved an increase of 42.1% compared to the sample reinforced with 20% carbon fiber and 28.1% compared to the sample made of pure PLA.

### 5.1.2. Fatigue Test

By reading the results in the practical part of the **fatigue test**, we can collect the results according to the following table:

- 15% cp 100% Infill:

Table 5.2. Results of fatigue test for the sample (15% cp 100% Infill).

Test No.	E	$\delta$	h	L	No. of Cycle	$\sigma$
1	2971.649148	0.3	2.6	12.5	1,341,408	89.006835
2	2971.649148	0.5	2.6	12.5	355,088	148.344725
3	2971.649148	0.75	2.6	12.5	251,186	222.517088
4	2971.649148	0.84	2.6	12.5	72,212	249.219139

- 15% cp 70% Infill:

Table 5.3. Results of fatigue test for the sample (15% cp 70% Infill).

Test No.	E	$\delta$	h	L	No. of Cycle	$\sigma$
1	2659.463768	0.4	2.6	12.5	450,000	106.208345
2	2659.463768	0.5	2.6	12.5	228,444	132.760431
3	2659.463768	0.6	2.6	12.5	126,899	159.312518
4	2659.463768	0.75	2.6	12.5	79,637	199.140647
5	2659.463768	0.84	2.6	12.5	56,259	223.037525

- 20% cp 100% Infill:

Table 5.4. Results of fatigue test for the sample (20% cp 100% Infill).

Test No.	E	$\delta$	h	L	No. of Cycle	$\sigma$
1	1685.24971	0.3	2.6	12.5	451,022	50.476599
2	1685.24971	0.5	2.6	12.5	35,215	84.127666
3	1685.24971	0.75	2.6	12.5	26,156	126.191498
4	1685.24971	0.84	2.6	12.5	14,598	141.334478

- 20% cp 70% Infill:

Table 5.5. Results of fatigue test for the sample (20% cp 70% Infill).

Test No.	E	$\delta$	h	L	No. of Cycle	$\sigma$
1	1540.257374	0.2	2.6	12.5	747,788	30.755859
2	1540.257374	0.35	2.6	12.5	64,211	53.822754
3	1540.257374	0.4	2.6	12.5	35,373	61.511718
4	1540.257374	0.5	2.6	12.5	28,381	76.889648
5	1540.257374	0.75	2.6	12.5	18,233	115.334472

- 0% cp 100% Infill:

Table 5.6. Results of fatigue test for the sample (0% cp 100% Infill)

Test No.	E	$\delta$	h	L	No. of Cycle	$\sigma$
1	2099.393237	0.3	2.6	12.5	400,288	62.881026
2	2099.393237	0.5	2.6	12.5	37,157	104.801710
3	2099.393237	0.6	2.6	12.5	28,416	125.762052
4	2099.393237	0.75	2.6	12.5	25,310	157.202566
5	2099.393237	0.84	2.6	12.5	13,130	176.066873

- 0% cp 70% Infill:

Table 5.1. Results of fatigue test for the sample (0% cp 70% Infill)

Test No.	E	$\delta$	h	L	No. of Cycle	$\sigma$
1	1911.422181	0.5	2.6	12.5	306,874	95.418195
2	1911.422181	0.6	2.6	12.5	38,177	114.501834
3	1911.422181	0.75	2.6	12.5	10,691	143.127293
4	1911.422181	0.84	2.6	12.5	8,638	160.302568

We chose a specific displacement distance ( $\delta$ ) for each experiment in order to measure the number of cycles at which the material would failure.

By reading the chart below, we can compare the results of the fatigue test between different samples.

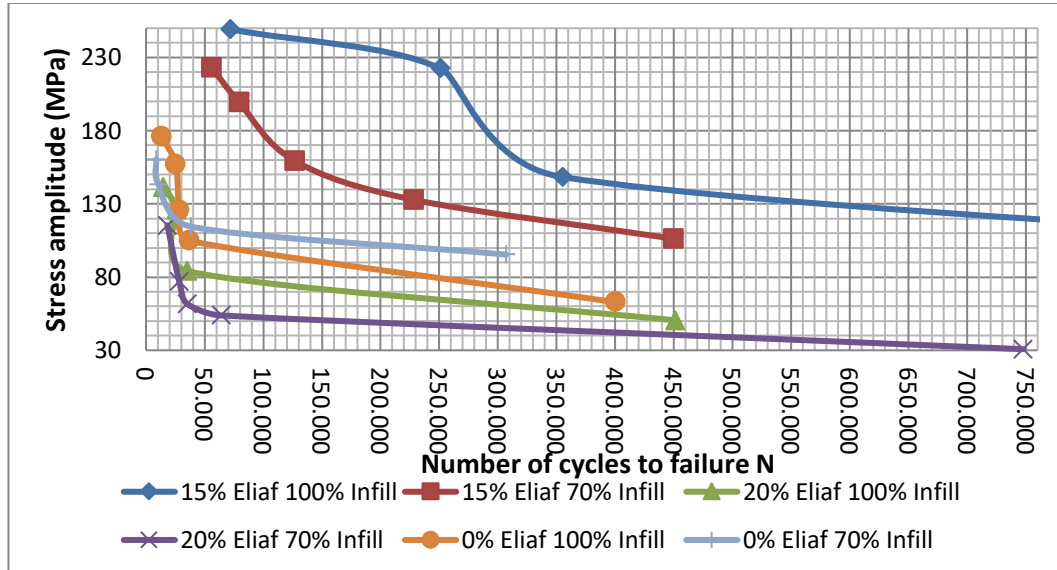

Figure 5.3. S-N Curve for All Samples with gridlines.

We deduce from the previous table the following results:

- The sample with the highest fatigue strength is (15% cf 100 infill).
- The sample with the lowest fatigue strength is (20% cf 70 infill).
- When an alternating load is applied to the samples at 40,000 cycle, the following is observed:
  - The sample (20 cp-70 infill) failure when stress amplitude of 57 MPa is applied.
  - The sample (20 cp -100 infill) failure after applying stress amplitude of 84 MPa.
  - The sample (0 cp-100 infill) failure after applying stress amplitude of 104 MPa.
  - The sample (0 cp-70 infill) failure after applying stress amplitude of 115 MPa.
  - While the sample (15 cp-70 infill) applied a higher stress amplitude than the previous samples without the possibility of determining the exact value.
  - The sample (15 cp-100 infill) reached the highest stress amplitude among all samples without the possibility of determining the exact value.

- When an alternating load is applied to the samples at 200,000 cycle, the following is observed:
  - The sample (20 cp-70 infill) failure when stress amplitude of 49 MPa is applied.
  - The sample (20 cp -100 infill) failure after applying stress amplitude of 67 MPa.
  - The sample (0 cp-100 infill) failure after applying stress amplitude of 85 MPa.
  - The sample (0 cp-70 infill) failure after applying stress amplitude of 101 MPa.
  - The sample (15 cp-70 infill) failure after applying stress amplitude of 148 MPa.
  - The sample (15 cp-100 infill) failure after applying stress amplitude of 235 MPa.

The main reason for the low mechanical properties of PLA with 20% carbon fiber, is the poor adhesion of the plastic layers during printing. Where carbon fibers cause weaknesses in the adhesion of the layers.

### **5.1.3. Scanning Electron Microscopic (SEM)**

A SEM microscope was used on the avalanche section for all samples and the following micrographs were obtained:

- 15% cp 100% Infill:

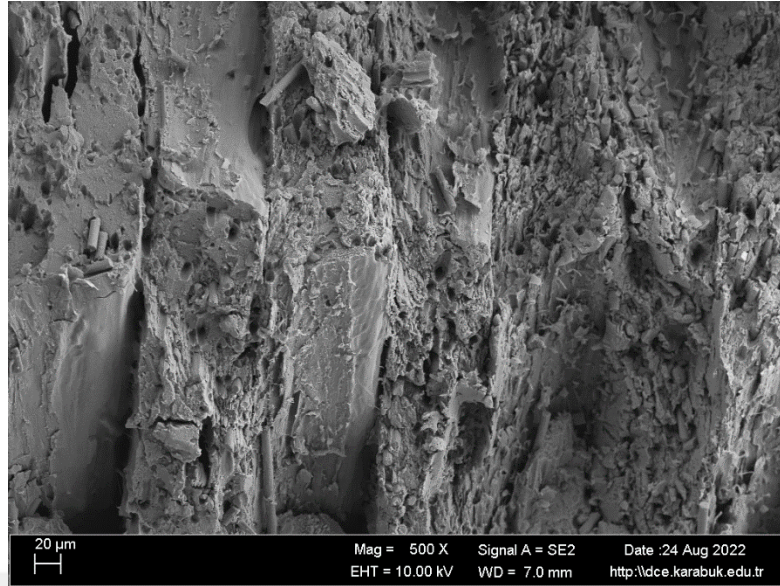

Figure 5.4. SEM micrographs of cross section (15%cp, 100% infill).

- 15% cp 70% Infill:

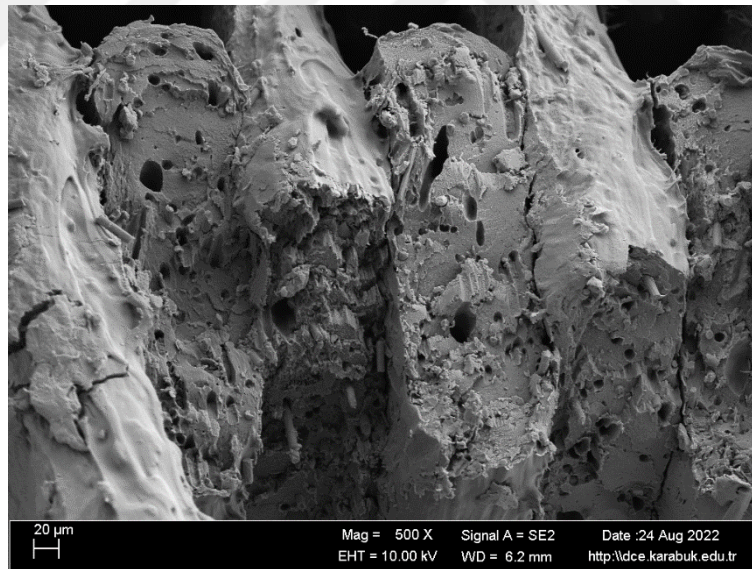

Figure 5.5. SEM micrographs of cross section (15%cp, 70% infill).

- 20% cp 100% Infill:

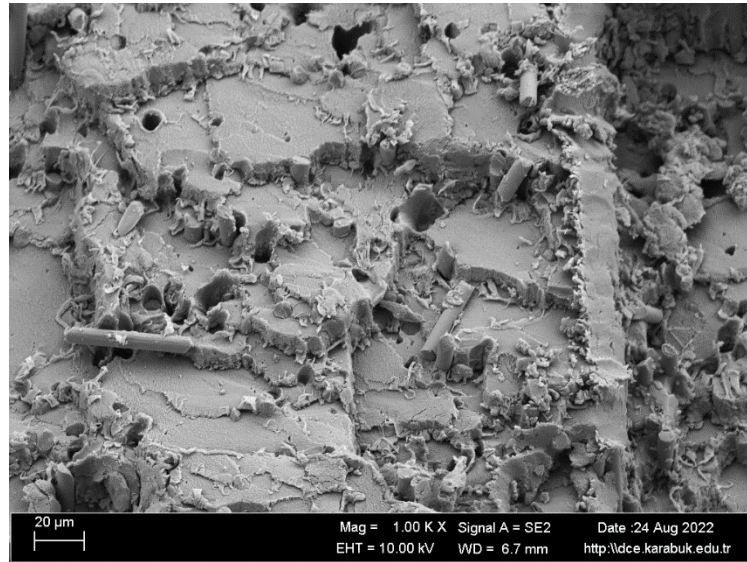

Figure 5.6. SEM micrographs of cross section (20%cp, 100% infill).

- 20% cp 70% Infill:

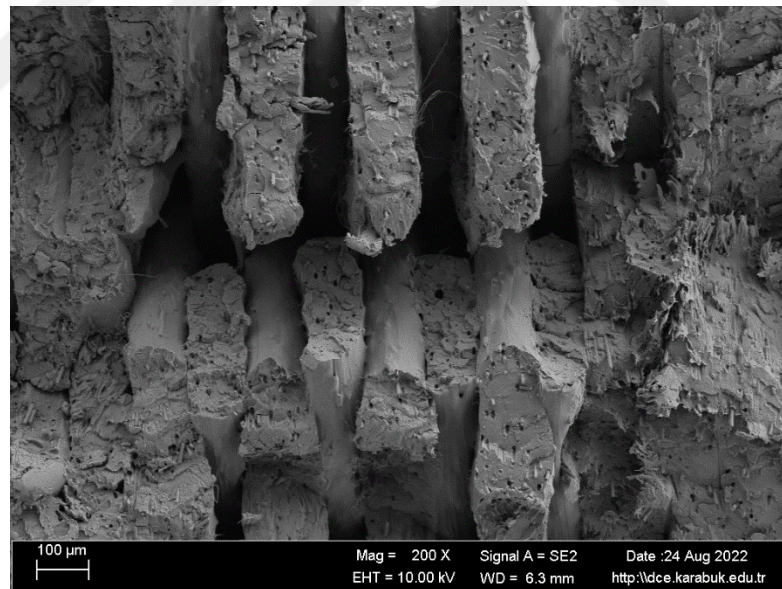

Figure 5.7. SEM micrographs of cross section (20%cp, 70% infill).

- 0% cp 100% Infill:

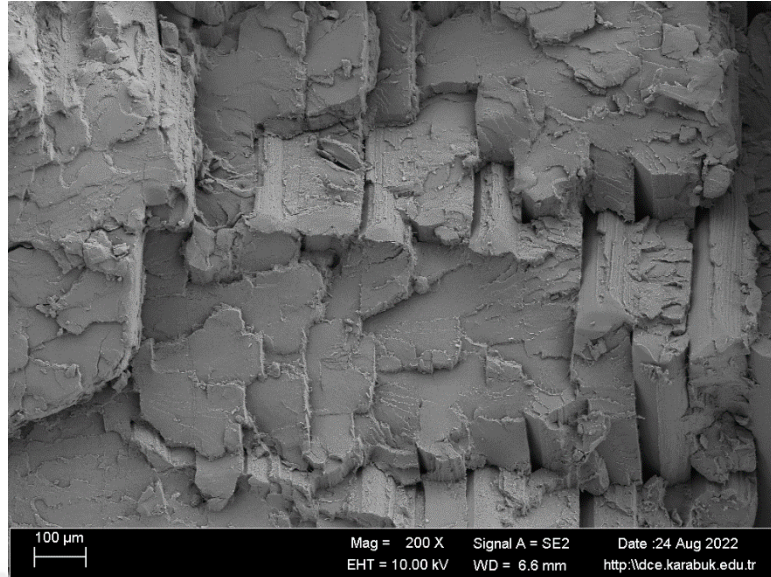

Figure 5.8. SEM micrographs of cross section (0%cp, 100% infill).

- 0% cp 70% Infill:

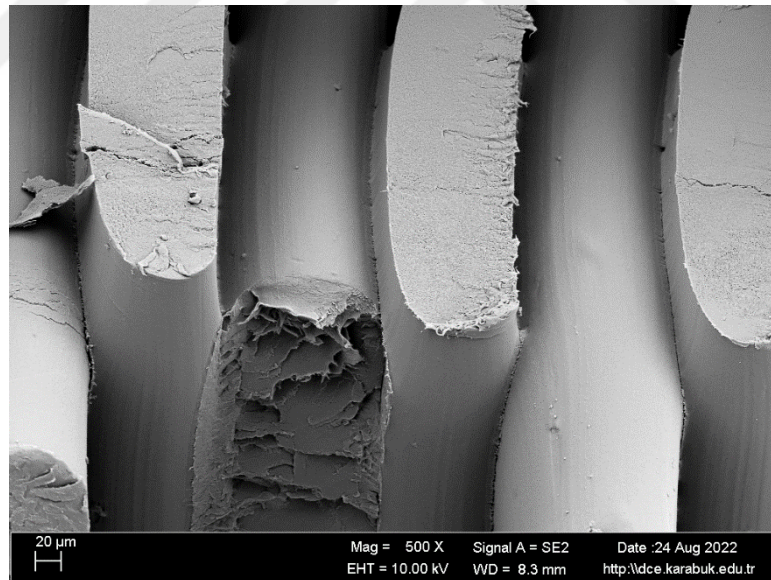

Figure 5.9. SEM micrographs of cross section (0%cp, 70% infill).

The microscopic images of the samples with 20% cp (figure 5.6 and figure 5.7) show a slight lack of adhesion of the printing layers, which caused a negative effect on the resistance of the sample.

Micrographs of the samples with 15% cp (figure 5.4 and figure 5.5) show better adhesion of the print layers.

As for the microscopic images of the samples (figure 5.8 and figure 5.9), we notice that they have very good adhesion to the printing layers.

When using samples with 100% infill density (figure 5.4 and figure 5.6 and figure 5.8), we noticed no large voids in the cross section. This in turn contributed to the increase in the strength of the material.



## **PART 6**

### **RECOMMENDATIONS AND PROPOSALS**

#### **6.1. RECOMMENDATIONS**

Through the results of the tests that we obtained and after referring to books, sources, research papers and reference studies, we recommend the following:

- The use of PLA reinforced with 15% carbon fiber in 3D printing in order to obtain higher tensile strength and stress amplitude.
- The use of PLA reinforced with 20% carbon fiber in 3D printing (with the parameters we used) leads to a deterioration of the mechanical properties of the material in both tensile and fatigue trials.
- Using pure PLA (without carbon fibres) in 3D printing (with the parameters we used) has better results than samples (20% cp) and weaker than sample(15% cp).

#### **6.2. PROPOSALS**

- Studying the tensile and fatigue properties of 3D printed PLA samples, with different percentages of carbon fibers (>15% and <20%) in order to determine the highest efficiency ratio.
- Study of the tensile and fatigue properties of 3D printed PLA material, with changing infill pattern and infill density ratios.
- Study of the same material (PLA) and the same ratios of carbon fibers, but with the change of carbon fiber pattern from short fibers to continuous fibers.
- Studying other polymeric materials used in 3D printing other than PLA (such as ABS and PETG), with the addition of different proportions of carbon fibers to it.

- Study of the factors affecting the adhesion of layers in 3D printing when carbon fibers are present
- Study of factors affecting the adhesion of carbon fiber-reinforced PLA layers in 3D printing.



## REFERENCE

1. Internet: Introduction to 3D Printing, in 3D Printing in Chemical Sciences: Applications Across Chemistry, 2019, pp. 1-21 **DOI: 10.1039/9781788015745-00001** (2019).
2. Gibson, I.; Rosen, D.; Stucker, B. Additive Manufacturing Technologies—3D Printing, Rapid Prototyping, and Direct Digital Manufacturing, 2nd ed.; Springer: New York, NY, USA (2015).
3. Internet: Cakar, S., Ehrmann, A., 3D Printing with Flexible Materials – Mechanical Properties and Material Fatigue. Macromol. Symp. 2021, 395, 2000203. <https://doi.org/10.1002/masy.202000203> (2021).
4. Internet: Ma, Q., Rejab, M., Kumar, A. P., Fu, H., Kumar, N. M., & Tang, J. (2021). Effect of infill pattern, density and material type of 3D printed cubic structure under quasi-static loading. Proceedings of the Institution of Mechanical Engineers, Part C: Journal of Mechanical Engineering Science, 235(19), 4254–4272. <https://doi.org/10.1177/0954406220971667> (2021).
5. K. Deshmukh, K. Chidambaram, in Biopolymer Composites in Electronics, 2017-Biopolymer Composites with High Dielectric Performance: Interface Engineering (2017).
6. Sonsino CM. Principles of variable amplitude fatigue design and testing Fatigue testing and analysis under variable amplitude loading conditions. In: McKeighan PC, Ranganathan N, editors. ASTM STP, vol. 1439. West Conshohocken, PA: ASTM International (2005).
7. Gonzalez D., Álvarez A., 2018-Additive manufacturing feasibility study & technology demonstration. European Defence Agency, 1ed, Europe, 195 (2018).
8. Horvath j, 2014-Mastering 3D Printing. Apress, 1ed, California, (2014).
9. Van Wijk, A. J. M., and Iris van Wijk. 3D printing with biomaterials: Towards a sustainable and circular economy. IOS press (2015).
10. Hanon M. Introduction to 3D printing technologies: techniques, materials, and applications. Szent Istevan University (2020).
11. Farah, Shady, Daniel G. Anderson, and Robert Langer. "Physical and mechanical properties of PLA, and their functions in widespread applications—A comprehensive review." Advanced drug delivery reviews 107 (2016).
12. Maker Bot., 2020-2020 Guide to 3D printing materials (2020).

13. Ortiz-Acosta, Denisse, and Tanya Moore. "Functional 3D printed polymeric materials." *Functional Materials* (2019).
14. Dana, H. Ramezani, Fabrice Barbe, Laurent Delbreilh, M. Ben Azzouna, Alain Guillet, and Thomas Breteau. "Polymer additive manufacturing of ABS structure: Influence of printing direction on mechanical properties." *Journal of Manufacturing Processes* 44 (2019).
15. Pernet, B., Nagel, J. K., & Zhang, H. (2022). Compressive Strength Assessment of 3D Printing Infill Patterns (2022)
16. Parab, S., & Zaveri, N. (2020). Investigating the Influence of Infill Pattern on the Compressive Strength of Fused Deposition Modelled PLA Parts (2020).
17. Internet: <https://all3dp.com/2/infill-3d-printing-what-it-means-and-how-to-use-it> (2022).
18. King, Caleb & Hong, Yili & Dehart, Stephanie & Defeo, Patrick & Pan, Rong. (2016). Planning Fatigue Tests for Polymer Composites. *Journal of Quality Technology*. 48. 227-245. 10.1080/00224065.2016.11918163 (2016).
19. Internet: <http://dx.doi.org/10.32628/IJSRSET20728> (2022).
20. Internet: <https://www.testresources.net/applications/test-types/fatigue-test/> (2022).
21. Nabeel Maqsood, Marius Rimašauskas, Characterization of carbon fiber reinforced PLA composites manufactured by fused deposition modeling, *Composites Part C: Open Access, Volume 4* (2021).
22. Vinayak C. Gavali, Pravin R. Kubade, Hrushikesh B. Kulkarni, Mechanical and Thermo-mechanical Properties of Carbon fiber Reinforced Thermoplastic Composite Fabricated Using Fused Deposition Modeling Method, *Materials Today: Proceedings, Volume 22, Part 4* (2020).
23. Travieso-Rodriguez, J.A. & Jerez-Mesa, Ramon & Llumà, Jordi & Traver, Oriol & Gómez-Gras, Giovanni & Josep, Joan & Rovira, Roa. (2019). Mechanical Properties of 3D-Printing Polylactic Acid Parts subjected to Bending Stress and Fatigue Testing. *Materials* (2019).
24. Azadi, Mohammad & Dadashi, Ali & Aghareb Parast, Mohammad Sadegh & dezhianian, Shokouh & Bagheri, Abbasali & Kami, Abdolvahed & Kianifar, Morteza & Asghari, Vahid. (2022). A Comparative Study for High-Cycle Bending Fatigue Lifetime and Fracture Behavior of Extruded and Additive-Manufactured 3D-Printed Acrylonitrile Butadiene Styrene Polymers (2022).
25. S. S. Rattan - *Strength of Materials*-Tata Mcgraw Hill (2011).

26. Internet: <https://whatispiping.com/guided-cantilever-method/> (2022).
27. Ayrilmis, Nadir, et al. "Use of wood in 3d printing technology-case Studies." Increasing the use of wood in the global bio-economy (2018).
28. Chen, Cheng & Wang, Xi & Wang, Yan & Yang, Dandan & Fangyi, Yao & Zhang, Wenxiong & Wang, Bo & Sewvandi, Galhenage & Yang, Desuo & Hu, Dengwei. (2020). Additive Manufacturing of Piezoelectric Materials. Advanced Functional Materials (2020).
29. Internet: <https://all3dp.com/2/3d-print-delamination-tips-tricks-to-avoid-layer-separation/> (2022).
30. Internet: <https://gulfnews.com/uae/government/dubai-to-build-worlds-first-3d-printed-office-1.1543159> (2022).
31. Ferraro, Alessandra & Pirozzi, Marco & Annacondia, Enrico & Donato, Luciano. (2020). Powder bed fusion/sintering machines: safety at workplaces. Procedia Manufacturing (2020).
32. Jiao, Lishi & Chua, Zhong & Moon, Seung & Song, Jie & Bi, Guijun & Zheng, H.Y.. (2018). Femtosecond Laser Produced Hydrophobic Hierarchical Structures on Additive Manufacturing Parts. Nanomaterials (2018).
33. Omiyale, Babatunde & Farayibi, P. K.. (2020). Additive manufacturing in the oil and gas industries. Analecta Technica Szegedinensia. 14. 9-18. 10.14232/analecta (2020).
34. Internet: <http://m.facfox3d.com/info/electron-beam-melting-ebm-3d-printing-simp-69487443.html> (2022).
35. Alomarah, Amer & Ruan, Dong & Masood, S. & Gao, Zhanyuan. (2019). Compressive properties of a novel additively manufactured 3D auxetic structure. Smart Materials and Structures (2019).
36. Kantaros, Antreas & Piromalis, Dimitrios. (2021). Employing a Low-Cost Desktop 3D Printer: Challenges, and How to Overcome Them by Tuning Key Process Parameters. International Journal of Mechanics and Applications (2021).
37. Janiszewski, Jacek & Płatek, Paweł & Dziewit, Piotr & Sarzyńska, Katarzyna. (2018). Issues of Designing and Testing Regular Cellular Structures Manufactured Using Additive Technologies. Problems of Mechatronics Armament Aviation Safety Engineering (2018).
38. Selema, Ahmed & Ibrahim, Mohamed & Sergeant, Peter. (2022). Metal Additive Manufacturing for Electrical Machines: Technology Review and Latest Advancements (2022).

39. Ransikarbum, Kasin & Pitakaso, Rapeepan & Kim, Namhun. (2020). A Decision-Support Model for Additive Manufacturing Scheduling Using an Integrative Analytic Hierarchy Process and Multi-Objective Optimization. *Applied Sciences* (2020).
40. Padash, Mahshid, Christian Enz, and Sandro Carrara. "Microfluidics by additive manufacturing for wearable biosensors: A review." *Sensors* 20.15 (2020).



## **RESUME**

Husam BAWADIKJI he completed high school education in MOUSA IBN NUSAYR High School, after that, he started undergraduate program in Aleppo University Department of Material Science and Engineering in 2011. Then in 2016 he was appointed as a lecturer at the University of Aleppo, Faculty of Mechanical Engineering, Department of Engineering Materials Science. In 2017, he enrolled in a master's degree at the Syrian Virtual University, a master's program in quality. In 2020, he enrolled in the University of Karabuk, Department of Metallurgical and Materials Engineering.