

AN EXPERIMENTAL USER EVALUATION STUDY: DIFFERENT  
APPLICATIONS OF OCCUPANCY SENSORS IN CIRCULATION AREAS

A THESIS SUBMITTED TO  
THE GRADUATE SCHOOL OF NATURAL AND APPLIED SCIENCES  
OF  
MIDDLE EAST TECHNICAL UNIVERSITY



BY

ÖZGE KARAMAN

IN PARTIAL FULFILLMENT OF THE REQUIREMENTS  
FOR  
THE DEGREE OF MASTER OF SCIENCE  
IN  
BUILDING SCIENCE IN ARCHITECTURE

JUNE 2019



Approval of the thesis:

**AN EXPERIMENTAL USER EVALUATION STUDY: DIFFERENT  
APPLICATIONS OF OCCUPANCY SENSORS IN CIRCULATION AREAS**

submitted by **ÖZGE KARAMAN** in partial fulfillment of the requirements for the degree of **Master of Science in Building Science in Architecture Department, Middle East Technical University** by,

Prof. Dr. Halil Kalıpçılar  
Dean, Graduate School of **Natural and Applied Sciences**

Prof. Dr. F. Cânâ Bilsel  
Head of Department, **Architecture**

Assist. Prof. Dr. Mehmet Koray Pekeriçli  
Supervisor, **Architecture, METU**

**Examining Committee Members:**

Prof. Dr. Gülser Çelebi  
Interior Architecture, Çankaya University

Assist. Prof. Dr. Mehmet Koray Pekeriçli  
Architecture, METU

Assoc. Prof. Dr. Ayşe Tavukçuoğlu  
Architecture, METU

Assoc. Prof. Dr. Ali Murat Tanyer  
Architecture, METU

Assoc. Prof. Dr. Çağla Doğan  
Industrial Design, METU

Date: 25.06.2019



**I hereby declare that all information in this document has been obtained and presented in accordance with academic rules and ethical conduct. I also declare that, as required by these rules and conduct, I have fully cited and referenced all material and results that are not original to this work.**

Name, Surname: Özge Karaman

Signature:

## **ABSTRACT**

### **AN EXPERIMENTAL USER EVALUATION STUDY: DIFFERENT APPLICATIONS OF OCCUPANCY SENSORS IN CIRCULATION AREAS**

Karaman, Özge

Master of Science, Building Science in Architecture

Supervisor: Assist. Prof. Dr. Mehmet Koray Pekerçli

June 2019, 116 pages

Lighting has a significant share in electricity consumption of buildings. In this regard, use of suitable control strategies are essential to provide energy efficiency. In terms of lighting control, occupancy sensors are highly promoted by the building codes being the most cost-effective systems in the sector, especially for buildings where the occupancy patterns are not steady. However, widespread use of these systems is still limited. In the literature where there are many studies on energy saving potentials of occupancy sensors, there is no comprehensive research on the assessment of user satisfaction. In this study it is hypothesized that, “conventional use” itself may be the problem behind this dissatisfaction. In the conventional use, user steps in a dark area, only after, this area becomes lit. Especially in night use, this may cause discomfort to the occupants. To overcome this problem, two user-centric occupancy sensor-based scenarios are proposed in this research where user steps in an already lit or dimly lit area. An experimental setup was built to test feasibility of these scenarios along with the conventional occupancy sensor scenario and existing “no sensor” scenario. In total four different lighting control scenarios were tested by each participant in a controlled environment. Evaluation on the user satisfaction, comparison on energy saving potentials of these scenarios are presented. Main results revealed that conventional use of occupancy sensors was not favored by

the participants in the night use. Use of proposed improved occupancy sensor scenarios (where participants stepped in already lit or dimly lit areas) were as favorable as the existing constantly lit situation. It is the claim of this study that both energy efficiency and user satisfaction can be provided in circulation areas in night use by the use of user-centric sensor-based lighting control systems. Widespread use of energy efficient lighting control systems can be possible.

**Keywords:** Energy Efficient Lighting Control, Occupancy-based Lighting Control, User Satisfaction, Energy Efficiency, Occupancy Sensors



## ÖZ

### **KULLANICI DEĞERLENDİRMESİ ÜZERİNE DENEYSEL BİR ÇALIŞMA: DOLAŞIM ALANLARI İÇİN VARLIK SENSÖRLERİNİN FARKLI UYGULAMALARI**

Karaman, Özge  
Yüksek Lisans, Mimarlık  
Tez Danışmanı: Dr. Öğr. Üyesi Mehmet Koray Pekerçli

Haziran 2019, 116 sayfa

Aydınlatma, binaların elektrik tüketiminde önemli bir paya sahiptir. Bu bağlamda, enerji verimliliği sağlamak için uygun kontrol stratejilerinin kullanılması esastır. Aydınlatma kontrolü açısından, varlık sensörlerinin kullanımı, özellikle kullanıcı trafiğinin sabit olmadığı binalarda, sektördeki en uygun maliyetli sistemler olmaları açısından yönetmeliklerce önerilmektedir. Ancak, bu sistemlerin yaygın kullanımı hala sınırlıdır. Varlık sensörlerinin enerji tasarrufu potansiyelleri üzerine olan literatürde, kullanıcı memnuniyetinin değerlendirilmesi konusunda kapsamlı bir araştırma yoktur. Bu çalışmada “geleneksel kullanımın” kendisinin bu memnuniyetsizliğin arkasındaki sorun olabileceği varsayılmaktadır. Geleneksel kullanımda, kullanıcı karanlık bir alana girer ve hemen ardından bu alan aydınlanır, ve bu durum rahatsızlık verebilir. Bu sorunun üstesinden gelmek için, bu çalışmada kullanıcının tam ya da yarı aydınlatılmış bir alana adım attığı, iki farklı kullanıcı merkezli varlık sensörü tabanlı senaryo önerilmiştir. Geleneksel varlık sensörü senaryosu ve mevcut “sensörsüz” sürekli aydınlık senaryosu ile birlikte bu önerilen senaryoların fizibilitesini test etmek için deneysel bir kurulum yapılmıştır ve dört farklı aydınlatma kontrol senaryosu kontrollü bir ortamda test edilmiştir. Kullanıcı memnuniyetinin değerlendirilmesi, senaryoların enerji tasarrufu

potansiyellerinin karşılaştırması sunulmaktadır. Ana sonuçlar, varlık sensörlerinin geleneksel kullanımının gece kullanımında katılımcılar tarafından tercih edilmediğini ortaya koymuştur. Önerilen geliştirilmiş varlık sensörü senaryolarının kullanımı mevcut sürekli yanan durum kadar elverişlidir. Bu çalışmanın iddiası, kullanıcı odaklı sensör tabanlı aydınlatma kontrol sistemlerinin kullanılmasıyla gece kullanımında dolaşım alanlarında hem enerji verimliliğinin hem de kullanıcı memnuniyetinin sağlanabileceğidir. Enerji verimli aydınlatma kontrol sistemlerinin yaygın olarak kullanılması böylece mümkün olabilir.

Anahtar Kelimeler: Enerji Verimli Aydınlatma Kontrolü, Kullanıcı Memnuniyeti, Varlık Tabanlı Aydınlatma Kontrolü, Enerji Verimliliği, Varlık Sensörleri

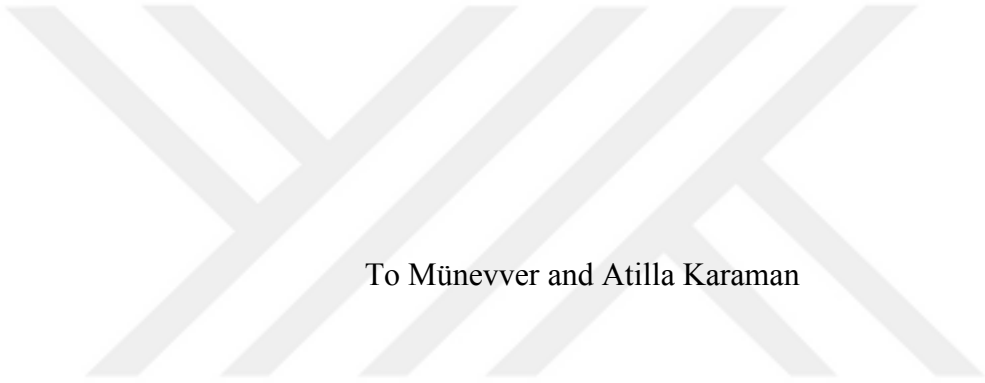

To Münevver and Atilla Karaman

## ACKNOWLEDGEMENTS

First, I would like to express my deepest gratitude to my supervisor Assist. Prof. Dr. Koray Pekerçli, for his guidance and support throughout this study. His endless positive energy was not only the source of encouragement for this study the but an inspiration for life.

Besides, I would like to thank to the members of the examining comitee: Assoc. Prof. Dr. Ali Murat Tanyer, Assoc. Prof. Dr. Ayşe Tavukçuoğlu and Assoc. Prof. Dr. Çağla Doğan for their valuable comments. I would also like to thank to Prof. Dr. Gülser Çelebi not only for her valuable contribution during the examination, but also for being a great inspiration and a role model for my academic career.

I would also like to thank sincerely to Res. Assist. Ozancan Özdemir, for his welcoming attitude and valuable guidance when I was lost in statistics.

I would like to thank my friend Burcu Eryılmaz for being an awesome thesis buddy and bringing joy to this journey; Gizem Özban for her endless support in the process and trustful friendship; Gamze Güngör, İnci Kasım and Kübra Kutay for their physical and emotional support and beautiful friendship no matter what the time/place is; Nur Özkan and Yeliz Aksu for being there for me when I needed; at last I would like to thank Melisa Çilli, for just being who she is and being it in my life.

I would like to thank to my beautiful mother Münevver Karaman for her endless belief in me and my father Atilla Karaman for his endless support and love. They made me be the best version of myself. I would also like to thank my grandparents Zahide-Muhittin Karaman, Sabiha-Bahri Toktay and all other family members for their love and sympathy forever.

Finally, I am grateful for my beloved Alican Madan for his physical and emotional support when I needed the most, without him it would not be possible. I am truly grateful that we are sharing a life together.

## TABLE OF CONTENTS

|   |     |
|---|-----|
| ABSTRACT .....  | v   |
| ÖZ .....  | vii |
| ACKNOWLEDGEMENTS .....                                  | x   |
| TABLE OF CONTENTS .....                                 | xi  |
| LIST OF TABLES .....                                    | xiv |
| LIST OF FIGURES .....                                   | xv  |
| CHAPTERS  |     |
| 1. INTRODUCTION .....                                   | 1   |
| 1.1. Background Information .....                       | 1   |
| 1.2. Aim and Objectives .....                           | 4   |
| 1.3. Contribution.....                                  | 5   |
| 1.4. Disposition.....                                   | 6   |
| 2. LITERATURE REVIEW .....                              | 7   |
| 2.1. Lighting Quality .....                             | 7   |
| 2.2. Lighting Design Process.....                       | 11  |
| 2.3. Lighting Control .....                             | 15  |
| 2.3.1. Lighting Control Strategies.....                 | 18  |
| 2.3.2. Selection of Lighting Control Strategies .....   | 23  |
| 2.4. Occupancy Based Lighting Control Technologies..... | 25  |
| 2.4.1. Factors Affecting the Performance .....          | 32  |

|   |    |
|---|----|
| 2.4.2. Recent Studies on Occupancy Based Lighting Control ..... | 35 |
| 3. MATERIAL AND METHOD.....                                     | 43 |
| 3.1. Research Problem and Research Questions .....              | 43 |
| 3.2. Study Design .....   | 45 |
| 3.3. Participants.....  | 45 |
| 3.4. Experiment Area .....                                      | 46 |
| 3.5. Experimental Setting.....                                  | 49 |
| 3.5.1. Setting.....   | 49 |
| 3.5.2. Experimental Scenarios .....                             | 50 |
| 3.5.3. Material Selection and Application .....                 | 53 |
| 3.5.4. Controlling the experimental scenarios.....              | 58 |
| 3.6. Procedure .....  | 59 |
| 3.7. Measures .....   | 60 |
| 3.7.1. Evaluation of the scenarios.....                         | 60 |
| 3.7.2. Energy Saving Potentials.....                            | 62 |
| 3.8. Analysis.....  | 63 |
| 4. RESULTS AND DISCUSSION .....                                 | 65 |
| 4.1. Comparison of the Energy Saving Potentials .....           | 65 |
| 4.2. Overall Satisfaction Scores .....                          | 68 |
| 4.3. Evaluation of the Scenarios.....                           | 70 |
| 4.3.1. Scenario A .....   | 71 |
| 4.3.2. Scenario B .....   | 72 |
| 4.3.3. Scenario C .....   | 73 |
| 4.3.4. Scenario D .....   | 74 |

|   |     |
|---|-----|
| 4.4. Comparison of the Evaluation Criteria.....                   | 75  |
| 4.4.1. Outside Atmosphere .....                                   | 75  |
| 4.4.2. Outside Mood .....   | 76  |
| 4.4.3. Well-being .....   | 77  |
| 4.4.4. Visual Comfort .....                                       | 78  |
| 4.4.5. Mood Inside .....  | 79  |
| 4.4.6. Atmosphere Inside .....                                    | 80  |
| 4.4.7. Visibility .....   | 81  |
| 4.4.8. Appraisal.....   | 82  |
| 4.4.9. Acceptance.....  | 83  |
| 4.4.10. Sense of security .....                                   | 84  |
| 4.4.11. Discussion.....   | 85  |
| 5. CONCLUSION.....  | 87  |
| 5.1. Summary of the Research.....                                 | 87  |
| 5.2. Main Results and Discussions .....                           | 89  |
| 5.3. Limitations of the Study .....                               | 90  |
| 5.4. Recommendations for Further Research .....                   | 92  |
| REFERENCES.....   | 95  |
| APPENDICES  |     |
| A. Detailed Information on the Participants .....                 | 103 |
| B. Consent Participation Form .....                               | 104 |
| C. Evaluation Questionnaire Form .....                            | 105 |
| D. Results of the Friedman Test for 'Overall Liking Scores' ..... | 106 |
| E. Results of the Friedman Test for 'Evaluation Criteria' .....   | 107 |

## LIST OF TABLES

### TABLES

|   |    |
|---|----|
| Table 2.1. Relation between age and relative amount of light required for reading good print (van Bommel & van den Beld, 2004). .....   | 12 |
| Table 2.2. Three basic components of a lighting control system (DiLouie, 2008). ..  | 17 |
| Table 2.3. Table showing the lighting control strategies and their brief definitions (Benya, Heschong, McGowan, Miller, & Rubinstein, 2003; DiLouie, 2008; Walerczyk, 2014; Williams, Atkinson, Garbesi, Page, & Rubinstein, 2012)..... | 19 |
| Table 2.4. Comparison on occupancy sensing technologies (Guo et al., 2010).....   | 31 |
| Table 2.5 Effects of time delay, sensitivity and coverage area on occupancy sensor performance (M. A. ul Haq et al., 2014). .....   | 33 |
| Table 2.6 Savings from hybrid occupancy-based systems in the literature (Haq et. al., 2014). .....  | 35 |
| Table 2.7. Control table showing the summary of the main actions of the control system (Nagy et al., 2015). .....   | 40 |
| Table 3.1. Brief explanation of the lighting control scenarios. ....  | 51 |
| Table 3.2. Lighting control principles shown schematically for each scenario.....   | 51 |
| Table 3.3. Materials used for the experiment. ....  | 57 |
| Table 3.4. Evaluation questionnaire. ....   | 62 |

## LIST OF FIGURES

### FIGURES

|  |    |
|--|----|
| Figure 2.1. Figure showing the affecting factors of lighting quality (IESNA, 2000).  | 8  |
| Figure 2.2. Human needs served by lighting (IESNA, 2000).  | 8  |
| Figure 2.3. Sleepiness and well-being change during 2-h light at 6500K, 2500K and 3000K (Chellappa et al., 2011).  | 10 |
| Figure 2.4. Relation between age and relative amount of light required for reading good print (van Bommel & van den Beld, 2004).   | 11 |
| Figure 2.5. Ambient daylight is used to complement existing lighting in a room (Chew <i>et al.</i> 2017).  | 21 |
| Figure 2.6. Figure showing a scheduling example from a weekday of an office building (DiLouie, 2005).  | 22 |
| Figure 2.7. Occupancy sensor control scheme (Benya et al., 2003).  | 26 |
| Figure 2.8. Occupancy control algorithm (Delaney et al., 2009).  | 27 |
| Figure 2.9. Figure showing the typical field of view of a wall mounted PIR sensor (Guo, Tiller, Henze, & Waters, 2010b).   | 28 |
| Figure 2.10. Figure showing the typical pattern of a wall mounted ultrasonic sensor (Benya et al., 2003).  | 29 |
| Figure 2.11. Patterns of Wall mounting and ceiling mounting patterns. Retrieved in 5 May 2019 from <a href="http://www.light.fi/blog/microwave-sensors-utilize-lighting/">http://www.light.fi/blog/microwave-sensors-utilize-lighting/</a> . | 30 |
| Figure 2.12. Figure showing the potential savings from different rooms by different time delay settings (Richman et al., 1996).  | 34 |
| Figure 2.13. Basic operating principle of the system (Byun <i>et al.</i> , 2013).  | 37 |
| Figure 2.14. Model for the light control in corridor type spaces (Byun & Shin, 2018).  | 38 |
| Figure 2.15. Figure showing the 9 lighting scenarios tested in a controlled environment (de Bakker et al., 2018).  | 39 |

|  |    |
|--|----|
| Figure 3.1. Upper Ground Floor Plan of the METU FA (plan drawn by Özgür Ürey).   | 47 |
| Figure 3.2. Experiment area in daytime (Viewpoints are given on the plan).   | 48 |
| Figure 3.3. One of the existing CFLs in the experiment area.   | 48 |
| Figure 3.4. Plan denoting the location of zones, luminaires, sensors and controllers.  | 50 |
| Figure 3.5. Inside of the control room (a), cables going into control room (b), control point in the control room (c).               | 54 |
| Figure 3.6. Setting of the luminaires.   | 54 |
| Figure 3.7. Plugs of the 6 lines of luminaires.  | 55 |
| Figure 3.8. Setting of the microwave sensor.   | 56 |
| Figure 3.9. Plugs of the sensors (3 female plugs for connection to the line of luminaires, 3 male plugs for connection to the grid). | 56 |
| Figure 3.10. All connections by the sensors and line of luminaires (Male and female plugs are depicted schematically).               | 58 |
| Figure 3.11. Procedure of the experiment.  | 60 |
| Figure 4.1. Annual energy consumption of the experimental scenarios.   | 67 |
| Figure 4.2. Median and range of overall satisfaction scores on 4 experimental lighting control scenarios (N=37).                     | 69 |
| Figure 4.3. Median scores of the evaluation of Scenario A (N=37).  | 71 |
| Figure 4.4. Median scores of the evaluation of Scenario B (N=37).  | 72 |
| Figure 4.5. Median scores of the evaluation of Scenario C (N=37).  | 73 |
| Figure 4.6. Median scores of the evaluation of Scenario D (N=37).  | 74 |
| Figure 4.7. Median scores for ‘Outside Atmosphere’.  | 75 |
| Figure 4.8. Median scores for ‘Mood Outside’.  | 76 |
| Figure 4.9. Median scores for ‘well-being’.  | 77 |
| Figure 4.10. Median scores for ‘visual comfort’.   | 78 |
| Figure 4.11. Median scores for ‘mood inside’.  | 79 |
| Figure 4.12. Medians scores for ‘inside atmosphere’.   | 80 |
| Figure 4.13. Median scores for ‘visibility’.   | 81 |

Figure 4.14. Median scores for ‘appraisal’ .....82  
Figure 4.15. Median scores for ‘acceptance’ .....83  
Figure 4.16. Median scores for ‘sense of security’ .....84  
Figure 4.17. Spider chart representing the evaluation criteria in terms of experimental scenarios.....85





## CHAPTER 1

### INTRODUCTION

In this chapter, firstly background information on the research topic is presented and motivation of this study is highlighted. Then aim and objectives of the study are stated. Finally, contribution to the literature is overviewed and the disposition of the thesis is outlaid.

#### **1.1. Background Information**

According to Maslow's hierarchy of needs, the basic needs of a human being are physiological and safety needs (Maslow, 1943). From antiquity to modern day, although the way of living has drastically changed, these basic needs have remained valid. Starting from an ancient cave to modern building, dwellings stand in a crucial position on fulfillment of these basic needs, as this fulfillment is the simple largest motivator of architecture itself.

Before the industrial revolution, architecture was dependent on local resources and construction techniques that are constrained by limited knowledge and technology. The building (primarily its envelope) was a separator between exterior conditions and the interior. Thermal and visual environment was controlled by the building envelope with supplemental heat as a fireplace and supplemental illumination as candles or oil lamps (Moore, 1993). After the industrial revolution, with the innovative technologies and techniques, much has changed. By the invention of electric lighting, mechanical heating and cooling; the envelope has become a representative esthetic object to exclude water and wind. Thinner walls and larger glass surfaces were used. Deeper spaces with lower ceilings were now possible without the restraint of the light provider façades. This new architecture which was now liberated from climate, resulted with an excessively increased energy usage as a payoff. Energy was cheap and abundant;

therefore, detrimental effects were neglected until the oil embargo in 1973 (Brox, 2010). With the rising costs and shortage, an awakening has begun, and energy conservation became a center of interest by governments and professionals. On the building research, starting from the end of 1950s (with a concept of 'bioclimatic architecture' by Olgyay brothers) until today, environmentally friendly and energy efficient building has become a hot topic. With this turnabout to climate dependent architecture, the concerns in the sector and building research was raised upon ways of reducing the energy use in buildings. Renewable energy production and use is promoted, better insulation materials for building envelope are introduced and energy efficient systems are investigated with new products.

In the case of lighting, electric light has now been in existence for nearly 100 years. Since then, several different types of luminaires had been invented with focusing more and more energy efficiency and lighting quality. With the evolution of these products, several lighting control technologies were also introduced to the market. Researchers have been working on energy savings by lighting controls in buildings for more than 30 years (Williams et. al., 2012). Lighting is responsible for a significant share of energy consumption in buildings. In particular, according to data published by U.S Department of Energy (DOE) in 2012, in commercial buildings lighting on its own constitutes almost 20% of the total energy consumption (DOE, 2012). According a report published in 2018 by Turkish Ministry of Energy and Natural Resources, lighting is responsible for 25% of all energy use (leading share of consumption) in university buildings (YEGM, 2018). According to strategic goals of energy efficiency total energy consumption of all public buildings should be decreased by at least 20% (from the rates of 2010) until 2023 (YEGM, 2018). It is recommended by the same report to use more efficient products and modernized lighting control systems that are integrated with the building automation to achieve this goal in the share of lighting energy use. Today, several energy saving control technologies are on the market to achieve maximum energy efficiency in lighting. With the implementation of sensor

based control systems, the lighting energy consumption has reduced from 10% to %90 depending on area of use (DOE, 2016).

On the other hand, effects of lighting on human physiology and psychology is still a hot topic in the literature. It is proven that lighting has a direct impact on human's biological clock (circadian rhythm). While in terms of circadian rhythm, day time and night time are dedicated to specific tasks as work in daytime and recreational activities and sleep at dark hours, individuals may choose to work in dark hours in terms of personal preferences (Barton, 1994). In case of these people that are having flexible working and studying hours, some kind of buildings (such as university buildings, research centers, offices *etc.*) are subjected to 24 hours of occupation a day. Special emphasis has been given to dark hours, these buildings' occupancy patterns in circulation areas may be subjected to huge differences. In the night use of circulation areas, manual control of lighting may cause inefficiencies in energy use. To have better energy efficiency, occupancy sensors are promoted by the energy codes. However, common use of occupancy sensors in conventional ways (*i.e.*, user steps inside, sensor activates and energizes the luminaires in that area) for lighting control in circulation areas may cause dissatisfaction by the participants, particularly in nights use.

Late triggering of the sensor, false on and off or inappropriate delay time may cause dissatisfaction in the conventional use of an occupancy sensor, but these problems can be overcome by better quality products or better commissioning. Rather than these problems, as researchers observed, stepping into a dark area may cause dissatisfaction by the occupants at night use. Byun and Shin (2018) also addressed to that problem in their research and proposed a sensor based lighting control system where all area is dimly lit to prevent occupants stepping into a dark environment. When presence is detected area is fully lit. While this research makes a valuable contribution to the issue, it lacks giving a comprehensive result in terms of user satisfaction. Moreover, researchers also estimate having dark spots in the sight of view might be another

reason causes dissatisfaction in the use of conventional use of occupancy sensor in circulation areas at the night use.

In the literature there are a lot of researches on energy efficiency of different types of systems, sensors, and luminaires. These researches are based on quantification of energy efficiency. Back to basics, it is essential to remember that physiological needs and safety needs of buildings' occupants are as important as energy efficiency in buildings. In terms of sustainable development, the assessment of energy improvement systems is essential in order to be accepted by the users. Buildings are responsible for providing comfort, sense of security and well-being to its occupants. A well-designed lighting control system is one of the main requirements to ensure these criteria. In the literature, there are few studies on user acceptance of sensor-based lighting control systems. However so far there is no comprehensive research on the issue. Especially in buildings that are occupied 24 hours a day, the design of the lighting control systems is important to provide user satisfaction without sacrificing the energy efficiency. Focusing on these kinds of buildings, this research focuses on different lighting control scenarios with occupancy sensors in night use to evaluate user satisfaction.

## **1.2. Aim and Objectives**

The aim of this study is to contribute to the developments in energy efficient sensor-based lighting control systems by presenting findings on user evaluation by different sensor-based lighting control scenarios (based on different combinations of sensors and zone of luminaires), focusing on night use in circulation areas.

To achieve this aim, research objectives can be listed as:

- Comparing existing lighting control system and experimental occupancy sensor-based lighting control systems in an experimental setup;
- Experimenting the effects of different combinations of occupancy sensors and zone of luminaires (different triggering scenarios) on user satisfaction;

- Investigating the effects of having lit, semi lit and dark areas in the sight of view on user satisfaction in circulation areas of night use;
- Investigating the effects of stepping into lit, semi lit and dark areas on user satisfaction in circulation areas of night use;
- Comparing these lighting control scenarios in terms of energy efficiency and initial cost of applications;
- Presenting results on different evaluation criteria and compare these criteria in terms of experimented lighting control scenarios.

### **1.3. Contribution**

In the literature, the relationship between energy efficiency and user comfort in buildings has gained a lot of importance recently. There are various studies based on sensor-based lighting control systems in the literature. Majority of these research is on energy efficiency and there are few recent studies on user satisfaction. In these recent studies on user satisfaction, effect of time delay and effect of minimum/maximum level of illuminances in vacancy/occupancy situations are tested in terms of user satisfaction. However, there is no particular study on different combinations and different triggering scenarios of sensors and zone of luminaires in terms of user satisfaction in circulation areas. And there is also no particular research on the evaluation of sensor-based lighting control systems in night use which is believed to be critical for occupants. The contribution of this study is to present a user satisfaction and energy efficiency analysis on the sensor-based lighting control systems in circulation areas of a university building (occupied for 24 hours) in the night time use. Conventional use of occupancy sensors will be examined to test the research questions and proposed scenarios to overcome possible reasons of dissatisfaction (stepping inside of a dark area and having dark spots in the sight of view).

#### **1.4. Disposition**

This thesis is composed of five chapters. In the first chapter, a background information on the issue is presented with the motivation of the study. Aim and objectives are outlaid, contribution to the literature is highlighted and disposition of the thesis is given. In Chapter 2, a literature review is presented by necessary knowledge on quality lighting, lighting design, lighting control, lighting control strategies, lighting control technologies and occupancy sensors. Recent studies on the research topic is also presented in this section with the critical analysis of the literature. In the Chapter 3, research problem and research questions are presented, material and method of the study is outlaid. Chapter 4 reveals the results of this study and presents the discussion. Finally, in Chapter 5, a conclusion is driven with the main findings, limitations and future research directions.

## CHAPTER 2

### LITERATURE REVIEW

In this chapter, the literature knowledge on the topic is presented. Firstly, lighting quality and its parameters are outlined. Secondly, information on lighting design process is given. Then, lighting control and lighting control strategies are overviewed. Following that, existing lighting control technologies are presented, and occupancy sensors are examined in detail. Finally, recent studies on sensor-based lighting control systems are presented with a critical analysis of the literature.

#### 2.1. Lighting Quality

“A lighting design is the specification of a system of luminaires and controls to create illumination appropriate to a given environment” (Stiller, 2013, p. 3). In IESNA Lighting Handbook, the elements of a high-quality lighting design are given by the figure below (Figure 2.1). According to Figure 2.1, lighting quality depends on human centered, architectural, and economical/environmental factors. To create a built environment that satisfies the needs of the occupants, that does not harm environment/budget and enhance architectural quality, an integrated design process is needed between building design, interior design and lighting design (Stiller, 2013).

As seen in the Figure 2.1, human needs are one of the main elements of lighting quality along with architecture, economics and the environment. Lighting influences emotions, actions, perceptions, and health (IESNA, 2000). Figure 2.2 shows the human needs served by lighting from IESNA Lighting Handbook 9<sup>th</sup> Edition. Visibility is the center element to fulfill other criteria: task performance, mood and atmosphere, visual comfort, aesthetic judgment, health, safety, and well-being, and social communication.

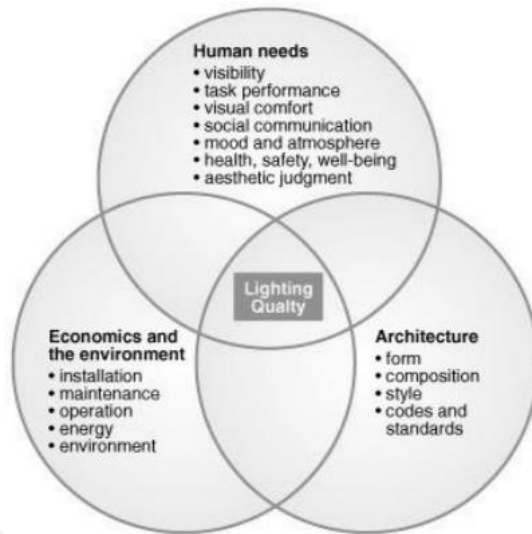

Figure 2.1. Figure showing the affecting factors of lighting quality (IESNA, 2000).

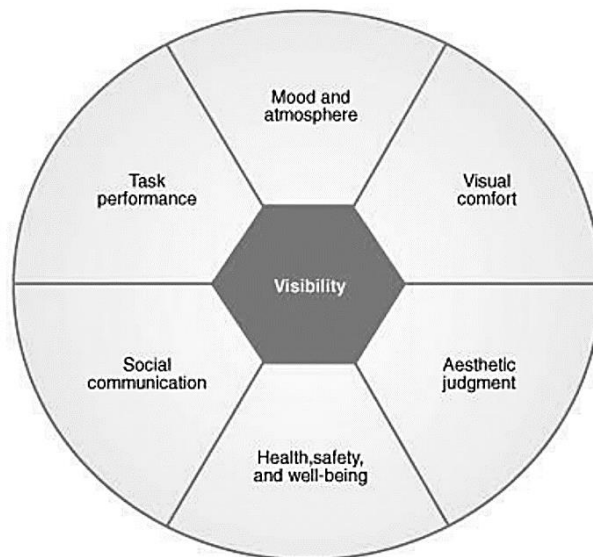

Figure 2.2. Human needs served by lighting (IESNA, 2000).

These elements will be summarized here to deduce necessary information from the handbook. Visibility is influenced by the size, contrast and luminance of an object and age and visual skills of a subject. Task performance refers to any activity of a user.

Lighting should ensure users to perform intended activity. Mood and atmosphere stand for the emotional response including preference, satisfaction, relaxation, and stimulation. Visual comfort has influence on task performance, health and safety and mood and atmosphere and depends on the type of task being performed. Aesthetic judgment is another criterion served by lighting since lighting can enhance any visual element and communicate information. Health, safety and well-being are the primary concerns of lighting and often associated with other needs of lighting such as visibility, task performance and mood and atmosphere. Finally, social communication need refers to necessary amount of illumination to conduct communication since most interactions are based on non-verbal communications (IESNA, 2000).

There is a lot of research in the literature on lighting-user relationship by different aspects. The importance of lighting on human body and mind is being studied extensively in biology and medical science for almost 40 years (van Bommel & van den Beld, 2004). With the discovery of a photoreceptor in the retina, it is known that the effects of lighting are not just limited with the visual comfort, but has direct influence on human biology by modulating our biological clock (circadian rhythm) (Berson, Dunn, & Takao, 2002).

Research shows that, the quality of work environment has a significant impact on performance, health and well-being of office occupants (Vimalanathan & Babu, 2014). The quality of working areas is affected by several factors. Good quality lighting is one of the primary factors determining occupant comfort which supports visual performance, social communication and improves sense of well-being (IESNA, 2000). It ensures users to feel safe and pleased with aesthetic components (Winchip, 2011). The quality of lighting has a great impact on health, wellbeing, core body temperature, alertness and sleep quality (van Bommel & van den Beld, 2004).

Research shows that physiological effects of light are not derived from just illuminance but also from the correlated color temperature (CCT) and spectral composition (Borisuit, Linhart, Scartezzini, & Münch, 2015). Figure 2.3 shows the

results of a study carried on with 16 participants in a real setup with different luminaires (6500K,3000K,2500K) for 2 hours. According to this results, the cooler the light gets, the alertness and well-being increases, while sleepiness decreases (Chellappa et al., 2011). Another research also shows that CCT has an impact on thermal regulation and perception of air quality in indoor working environments (Chou, Lu, & Huang, 2016).

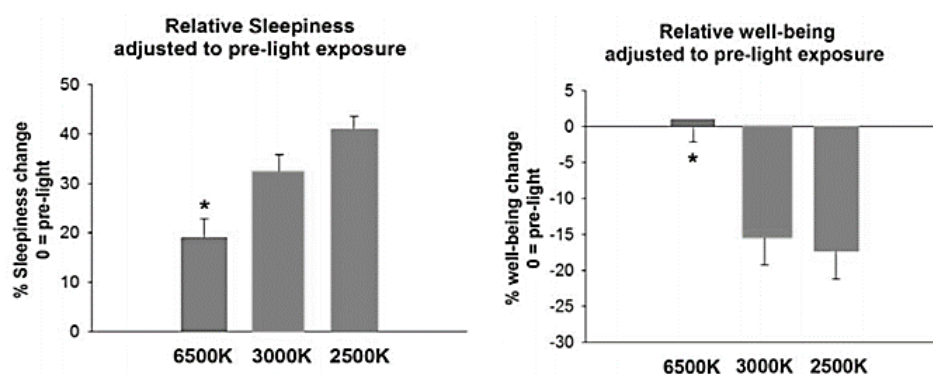

Figure 2.3. Sleepiness and well-being change during 2-h light at 6500K, 2500K and 3000K (Chellappa et al., 2011).

Another influencing factor of human comfort in working areas is daylight. Research shows that when properly controlled, daylight has a positive influence on visual performance, working environment and also on mood and stimulation by its dynamic and varying character in intensity and color (van Bommel & van den Beld, 2004). Van Bommel and van den Beld (2004) also mention in their study: “Bluish morning light has biologically an activating (alerting) effect, while the red sky that we see more often in the early evening, has a relaxing effect.” (p. 264). The authors continue with suggesting that, for occupant comfort in an office, both alerting and relaxing environments are needed (van Bommel & van den Beld, 2004).

The fact that all occupants are unique, and the visual performance does not depend on lighting itself but occupants’ seeing (visual) abilities. In Figure 2.4, it can be observed that age has an important role on visual performance. At this point, Korte *et al.*

suggested that while in an office environment there are adjustable settings for diverse human ergonomics, the environmental needs such as lighting, are not adjustable for individual occupant needs (de Korte *et al.*, 2015).

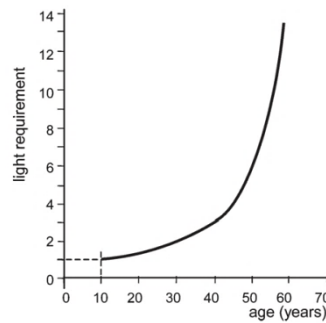

Figure 2.4. Relation between age and relative amount of light required for reading good print (van Bommel & van den Beld, 2004).

## 2.2. Lighting Design Process

A good lighting design requires a rational, professional and efficient designing process while as in any kind of design problem, there is no single solution or specific procedure to follow to design a lighting system. Every professional lighting designer would follow his/her own process by experience. Karlen and Benya (2012), proposes a sequential design process in their book *Lighting Design Basics* to present a start point and a guideline to designers. Below these steps will be summarized:

### ***Step 1: Determine lighting design criteria***

- Quantity of illumination

Table 2.1 shows the standard illuminance values recommended in *IESNA Lighting Handbook 9th edition* for different types of areas.

Table 2.1. Relation between age and relative amount of light required for reading good print (van Bommel & van den Beld, 2004).

| Category | Task  | Recommended illumination level |
|----------|---|--------------------------------|
| A        | Public spaces   | 30 lx                          |
| B        | Simple orientation for short visits   | 50 lx                          |
| C        | Working spaces where simple visual tasks are performed  | 100 lx                         |
| D        | Performance of visual tasks of high contrast and large size   | 300 lx                         |
| E        | Performance of visual tasks of high contrast and small size, or visual tasks of low contrast and large size | 500 lx                         |
| F        | Performance of visual tasks of low contrast and small size  | 1000 lx                        |
| G        | Performance of visual tasks near threshold  | 3000 to 10000                  |

- Quality of illumination
  - Appearance of the space
  - Lighting color quality
  - Day lighting
  - Glare control
  - Distribution of light on task area and other surfaces
  - Modeling of objects
  - Location of luminaries
  - Control of shadows
  - Providing flexibility

- Codes
  - Electric codes
  - Building codes
  - Energy codes
  - Accessibility codes
  - Health codes

***Step 2: Record architectural conditions and constraints***

- Size and locations of the windows
- Availability and size of plenum spaces
- As-built drawings
- Information gathered on problems and necessities (by managers and personnel)

***Step 3: Determine visual functions and tasks***

- Deciding on type of lighting needed for visual functions and tasks to be served
- Choose the category of lighting from Step 1 to determine illumination levels

***Step 4: Select lighting systems to be used***

- Location of luminaires
- Directed or diffused light
- Visible or hidden light source

***Step 5: Select luminaire and lamp types***

- Shape and size of the luminaires and details of construction
- Style, materials and color of the luminaires (compatible with architectural elements)
- Lamp qualities in terms of cost, lifetime and energy use

### ***Step 6: Determine Number and Location of Luminaires***

- Determination on quantity of each type of luminaire
- Placement of luminaires

### ***Step 7: Place Control Devices***

- Examine traffic paths and function of the room to guide for the placement of the control devices

### ***Step 8: Aesthetics and Other Intangibles***

Assessment of the previous steps by the view of psychology of the users and aesthetics, which are affected by:

- Size and scale
- Materials and finishes
- Design quality
- Ambiance
- Sculptural quality

After these steps, a final procedure should be carried on for the assessment of the lighting design project by visiting, observing the actual project area and discussing with users. This process is called Post Occupancy Evaluation (POE) (Karlen & Benya, 2012).

There are different strategies followed for new buildings and retrofit projects (existing buildings). According to IESNA Lighting Handbook 9th Edition (2000), determining the energy efficient changes in existing buildings is more accurate since it is possible to investigate space by usage and occupancy. The steps to be followed are presented above. In the case of new buildings, the lighting design is integrated with the overall design of the building in the early design phase and decisions on lighting may

influence the overall design of the building (Karlen & Benya, 2012). Rather than that, steps to be followed is still valid.

### **2.3. Lighting Control**

In her book *Brilliant*, Jane Brox (2010) explains the evolution of artificial light and lighting control strategies: Evolution of lighting control systems can be traced back to 1800s when the gas lamp was first introduced and used with a piped network system in the streets and residences. The light fixture was connected to these pipes and could be controlled by gas permitting valves and manual flaming. When electric bulb was invented and applied, these pipes were used as conduits for delivering the electricity via wires and gas lamp fixtures were replaced by electric bulbs. The simple switch on/off system as it is still in use now, invented and evolved this way.

According to a research on the evolution of lighting control systems over the past decade, there are 3 main transformations in the lighting industry that describe the evolution of the lighting control systems:

- The development of LEDs (permitting easy combination with micro controllers, allowing dimming control without sacrificing the lifetime, rendering different light color choices)
- The emergence of smart lighting systems (new opportunities and applications with reduced sensor costs)
- The emergence of IoT based connected building eco-systems (lighting data combined with other building system) (A Pandharipande & Newsham, 2018).

The energy efficiency and the visual quality of lighting systems are identified by the selection and design of luminaires, architectural organization and the lighting control systems (Wang, 2010, p. 207). According to Wang (2010, p. 207), a lighting control system should correspond typically the following requirements:

- functional use of an area
- visual comfort for the users
- energy efficiency
- convenience for the legislations
- creating an ambiance.

by providing,

- requested amount of light,
- where it is needed,
- when it is needed (DiLouie, 2008).

Considering the performed task, giving flexibility according to different situations and reducing the energy use are the factors to evaluate the right amount of light. Establishing control zones and controlling lighting according to these zones gives permission to give light where it is needed. Strategies to ensure light being served only in occupied time intervals ensures energy efficiency and also user comfort. Another purpose of lighting control is to meet buildings energy codes and legislations (Rundquist, McDougall & Benya, 1996).

A lighting control system is technically composed of three components (Table 2.2); sensing device (receives information), logic circuit (interprets the coming information and decides how to react) and power controller (operates the lighting system) (DiLouie, 2008).

Table 2.2. Three basic components of a lighting control system (DiLouie, 2008).

| <i>Component</i> | <i>Sensing Device</i> →               | <i>Logic Circuit</i> →                           | <i>Power Controller</i>                   |
|------------------|---------------------------------------|--|---|
| Function         | Provides information to logic circuit | Decides whether to supply lighting, and how much | Changes the output of the lighting system |

There are a lot of benefits can be obtained by the lighting controls. A well designed and effective lighting control system;

- eliminates energy waste,
- reduces utility costs (by reducing energy consumption and demand),
- increases worker productivity,
- prevents pollution by reduced use of electricity,
- provides space flexibility,
- improves aesthetics and image,
- provides appropriate mood settings,
- increases security,
- decreases maintenance operations,
- improves well-being of the occupants (DiLouie, 2005).

Lighting control (daylight control and electric lighting control) has a significant importance on energy efficiency in buildings and great potentials to improve user comfort. The question is that, to what extend users are willing to control their light to what level of intervention.

There are several studies revealed on user attitudes on controlled office lighting. Boyce *et al.* conducted an experiment to reveal the effects of variations in lighting quality (2006). Research shows that individually controllable lighting conditions and among them especially tunable controls were rated as being more environmentally

satisfactory and leading better productivity (Boyce et al., 2006). Another study shows that offering a default system settings and letting users control their light in order to their preferences has an important impact on user behavior (de Korte et al., 2015). The same study reveals that when arranging the pre-set values, higher default system settings resulted in higher use of illuminance by individual control while lower default system settings resulted in lower use of illumination by individual control. So it is recommended by the authors to offer lower pre-set values to have energy efficiency (de Korte et al., 2015). Shen *et al.* suggest that, in order to have an optimal control on user comfort and have a better energy efficiency, shading and lighting systems cannot be considered separately and while this problem addresses to integrated control systems (share of control information), the benefits of such systems have not been quantified (Shen, Hu, & Patel, 2014).

### **2.3.1. Lighting Control Strategies**

There are central and local lighting control strategies. In general, combination of both are used to achieve efficient lighting control systems. Central lighting control systems makes it possible to monitor and control the total energy use of the buildings. Moreover, peak demand can be detected and reduced (IESNA, 2000).

There are several lighting control strategies proposed in the literature and used in the sector by different lighting control technologies regarding different control devices. Table 2.3 is showing these strategies which are based on personal tuning, occupancy, daylight, scheduling, task tuning and demand control. Brief definition of these strategies is also given in the table.

Table 2.3. Table showing the lighting control strategies and their brief definitions (Benya, Hescong, McGowan, Miller, & Rubinstein, 2003; DiLouie, 2008; Walerczyk, 2014; Williams, Atkinson, Garbesi, Page, & Rubinstein, 2012).

| Strategy                            | Definition   |
|-------------------------------------|--|
| <b><i>Personal Tuning</i></b>       | Adjustment of the light levels manually by individuals                       |
| <b><i>Occupancy</i></b>             | Adjustment of the light levels automatically in terms of presence or vacancy |
| <b><i>Daylight-linked</i></b>       | Adjustment of the light levels in terms of presence and amount of daylight   |
| <b><i>Scheduling</i></b>            | Adjustment of light levels in schedule in terms of hours of occupation       |
| <b><i>Task Tuning</i></b>           | Adjustment of light levels for task and space specific needs                 |
| <b><i>Demand Control</i></b>        | Adjustment of light levels in order to reduce peak demand                    |
| <b><i>Adaptive Compensation</i></b> | Adjustment of light levels for night preferences by dimming devices          |

### ***Personal Tuning Strategies***

Personal tuning strategies refer to arrangement of light levels individually by the occupants according their personal preferences (Williams *et al.* 2012). Occupants can control their lights through various types of switching systems. Multilevel switching and manual dimming systems are 2 of the commonly used manual control systems on lighting. As well as, basic wall mounted control switches, computer-controlled systems and wireless smart phone applications are on the market today to give occupants control over their light level and lighting parameters.

*Research shows* that, giving a user ability to achieve preferred lighting conditions by individual dimming control, increases the visual comfort and satisfactory (Boyce *et al.* 2006). On the other hand, individual control is not likely to be used unless there is a strong visual discomfort and once set by the user generally remain untouched (Boyce *et al.* 2006). That may cause serious energy waste through redundant lighting.

Efficiency of these manual control systems depends mostly on the occupant awareness.

In residents, occupants tend to turn off their lights when they are not needed due to mostly economic consequences. On the other hand, in non-residential buildings, since occupants are not responsible for the bills they tend to leave lights on when they are leaving a room. The manual control systems are most likely to be successful when occupants feel a place attachment with the area (Walerczyk, 2014). In private offices, manual controls are effective in terms of energy efficiency, but due to lack of place attachment, in common areas occupants do not give much attention to lighting control. This requires the use of automated lighting control systems to avoid excess use of energy.

### ***Occupancy Based Strategies***

Occupancy based strategies refer to control lighting in an area according to presence/vacancy of its occupants. Areas with discontinued and dynamic occupancy patterns are best suitable for applications of occupancy based control systems (A Pandharipande & Newsham, 2018). In commercial buildings, there are a lot of activities that are unpredictable and unscheduled. In areas that are subjected to these activities, use of local automatic techniques are more cost effective than manual control (IESNA, 2000). Occupancy sensing techniques are popular in the sector due to their easy implementation and effectiveness. Moreover, they are promoted by several building codes and green building rating systems. Occupancy sensors will be broadly presented with related devices and current studies in section 2.3.

### ***Daylight Linked Strategies***

A well-designed lighting system includes both natural and electrical illumination. The control of natural illumination is limited by its presence by the daylight and generally controlled by fixed or controllable architectural elements. Amount of natural illumination is subjected to change regarding the external factors such as time or

weather and internal factors such as spatial organization and orientation of the workstations (DiLouie, 2005).

Daylight linked control strategies are used to calibrate artificial light according to daylight level either by switching or dimming so that a specified level of illuminance is maintained (A Pandharipande & Newsham, 2018). These systems can be open loop or closed loop systems. Daylight harvesting is a kind of closed-loop control system, that detect the available daylight level in the room and regulates the artificial light according to target illuminance level (Chew *et al.* 2017). The purpose of these systems is to keep illumination level optimum and stable to give better comfort to occupants without causing glare (Lu *et al.* 2010). An open-loop control system requires a sensor on the building façade to control the lighting inside of the building with a simple algorithm. A drawback of these kind of systems is that with the use of curtain type elements, the daylight adaptation could lead to false feedback and thus discomfort inside of the room (A Pandharipande & Newsham, 2018). Table 2.5 shows the working principles of daylight sensors in an office (Chew *et al.* 2017).

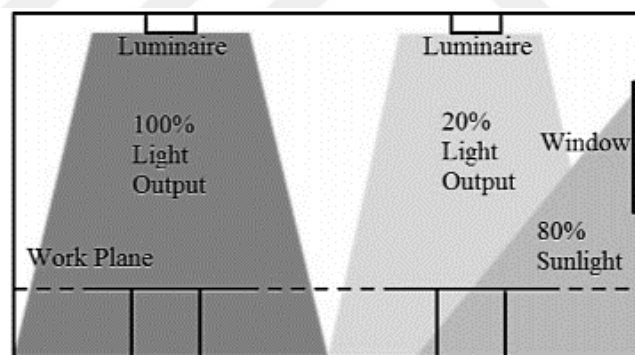

Figure 2.5. Ambient daylight is used to complement existing lighting in a room (Chew *et al.* 2017).

Previous study shows that energy savings from daylight sensors are up to 40% especially in buildings that has high amount of daylight, which shows a superiority over occupancy sensing systems (Chew *et al.* 2017).

Despite the advantages, there are several drawbacks of daylight sensors. First, the effectiveness of these systems is directly related with the latitude, orientation, window characteristics, shading devices, ceiling height and reflectance. Consequently, these systems may not be efficient for all buildings and might be disregarded after installation (Galasiu *et al.* 2004). Another study promotes this claim by presenting research results as %50 of the daylight harvesting systems are disabled by the users (Lu *et al.* 2010).

### **Scheduling**

According to a predetermined schedule of time, lighting control system operates automatically to turn on/off or dim lights. Since the system operates with time, this system is best effective in buildings where the operating hours are certain (Benya, Heschong, McGowan, Miller, & Rubinstein, 2003). With the combination of other lighting control systems such as daylight harvesting and demand control, scheduling strategies can be effective. Example of a typical weekday lighting schedule of an office building using this kind of a lighting control is presented in Figure 2.6.

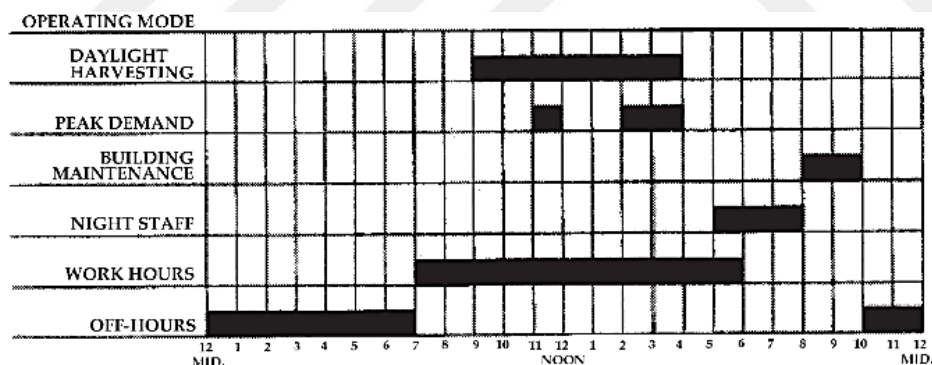

Figure 2.6. Figure showing a scheduling example from a weekday of an office building (DiLouie, 2005).

### **Task Tuning**

Based on the idea that, different functional uses require different level of illuminations, task tuning enables adjustment of local illumination level as needed. Rather than keeping the same level of illumination throughout the building, this

strategy enables savings through reducing the level of illumination where it is not needed. Task tuning can be used by controlling individual or group of luminaires and provides also flexibility for different functions (IESNA, 2000).

Task tuning can be also used for aesthetic concerns by adjusting light levels to create a specific mood. To set an example, in retail areas task lighting can be used to define spaces for display and highlight specific products (DiLouie, 2005).

### ***Demand Control***

Demand control strategy refers to reducing light levels in short periods of time where the peak electrical power demand occurs. This strategy provides energy savings and helps to avoid blackouts. Especially during the hot summer periods where the cooling load creates a peak power demand, reduction of illuminance in less critical areas can be effective (IESNA, 2000). Demand control strategies can be controlled automatically by the integrated building systems and manually by the facilities manager (Benya et al., 2003).

### ***Adaptive Compensation***

Adaptive compensation is a strategy used in night hours to reduce energy consumption and improve comfort. Required illumination levels are different between daytime to night time. In dark hours, lower illumination levels can be accepted by the users. This strategy is effective in buildings that operate 24-hours a day, where reduction of lighting levels is acceptable regarding the function of an area (Benya et al., 2003).

### **2.3.2. Selection of Lighting Control Strategies**

To achieve maximum energy efficiency, user satisfaction and compliance with the building codes; selection of the lighting control system is crucial. In the design process, lighting control strategy should be chosen to provide flexibility for flexible working hours as people might work late at night or weekends. Strategy for off-hour operations gains importance to maintain comfort for the occupants (IESNA, 2000).

According to DiLouie (2008), to determine an appropriate lighting control strategy following criteria must be considered:

- Load and space characteristics,
- Project goals,
- Energy, building and electrical codes,
- Necessity of switching or dimming,
- Required degree of automation,
- Local or central control,
- Required degree of control accuracy,
- The target value (performance/cost).

In IESNA Lighting Handbook 9th Edition (2000), it is also stated that, in the specification process, above all, beginning with the three major decisions is necessary: switching or dimming, local or central control, degree of automation.

### ***Switching or Dimming?***

Lighting load can be switched on and off by switching control. Switching systems are the cheapest way of control over lighting. Switching can be done by manually by simple wall switches, remote control devices and smart wireless systems or automatically by occupancy sensors.

Lighting load can be gradually reduced by dimming systems. Dimming systems require special hardware which makes them more expensive than switching systems. However dimming systems are more favored by occupants since they provide flexibility (Karlen & Benya, 2012).

### ***Local or Central?***

Lighting can be controlled by a local approach, central approach or both. Local control systems control divided zones in the building by wiring sensor inputs to directly to local lighting of that particular zone. Central control systems control different zones of the building all together by combining. Other building systems may be integrated with the lighting control in some central control systems (Karlen & Benya, 2012).

### ***Manual or Automatic Control?***

Selection of degree of automation, is related with the project goals, function of an area, occupancy pattern and budget. Manual control is the cheapest type of control by no extra hardware requirement. In areas automated in a regular schedule, controlled by a single building manager or in private offices by single occupant, use of manual controls are more effective than automatic controls (Karlen & Benya, 2012).

Automatic controls on the other hand, may increase energy savings since they require minimum occupant interaction. In areas where there is no certain schedule of building operation and areas that are used inconstantly, automatic control may be effective (IESNA, 2000).

By selecting the appropriate control strategy, the application of the control system can be specified by relevant devices. These devices can be chosen according to cost and its specifications.

## **2.4. Occupancy Based Lighting Control Technologies**

Main idea of occupancy-based lighting control strategies are explained briefly in Section 2.2.2. In this section related technology, factors affecting the performance and recent studies in the literature will be presented broadly.

Occupancy sensing systems, use several types of sensors to detect presence in a given area with a specified delay period (M. A. U. Haq et al., 2014). Occupancy based lighting control systems (shown schematically in Figure 2.7) basically has 4 elements: a motion sensing unit, an electrical control unit, a controllable switch (relay) and

power supply (Benya et al., 2003). The selected type of sensor receives the occupancy information and sends to control unit which is deciding to occupancy status based on its algorithm. The control unit can be manipulated to achieve necessary sensitivity (to motion) and time delay (by a programmable timing device). Output from the control unit activates the relay to open or close the circuit which energizes the luminaire (Benya et al., 2003).

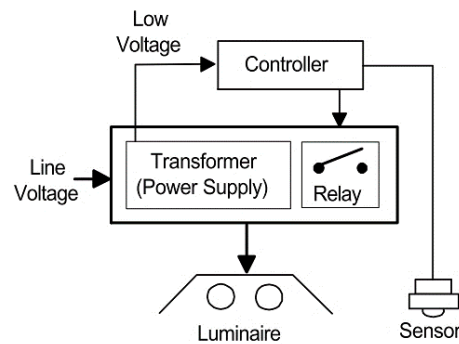

Figure 2.7. Occupancy sensor control scheme (Benya et al., 2003).

Different types of sensors use different technologies to detect motion while the control algorithm is almost the same. Figure 2.8 shows the algorithm of a typical controller schematically. If occupancy is not detected, the no-motion counter starts counting, if there is still no occupancy, occupancy state will be set not occupied. If there is motion detected, occupancy counter starts counting, no-motion counter will be reset and the space will be set occupied (Delaney, O'hare, & Ruzzelli, 2009).

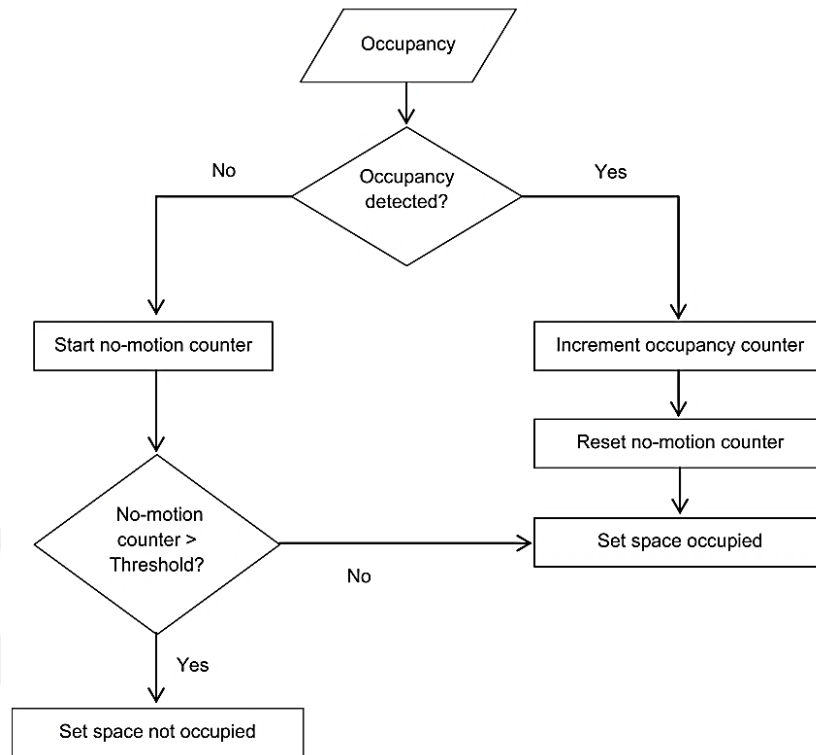

Figure 2.8. Occupancy control algorithm (Delaney et al., 2009).

Regarding the occupancy-based lighting control strategies, there are several types of occupancy sensing technologies. These technologies will be reviewed below with their working principles.

### ***PIR (Passive Infrared) Sensors***

PIR sensor detects the change in the temperature (infrared heat energy emitted by people) in its field of view (Benya et al., 2003). As it is a passive sensor, PIR sensor does not emit any energy itself. Pyroelectric detector in the device, converts infrared energy into a voltage signal by a transducer and that signal triggers the switch (Guo, Tiller, Henze, & Waters, 2010a). The pyroelectric detective is most sensitive to moving objects. Another main component is Fresnel lens which is a many faceted lens surrounding the transducer. This lens covers the area with narrow and separate beams or cones (fan shaped) which makes the sight of the sensor non continuous (Benya et

al., 2003). Figure 2.9 shows the typical field of view of a wall mounted PIR sensor. As seen in the figure there are gaps of coverage between rays and this gap increases with distance. Movements inside of these gaps may not be detected (M. A. ul Haq et al., 2014). PIR sensors are most sensitive to motion that moves one ray to another and this is why the sensors can be triggered by a handshake (Benya et al., 2003). This makes PIR sensors open to false-off errors which makes users uncomfortable. However, they are less prone to false ons then ultrasonic sensors. PIR sensors cannot detect movement at corners or areas behind partitions, they are more suitable for applications in specific portion of areas. Height of 6m or more, is more suitable for the use of PIR sensors. The sensitivity of PIR sensors depends on the quality of the product and the electric circuit design (Benya et al., 2003).

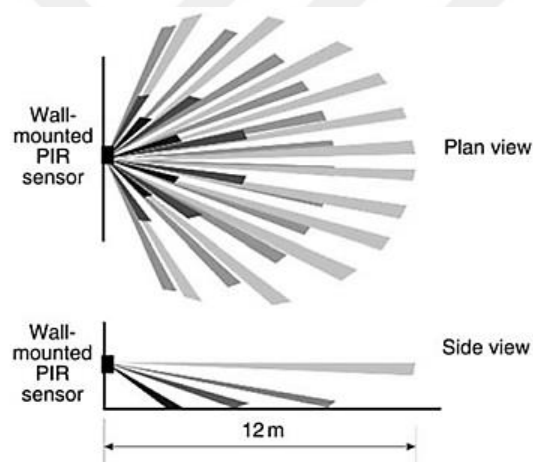

Figure 2.9. Figure showing the typical field of view of a wall mounted PIR sensor (Guo, Tiller, Henze, & Waters, 2010b).

### ***Ultrasonic Sensor***

Ultrasonic sensor sends inaudible ultrasonic waves which makes it an active device. The sensor receives back the reflected waves. Any change in the movement in the coverage area changes the frequency of ultrasonic waves (Doppler effect) and occupancy detected (DiLouie, 2005). As it is seen in Figure 2.10, the coverage area of

an ultrasonic sensor is continuous and ultrasonic waves covers the entire area by reflecting from surfaces. This way, rather than PIR sensors, ultrasonic sensors are more effective by detecting presence in corners or areas behind partitions in a room. However, for the same reason they are more prone to false triggering/ false on (by air movement, movement from adjacent areas etc.) (Benya et al., 2003). Another disadvantage of ultrasonic sensors is (also like PIR sensors), being less sensible when the movement is further although the sensitivity may change according to specific product (M. A. U. Haq et al., 2014). Use of ultrasonic sensors are more effective in 4m and less, however there are sensor that can be used up to 9m.

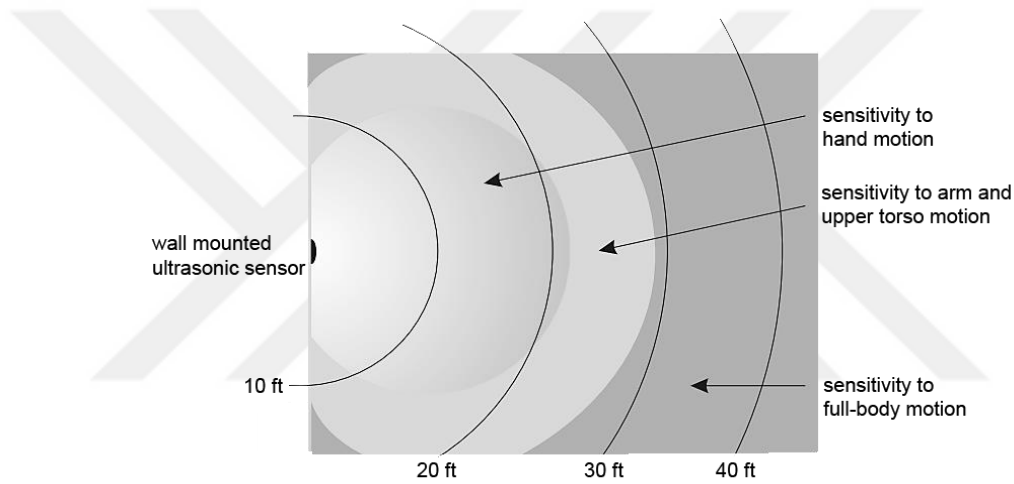

Figure 2.10. Figure showing the typical pattern of a wall mounted ultrasonic sensor (Benya et al., 2003).

### ***Microwave Sensors***

Microwave sensors work with a similar principle with ultrasonic sensors. They emit a signal (radio signal) and receive the reflected signal. If the frequency of the signal changes occupancy will be detected. According to PIR sensors and ultrasonic sensors, microwave sensors have larger coverage areas. Since they can detect occupancy in 60m distance, they are most applicable to large areas. They can detect movement

behind non-metallic materials. This makes microwave sensors vulnerable to false triggering while permitting use of this sensors out of sight. They have limited usage in buildings: school halls, sport halls, large corridors etc. (Guo, Tiller, Henze, & Waters, 2010b). Figure 2.11 shows the patterns of wall and ceiling mounting sensors.

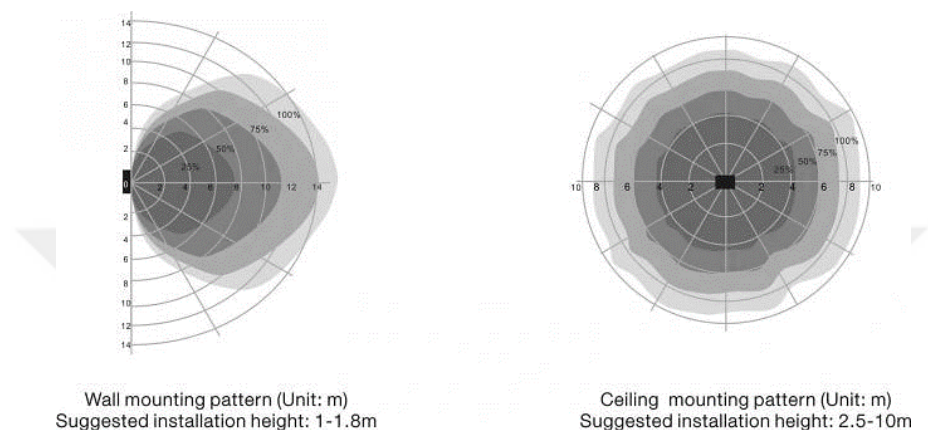

Figure 2.11. Patterns of Wall mounting and ceiling mounting patterns. Retrieved in 5 May 2019 from <http://www.light.fi/blog/microwave-sensors-utilize-lighting/>.

### ***Audible Sound Sensors***

Audible sound sensors (acoustic sensors) are passive sensors like PIR sensors as they do not emit any energy. They receive audible sound waves for occupancy detection. They are prone to false ons as any irrelevant sound from outside of the room may trigger the sensor. As a result they are not used alone but with a PIR sensor for reliability (Benya et al., 2003).

### ***Light Barriers***

Light barriers use infrared beam between two partitions and detect occupancy if the beam is interrupted. While their application for occupancy based lighting control is rare, light barriers can be used for security and presence detection reasons at the entrances or protected areas (Guo et al., 2010b).

### ***Video Cameras***

Video cameras are not used as a lighting control strategy because the related software technology is still under development. They are generally used for security purposes (Guo et al., 2010b).

### ***Biometric Sensors***

Biometric sensors are used with security purposes in restricted areas. It is not effective and efficient to use biometric sensors for lighting control due to their high costs and working principle (Guo et al., 2010b).

### ***Pressure Sensors***

Pressure sensors are also generally used for security purposes, they receive the signal by solid by vibrations (Guo et al., 2010b).

Guo et. al (2010), review the current occupancy sensing technologies in their paper and present a table (Table 2.4) to compare: PIR (Passive Infrared) sensors, ultrasonic sensor, audible sound/passive acoustic sensors, microwave sensors, light barriers, video cameras, biometric systems, pressure sensors. As it is also mentioned above, between these occupancy detection technologies, only PIR, ultrasonic, microwave and sound sensors are used for occupancy-based lighting control strategies. Other technologies may be used for specific applications.

Table 2.4. Comparison on occupancy sensing technologies (Guo et al., 2010).

| Type of sensor | Resolution | Number of occupants | Person identification | Person localisation | Initial cost |
|----------------|------------|---------------------|-----------------------|---------------------|--------------|
| PIR            | Low        | No                  | No                    | No                  | Low          |
| Ultrasonic     | Low        | No                  | No                    | No                  | Low          |
| Microwave      | Low        | No                  | No                    | No                  | Low          |
| Sound          | Low        | No                  | No                    | No                  | Low          |
| Light barriers | Low        | Yes                 | No                    | No                  | Low          |
| Video          | Very high  | Yes                 | Yes                   | Yes                 | High         |
| Biometric      | High       | Yes                 | Yes                   | No                  | High         |
| Pressure       | Low        | No                  | No                    | No                  | Medium       |

Rather than using one device, there are systems using two or more sensing technologies together. These systems are often called hybrid systems or dual technology systems. In some applications PIR and ultrasonic sensors are used together to minimize the disadvantages of both technologies, such as false-ons and false-offs (Rundquist et al., 1996).

#### **2.4.1. Factors Affecting the Performance**

In the literature, there are several studies carried on with different types of occupancy sensors. Guo et al. (2010b), presents a review on performance of occupancy based lighting control systems by the existing literature. According to their meta-analysis, they claim the energy saving performance of occupancy-based lighting control systems depends on proper installation and post-installation commissioning. Daylight availability, space function, occupancy patterns and occupant density should be examined neatly to achieve maximum efficiency before installation. Post-installation commissioning includes, change of mounting position, adjustment of angle, tuning sensitivity and replacement of flawed sensors. Haq. et al. (2014), also states that proper commissioning is crucial to achieve satisfactory performance and presents the process: Before the implementation of occupancy sensors, the function and the occupancy pattern of the room/area should be examined to decide whether this room/space is suitable for occupancy based control. The more infrequent or irregular the occupancy is the more savings can be achieved by using occupancy sensors without discomfort on the occupants. If the room/area is suitable for occupancy detection then analysis of the occupancy pattern, size of the room and activity areas must be done for effective commissioning. Based on these analyses, the tuning of time delay, sensitivity, positioning and coverage angle must be done. The effects of these factors are given in the same research by a table (Table 2.5).

Table 2.5 Effects of time delay, sensitivity and coverage area on occupancy sensor performance (M. A. ul Haq et al., 2014).

| Parameter     | Too high   | Too low   |
|---------------|--|---|
| Time delay    | Less savings   | Reduced lamp life due to frequent switching, Possible user dissatisfaction  |
| Sensitivity   | 'False On' – detecting false movements coming from sources other than occupants, thus keeping lights on            | 'False Off' – failure to detect occupants, thus turning lights off despite presence, resulting in user dissatisfaction as well as unnecessary switching |
| Coverage area | Too large<br>Detection of movement from adjacent space through doors/windows, thus keeping lights on unnecessarily | Too small<br>Results in undetected zones in the workspace, where occupants are not detected despite presence  |

Time delay setting stands for the pre-arranged period that the system waits after the unoccupied condition is detected. Time delay setting must be done according to analysis of occupant pattern in the room/area. In an experimental research on effects of time delay settings in different type of rooms shown in Figure 2.12. Researchers have found out that the lower the time delay setting, the higher the energy saving potential for all types of rooms (Richman, Dittmer, & Keller, 1996). However, regarding the different functions, occupancy and occupant type of chosen rooms, the increase in potential of savings changes. While staff rooms (higher occupancy) has the highest increase in energy savings by lowering the time delay settings, the restroom (lower occupancy) has the lowest increase.

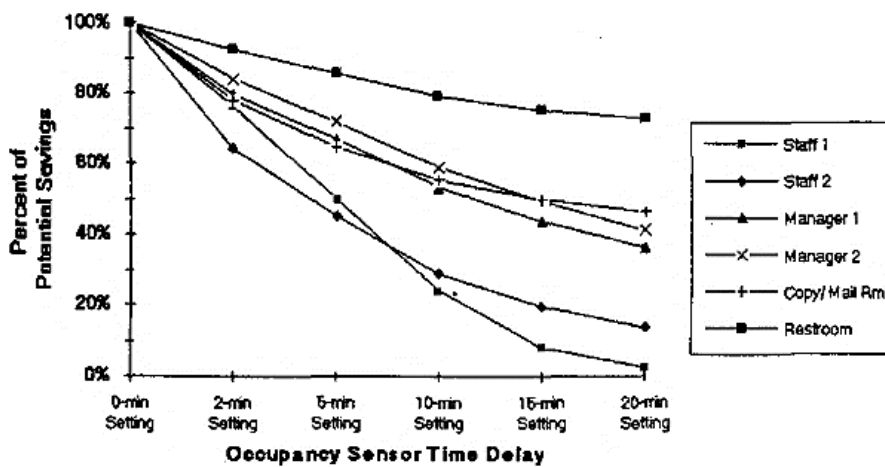

Figure 2.12. Figure showing the potential savings from different rooms by different time delay settings (Richman et al., 1996).

There are other studies, claiming that fixed time delay arrangement wouldn't be effective since occupant and time of the day may require differences. Garg and Bansal (2000), proposes a smart occupancy sensor, that changes the time delay setting according to time regarding different activity levels. By this method, energy savings are increased 5% in comparison with fixed time delay settings.

When an occupancy sensor operates alone to switch lights on and off, it may cause energy waste by switching lights on according to presence of occupants while daylight level is already enough for visual comfort. In this regard an additional control strategy can be used to increase the performance, such as time scheduling or daylight harvesting. Because even if there are additional manual switching systems, research shows that users are less likely to switch off the light even if they are unnecessary (Nagy *et al.* 2015). Haq et. al. (2014), presents a meta-analysis on savings achieved in different research using different hybrid systems in Table 2.6.

Table 2.6 Savings from hybrid occupancy-based systems in the literature (Haq et. al., 2014).

| Room type | Combination                     | Savings (%) | Reference              |
|-----------|---------------------------------|-------------|------------------------|
| Office    | Occupancy++daylight             | 46          | Jennings et al. [34]   |
| Office    | Occupancy++daylight             | 68          | Hughes et al. [36]     |
| Office    | Occupancy++daylight             | 49–63       | Roisin et al. [20]     |
| Office    | Scheduling++daylight            | 38–61       | Rubinstein et al. [71] |
| Classroom | Scheduling++occupancy++daylight | 35–42       | Martirano [72]         |

#### 2.4.2. Recent Studies on Occupancy Based Lighting Control

In this section, recent studies on occupancy-based lighting control systems will be presented with the critical analysis. While majority of the research is on energy saving performance, there are few experimental studies considering the user satisfaction in different aspects.

There are several state-of-art reviews on occupancy-based lighting control which are presented here in a chronological order. Guo *et al.* (2010b) presented a review on the performance of occupancy based lighting control technologies and concluded that more effective control can be achieved by using a network of occupancy sensors with better sensing and more extensive analysis of sensor data. Williams *et al.* (2012) made a meta-analysis on lighting energy savings defined in the literature on different lighting control strategies. Based on their work, the average potential savings from occupancy sensors is 24%, from day lighting is 28%, from personal tuning is 31%, from institutional tuning is 36% and from control with multiple strategies is 38%. Haq *et al.* (2014) presented a review on lighting control technologies used in commercial buildings by their performances and affecting factors. Pandharipande and Caicedo (2015) reviewed smart luminaire based sensing systems for lighting control in office buildings with two system approaches: centralized and distributed control. While the literature reviewed in their article is on system architecture, as it is also valid for papers above, the conclusion is driven in a quantitative manner. Bakker *et al.* (2017) reviewed the state-of-art on occupancy based lighting control in open plan offices. Authors

addressed to lack of research in the literature on user satisfaction and comfort. They also revealed that different occupant and space types should be studied by case studies to better identify the effects of occupancy patterns. The lack of recommendations in guidelines and standards on user-centered lighting control approach is also revealed by this review. While these reviews present that the previous literature on occupancy based lighting control strategies are on energy savings and there is lack of research on occupant comfort, Galasiu and Veitch (2006), present an overview on studies of user satisfaction and acceptance on electric lighting. However, these studies were generally on daylight availability, user-controlled lighting and use of photo sensors. Authors present few studies on acceptance on occupancy sensors, but the findings did not go beyond indicating favor or discomfort.

Wen and Agogino (2008), described a wireless network lighting system that both improves energy efficiency and user satisfaction in open plan offices. Proposed system optimizes the lighting settings by individual preferences feedback and occupancy status. However, the experiment carried on with this system, revealed only the desk illumination levels to show whether the system works or not.

Byun, Hong, Lee and Park (2013), proposed an intelligent household LED system considering energy efficiency and user satisfaction. The proposed system uses multiple sensors (light sensors and occupancy sensors) and wireless communication technology to control illumination intensity by user movement and brightness in the area. Figure 2.13 shows the basic principle of the system. When the occupancy is detected the light intensity increases to  $L_{max}$  (pre-defined value), then no movement is detected after the pre-defined delay time, the light intensity decreases to  $L_{min}$  (predefined). Authors suggested that the defining the pre-set values ( $L_{min}$ ,  $L_{max}$ ,  $T$ ,  $T_r$ ,  $T_m$ ,  $T_f$ ) shown in the Figure 2.13, is essential to achieve maximum satisfaction and efficiency. These values should be defined according to characteristics of the space. Authors tested the system in a test bed and achieved up to 21% reduction in energy use. However, they did not reveal any feedback from the users.

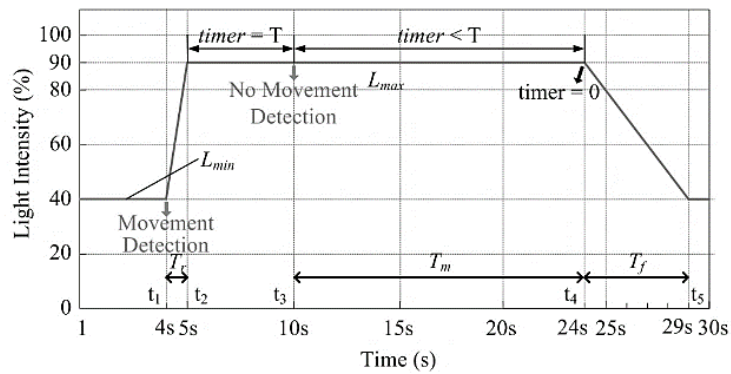

Figure 2.13. Basic operating principle of the system (Byun *et al.*, 2013).

Byun and Shin (2018) stated that, the most significant problem on current energy saving lighting systems is not considering occupant satisfaction which results in lack of acceptance in complex spaces. They proposed an energy efficient lighting system considering the user satisfaction. The system uses motion and light sensors to collect surrounding information similar to the research of Byun *et al.* (2013). In addition to previous work, in this paper, different space characteristics are involved to the study. Spaces are classified as wide type spaces, small type spaces and corridor type spaces. The proposed system is implemented in a test bed with 6 lighting control parameters which are same as the parameter shown in Figure 2.13. In corridor type spaces, authors address the problem of current technology which makes occupants to walk in dark corridors before activation of the sensors. To solve this problem, the proposed system dims the light down without turning them off completely. Figure 2.14 shows the model for the operation. Results of the study show that, significant energy savings are achieved. The survey done with the building occupants (n: 259), revealed that 79% of the participants did not feel uncomfortable while 28% of them did not even notice the difference. This research makes a major contribution to the lack of literature on user satisfaction on occupancy-based lighting control systems and proposes a lighting control system to solve these problems. However, it is still not giving insight on perspective of occupants to reveal criteria behind satisfaction.

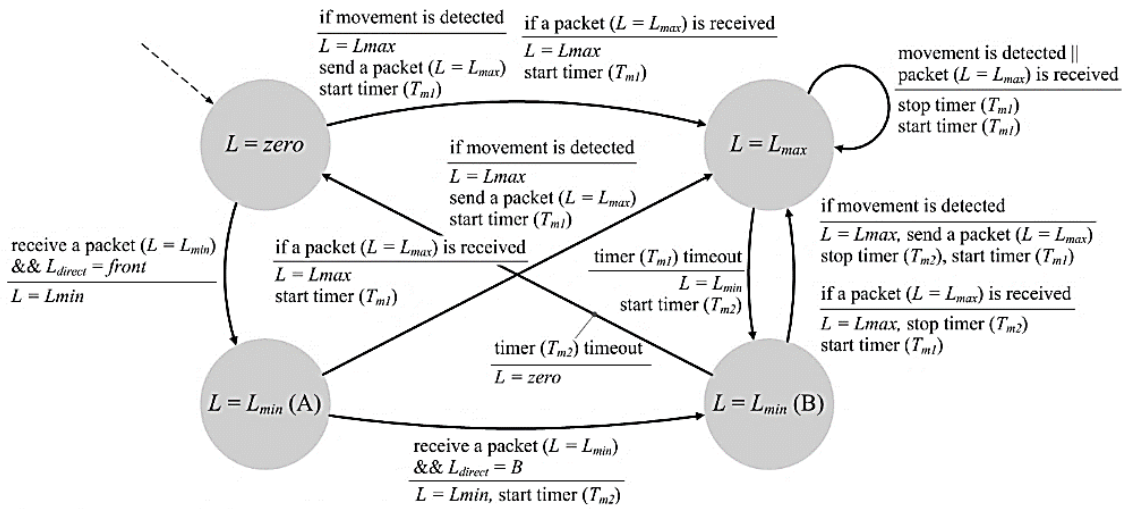

Figure 2.14. Model for the light control in corridor type spaces (Byun & Shin, 2018).

Chraibi, Creemers, Rosenkötter, van Loenen, Aries and Rosemann (2018), did a research on user oriented sensor based lighting control systems for open plan offices. They tested different dimming speeds with 17 participants in a test bed. Participants evaluated the different dimming scenarios by measures of noticeability and acceptability. The results show that noticeability increases when the fading time is shorter thus, it is found to be acceptable by 70% of the participants that at least 2 seconds of fading time is acceptable.

Bakker, Aarts, Kort and Rosemann (de Bakker, Aarts, Kort, & Rosemann, 2018), did an experimental study to increase occupant comfort by highly granular lighting control in open plan offices. They suggested that typical switching on/off approach by sensor control, results in discomfort by non-uniform illuminance distribution. They addressed to lack of research on user acceptance on sensor-based lighting control. To overcome that problem, they proposed and tested a new concept that composed of different illumination levels by dimming on task, surrounding and background areas. 25 participants evaluated 9 different lighting scenarios (Figure 2.15) in a controlled environment. The user evaluation measures were appraisal, comfort, acceptance and satisfaction. As a result, the condition with similar task and surrounding illumination

levels which are greater than the background illumination level accepted by most of the occupants. While this research gives insight about background illumination and user satisfaction, it is limited by the open plan office environment.

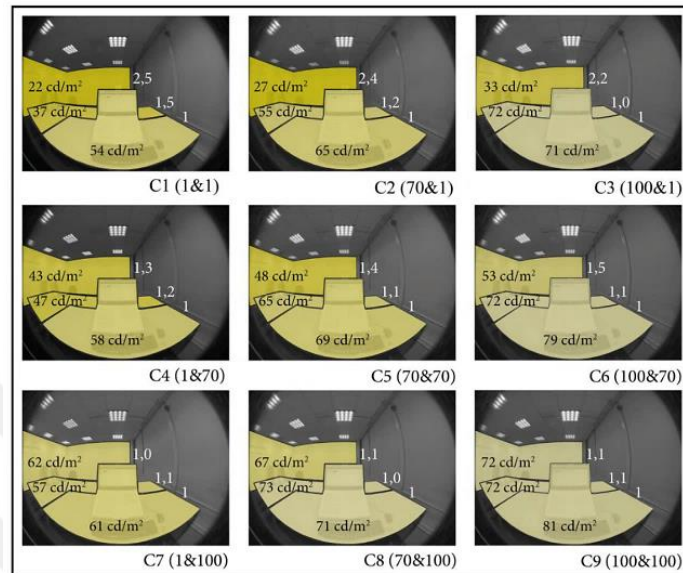

Figure 2.15. Figure showing the 9 lighting scenarios tested in a controlled environment (de Bakker et al., 2018).

Tan, Caicedo, Pandharipande and Zuniga (2018), proposed a lighting control system to improve user satisfaction in office environments. They combined user feedback data to occupancy and light data to achieve improvement in user satisfaction by optimum dimming levels. Results of the study presents that, with the implementation of this system, preferred lighting conditions by users are achieved. However, this study does not give any results on the user evaluation and its criteria.

Park, Dougherty, Fritz, and Nagy (2019), also pointed out that lighting control systems are now very sufficient in terms of energy efficiency while they are ineffective providing comfort to the occupants. Researchers developed an occupant centered controller for lighting which is based on reinforcement learning which adapts itself to environmental conditions and occupants. They carried on an experiment with the proposed product for 8 weeks in 5 offices and revealed that by the use of this system

lighting conditions are improved. They suggest that by the use of such technology for lighting control, balance between energy efficiency and user satisfaction can be set.

To overcome the user discomfort with occupancy sensors, different time delay setting solutions are proposed and tested by several researchers. Garg and Bansal (2000), offered a smart adapting occupancy sensor that reacts activity changes during the day and adapts the delay time accordingly. They claim to have improved energy efficiency by 5%. Leephakpreeda (2005) also proposed a similar adaptive strategy to overcome the time delay trade-off (higher time delay results in less energy savings, lower time delay results in occupant discomfort) by Grey prediction model. Developed model determines the time delay setting by the trend of the occupant's activity. Author claims, achieving optimum time delay setting is possible by this method. Inspired by the previous work of Garg and Bansal (2000) another system is developed and tested by Nagy *et al.* (2015). In their proposed system, again an adaptive time delay setting is proposed with a light sensor integration. Light sensor indicates if the room is dark or light and sends signal to control unit. Table 2.7 summarizes the main actions of the control system. Results of the study shows that up to 37.9% energy savings can be obtained. The user satisfaction is evaluated only by the lack of complaints.

Table 2.7. Control table showing the summary of the main actions of the control system (Nagy et al., 2015).

| Room state |       |      |        | Control action |
|------------|-------|------|--------|----------------|
| Occupied   | Light | Dark | Bright |                |
| 0          | 0     |      |        | -              |
| 0          | 1     |      |        | Turn off       |
| 1          | 0     | 1    | 0      | Turn on        |
| 1          | 0     | 0    | 0      | -              |
| 1          | 0     | 0    | 1      | -              |
| 1          | 1     | 1    | 0      | -              |
| 1          | 1     | 0    | 0      | -              |
| 1          | 1     | 0    | 1      | Turn off       |

There are several studies on the validity of the simulation tools on the performance results. Bellia et. al (2015) analyzed the effectiveness of currently available simulation tools (Daysim, DIVA, SPOT) in terms of specifying the energy saving

performance of lighting control systems. According to their analysis, these simulation tools are not able to take all the factors affecting the performance into account. For example, occupancy patterns are prone to change but these tools only simulate the given data by building schedule. Moreover, it is not possible to choose different sensor typologies. Authors suggest that, these affecting factors should be added to the simulation results to achieve better judgment on performance of each type of control systems.

To sum up, in this chapter, literature knowledge on the lighting quality elements, lighting design process, lighting control strategies and technologies is presented. In detail, occupancy-based lighting control technologies are explained and recent studies on occupancy based lighting control are highlighted. There are many studies on energy saving potentials of occupancy sensors. It is also pointed out in the literature that, there is lack of research on user satisfaction of these systems. While there are certain attempts to improve sensor-based lighting control technologies, these studies remained insufficient in presenting an evaluation in terms of user perspective. These researches made a valuable contribution to the literature by focusing on problematic situations, but there is still a gap in the literature. In the “conventional use of occupancy sensors”, user steps in a dark area, only after a sensor detects occupancy and that area becomes lit. Especially in night use this is problematic for the occupants. To overcome this, in the literature constant minimum level of illumination is proposed and tested. Even though, results show energy saving potentials, evaluation on the user satisfaction was not sufficient. Improved products with user-oriented time delay settings to overcome false ons are also tested; but these results also deficient on presenting a user evaluation. In terms of circulation areas, there is no particular research on the issue and this remains as a gap in the literature. Moreover, there is no research on the lighting control for off operation hours (night hours). This is also an important case to be studied to provide user comfort while maintaining energy efficiency.



## CHAPTER 3

### MATERIAL AND METHOD

In this chapter, material and method of this research are presented. First research problem is explained, and related research questions are stated. Then research design is explained. Related information about the participants are given. Existing situation of the experiment area is shown, experimental setting is depicted, and experimental scenarios are highlighted by the related instruments. The procedure is explained, and evaluation measures of the study are addressed. Finally, relevant statistical analysis methods are presented.

#### 3.1. Research Problem and Research Questions

While the use of occupancy sensors are efficient in terms of energy efficiency, it may not be efficient in terms of user satisfaction in circulation areas. Use of occupancy sensors are accepted by the users in areas like WCs and building stairwells/halls, but they are not fully accepted in circulation areas of large buildings and may end up being neglected or rejected. Especially in the night use, dissatisfaction would be even higher by the occupants in circulation areas. As also pointed out in the literature, conventional use of occupancy sensors may cause dissatisfaction in the circulation areas. This is a challenge in acceptance of energy efficient lighting control technologies.

Regardless of possible technical problems (false triggering, false offs, false commissioning *etc.*), this dissatisfaction may be originated from the conventional use of occupancy sensors itself (occupant steps into an area, the sensor in the area activates and energizes the luminaires in that area). So, occupants mostly step into a dark area during the night use.

As it is pointed out in previous chapters, in the literature there are very few studies based on evaluation of sensor-based lighting control strategies in terms of user satisfaction. These studies have focused on evaluating the effects of different delay times or lighting levels on user satisfaction and energy efficiency. However, there is no particular research on different combinations and different triggering scenarios of sensors and zone of luminaires in terms of user satisfaction and energy efficiency in circulation areas in night use.

METU Faculty of Architecture (FA) main building in this regard believed to be a good case to conduct an experimental study on the issue. It has been observed that there is an energy efficiency problem in the current lighting control system of the circulation areas of METU FA. In the current use, lighting is controlled by simple on/off wall mounted switches controlling zone of luminaries and thus circulation areas are lit for 24 hours occupied or not. As it is a building open to 24 hours of occupation a day, there is a huge difference in the occupancy patterns between daytime and nighttime. In the light of information deduced from Chapter 2, among the existing lighting control strategies, personal tuning is not suitable for common used areas in buildings in terms of energy efficiency. Institutional tuning strategies also mentioned above, are only efficient when the schedule of the building use is uniform and steady. Day lighting strategies can be integrated with the occupancy strategies to achieve better energy savings and user satisfaction. In this study, the focus will be on occupancy-based strategies alone since the research problem is particularly on the circulation areas of a university building that is used also in night hours.

Research Questions:

1. What would be the difference in user evaluation between different combinations of occupancy sensors and zone of luminaires?
2. In the evaluation of the scenarios, what would be the factors causing satisfaction or dissatisfaction?

3. What would be the comparison on energy saving potentials of these experimental lighting control scenarios?

### **3.2. Study Design**

In the experiment there were 4 different lighting control scenarios. Since there was no previous research could be a base for these scenarios, the 4 different lighting scenarios and evaluation criteria are created based on literature knowledge, observations and discussions with the peers. A “within subjects repeated measures design” method was applied in the experiment. Same participant experienced each of the 4 scenarios and made an evaluation. 38 participants participated to the study on 6-7 April 2019. Since the focus was on night use, experiments were conducted in dark hours. To create a baseline for the sensor-based scenarios, first scenario (Scenario A) was the current lighting control situation where all lights were on. The other 3 scenarios (Scenario B, C, D) were occupancy-based sensor control scenarios. In terms of within subjects repeated measures design procedures, the order of the scenarios was randomized for scenario B, C and D for each participant to enhance credibility.

### **3.3. Participants**

Familiarity with the experiment area was an important criterion in this research. Participants had to be the users of the selected building because sense of strangeness could affect the evaluation of the experimental conditions. Occupants in the building at the time of the experiment who have normal or normal corrected vision were invited to join to the experiment. Occupants were informed by the researcher and voluntarily participated to the experiment by signing a consent form which informed them about the purpose and the procedure of the study. In total 38 people (16 females, 22 males, with an age range of 18-29 and a familiarity range of 1 years to 10 years) participated in the study and the results of 37 participants are used in the analysis since one of the

participants did not evaluate one of the scenarios. In Appendix A, ages, genders and familiarity data of the participants are given. Familiarity with the building was important since it may affect the evaluation of the lighting conditions. The participants were familiar with this building being occupants for 5 or more years (19%), 4 years (19%), 3 years (19%), 2 years (19 %) and 1 year (%24).

### **3.4. Experiment Area**

METU FA building was designed by Behruz and Altuğ Çinici in 1961. Architecturally it is a significant building being a notable representative example of its period and started to be considered as a modern heritage in terms of architectural values. Therefore, one of our primary concerns was not to harm the building.

At this section, architectural information and existing situation of the experiment area will be outlaid. East entrance on the upper ground floor of the METU FA building with the surrounding circulation areas depicted in the Figure 3.1, is chosen as the test bed area. This area is the only entrance available at off operation hours (weekends and night hours) and found to be problematic in the night use in terms of user satisfaction by the building occupants. Since there were few openings in the area, control on the lighting conditions was also convenient for an experiment.

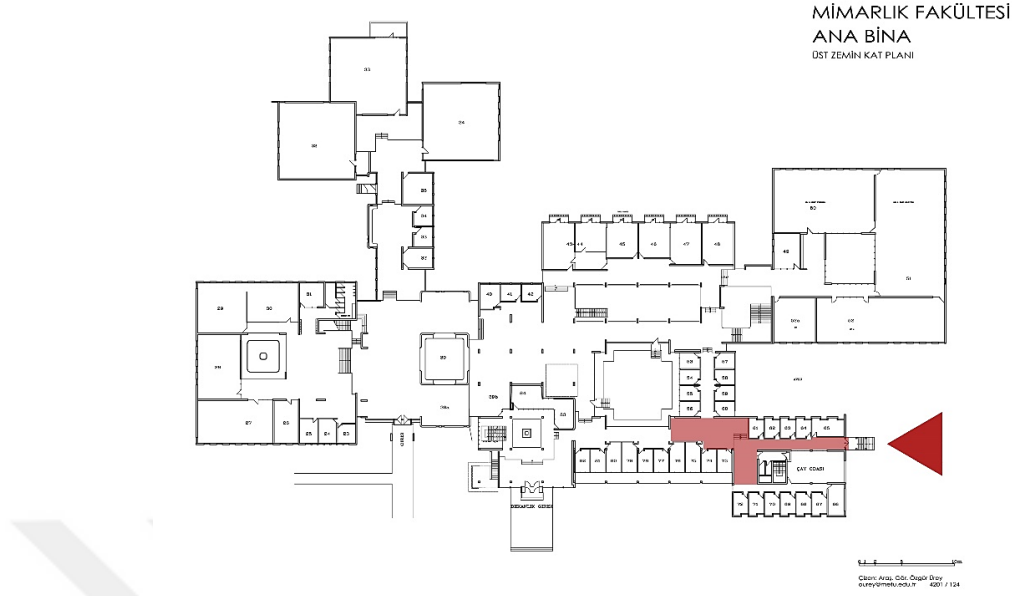

Figure 3.1. Upper Ground Floor Plan of the METU FA (plan drawn by Özgür Ürey).

In Figure 3.2, existing situation of the experiment area is shown by viewpoints on the plan and related photos. There were two stairs in the testbed, one at the entrance and one at the end of the corridor. In the entrance there is an apron. At the off-operation hours, the exterior door is unlocked but the interior door is locked and can be unlocked by ID cards of faculty students. There was a common room (Çay Ocağı) for the staff in the faculty which is juxtaposed to the testbed area. The plan of the common room can be seen in Figure 3.2. This room was used as a control room in the experiment which was completely unseen to the participants.

The lighting control was manual by simple on/off wall switches. Wall switches (shown in blue in Figure 3.3) controls sets of lamps in the zones. In the day time, half of the lamps are on and in the night time all lamps are on (Since there is no institutional control and wall switches are open to access by everyone, the lighting control situation may change day by day). In Figure 3.2 (a), daytime situation can be seen.



Figure 3.2. Experiment area in daytime (Viewpoints are given on the plan).

In the existing lighting situation, in total there are 13 lighting fixtures in the area shown in Figure 3.2. Lighting fixtures are round shaped compact fluorescent lamps (CFL) as it can be seen in Figure 3.3.



Figure 3.3. One of the existing CFLs in the experiment area.

### **3.5. Experimental Setting**

In this section, setting of the experiment area, experimental lighting control scenarios, material selection for the experiment and control method of the experimental lighting control scenarios will be outlaid.

#### **3.5.1. Setting**

The experiment area is divided into 3 zones. This zoning was decided by the researcher to test the research questions effectively. Figure 3.4 is showing these zones, there are respectively 6,2 and 5 luminaires in Zone 1, 2 and 3. Position of the luminaires and sensors are also given in Figure 3.4. Location of the existing luminaires are used in the experiment to create resemblance to the existing situation.

During the experiment, 3 experiment conducting controllers were present at the experiment area. Positions of the controllers can be seen in Figure 3.4. Controller 1 was controlling the scenarios in the control room (Figure 3.4a). Controller 2 was at the start point to give information about the experiment and collect the necessary information from the participants. Controller 3 was at the end of the experiment area, to give evaluation forms at the end of each scenario. Controller 2 and 3 were also responsible for controlling the traffic on the experiment area by not permitting passage during the experiments. For communication between the controllers, walki-talkies were used.

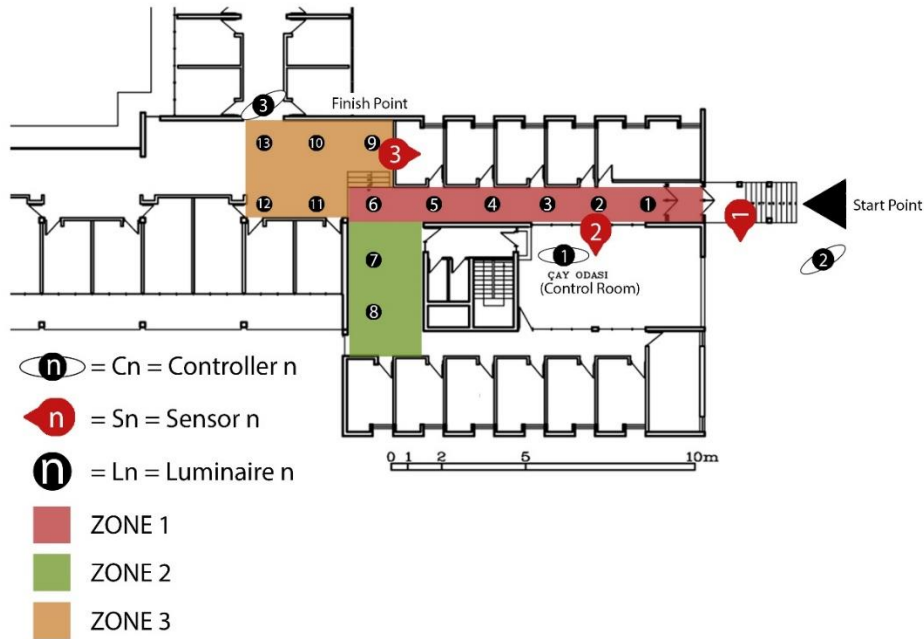

Figure 3.4. Plan denoting the location of zones, luminaires, sensors and controllers.

### 3.5.2. Experimental Scenarios

Table 3.1 shows brief explanations of these scenarios and Table 3.2 schematically shows the positions of the occupants, sensors, and lighting conditions in terms of triggering moments. The terms ‘Inside triggering’ and ‘Outside triggering’ are given by the researcher to easily distinguish the different scenarios by name. ‘Inside triggering’ stands for switching a set of luminaires on by triggering an occupancy sensor in the same zone. ‘Outside triggering’ stands for switching a set of luminaires on by triggering an occupancy sensor which is outside of the same zone (neighboring zone). For the exploratory nature of this study, lighting control scenarios designed one way as the participants had to experience each scenario from the beginning of the experience area to the end and not vice versa. For all sensor based lighting control scenarios, it was assumed that there is a backup lighting system which is controlled manually by existing wall switches, however it was out of scope in this study.

Table 3.1. Brief explanation of the lighting control scenarios.

| Scenario   | Sensor use                             | Brief explanation  |
|------------|--|--|
| Scenario A | No sensor                              | All luminaires are on (Existing lighting control system).  |
| Scenario B | Inside triggering                      | Zone of luminaires turn on when an occupancy sensor in the same zone is triggered.   |
| Scenario C | Outside triggering                     | Zone of luminaires turn on when an occupancy sensor outside of the same zone is triggered.   |
| Scenario D | Outside triggering + Inside triggering | Zone of luminaires turn dimly lit when an occupancy sensor outside of the same zone is triggered and fully lit when an occupancy sensor in the same zone is triggered. |

Table 3.2. Lighting control principles shown schematically for each scenario.

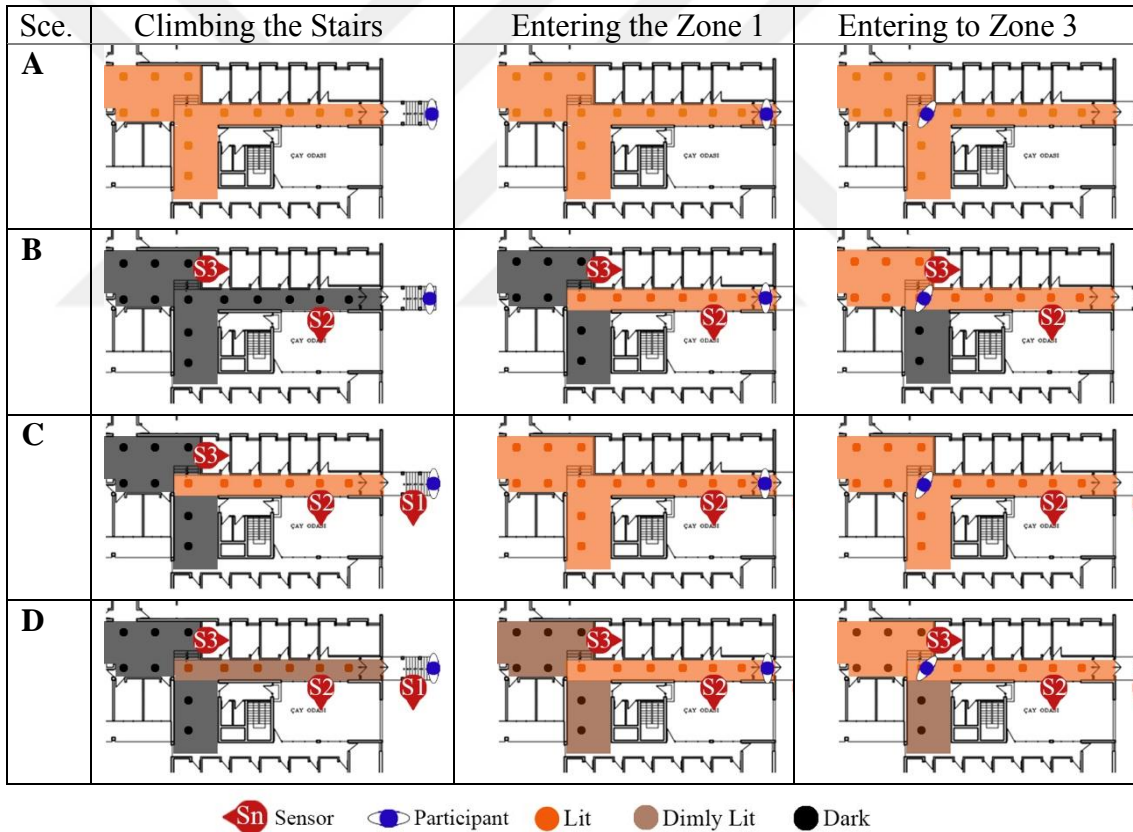

In existing situation (Scenario A), all luminaires were always on, participants saw a lit area before entering the building and stepped inside of a lit area, while areas in their sight of view were also lit.

In Scenario B (conventional use of occupancy sensors), participants confronted to a dark area while going up the entrance stairs. They stepped inside of the dark corridor only after, S2 is triggered and zone 1 was lit. While they were proceeding through the corridor (zone 1), there were dark areas in their sight of view (zone 2 and zone 3 were dark). When participants turned into zone 3, S3 was triggered and luminaires in zone 3 was lit.

In Scenario C, when participants started climbing the stairs outside, S1 triggered and zone 1 was lit. As participants proceeded to the entrance door, they confronted a lit area behind the entrance door and thus stepped into an already lit area. As they stepped in S2 triggered to lit zone 2 and zone 3. So, when participants entered the building, areas in their sight of view became lit. As they proceeded to zone 3, they face lit areas in their sight of view and when they turned into zone 3, zone 3 was already lit.

In Scenario D, when participants started to climb up stairs outside, S1 triggered and lit zone 1 in the minimum light level. As they entered the building, they stepped into a semi lit area and when S2 triggered, zone 1 turned into fully lit while adjacent zones (zone 2 and zone 3) lit into minimum light levels. As they walked through the corridor, they had semi lit areas in their sight of view and when they turned into zone 3, they stepped into a semi lit area then immediately S3 triggered and zone 3 became fully lit.

For all sensor based scenarios (Scenario B, C and D), commissioning setting of the sensors were constant to compare these scenarios in terms of different triggering configurations. Positioning angle of the sensors, time delay settings (5 minutes) and fading time was the same. Time delay setting was set in a maximum values, since the focus of this study was not on the evaluation of the time delay values. In terms of walking speeds and length of the experiment area, 2 minutes time delay was enough for participants to walk and evaluate each of the scenarios. In the real application, these setting would be much more lower to have better energy efficiency. Calculations of energy saving potential will be made on proposed time delay settings for the circulation areas.

It should also be noted that, this experimental setting was set one way and experiments were done for one participant at a time. So, possible encountering of the occupants coming from both sides, is neglected since this scenario would bring a lot more variables to the experiment.

### **3.5.3. Material Selection and Application**

In the realization of the experimental scenarios, material selection and application were done to achieve easy control on the scenarios. An automated control system (DALI) was considered for the setup of the experiment first, for the proposed user centric sensor control systems, it was indicated by the counselors that these systems cannot be realized through existing software. So, setting was done with a simpler system (with simple occupancy sensors, cables, LED bulbs and plugs) and by simple electrical equipment. Existing light bulbs are not used and were turned off during the experiments. It was not possible to do any sort of construction in the building, so the experiment area was set with the help of cables and tapes attached to existing luminaires and walls (See Figure 3.5b). Cables coming from all 3 zones were collected in the control point which can be seen in Figure 3.5b and Figure 3.5c. In each zone there were 2 lines; one of them was carrying high light intensity bulbs and the other carrying low light intensity bulbs. From now on each line will be named by its zone number and level of light intensity. For examples, 'H1' denotes the line of high light intensity light bulbs in Zone 1, 'L2' denotes the line of low light intensity bulbs in Zone 2. Each luminaire in a line is powered on simultaneously by parallel electrical connection.



Figure 3.5. Inside of the control room (a), cables going into control room (b), control point in the control room (c).

For experimental purposes and to realize Scenario D, low light intensity light bulbs are hanged juxtaposed to high light intensity light bulbs to give the feeling of transition from dimmed light to full light. Figure 3.6 shows the set up for one luminaire, light bulbs and cables used for setting them onto existing light bulbs for the experiment. The selection of the light bulbs in terms of their light intensity levels was done by choosing the lowest and highest light intensity bulbs in the market to create a clear experience for Scenario D (Selection of light intensity levels was not a focus in this study). High intensity bulbs were borrowed from the technical storage of METU FA.

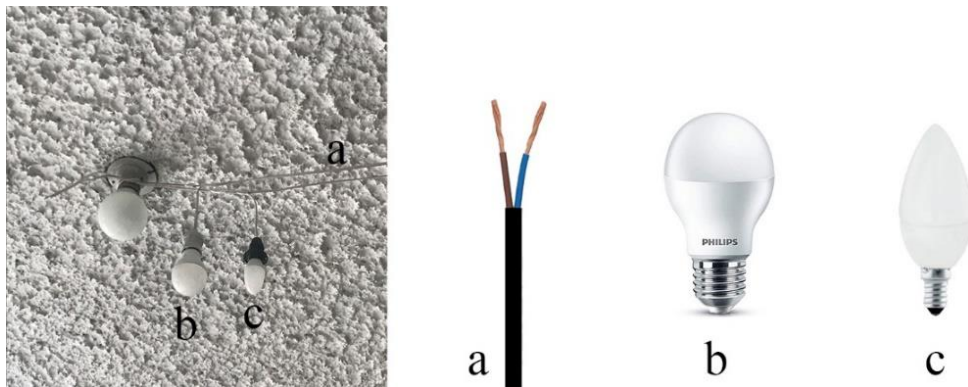

Figure 3.6. Setting of the luminaires.

In total; 2 for each of the 3 zones, there were 6 lines of luminaires. At the end of each line of luminaries there were male plugs. Figure 3.7 is showing these male plugs with the code of lines. This coding was important for controlling the experimental scenarios.



Figure 3.7. Plugs of the 6 lines of luminaires.

There were 3 microwave sensors used in the experiment. As it can be seen in Figure 3.8 each sensor has one input and one output with two terminals of each. Input side is directly connected to the grid voltage line and neutral terminals by a male plug (Figure 3.8). Two output terminals float when sensor does not trigger. When sensor triggers, output terminals of sensor power on. Sensor internally connects grid line and grid neutral terminals to the two output terminals. Two output terminals of sensor were directly connected to corresponding female plug as shown in Figure 3.9. By this way, when sensor is triggered, a female plug is powered on. Desired scenarios are constructed by connecting line of luminaires' male plugs to the corresponding sensor's female plugs. Triple sockets are used to multiplex output of one sensor to switch on more than one line of luminaries.

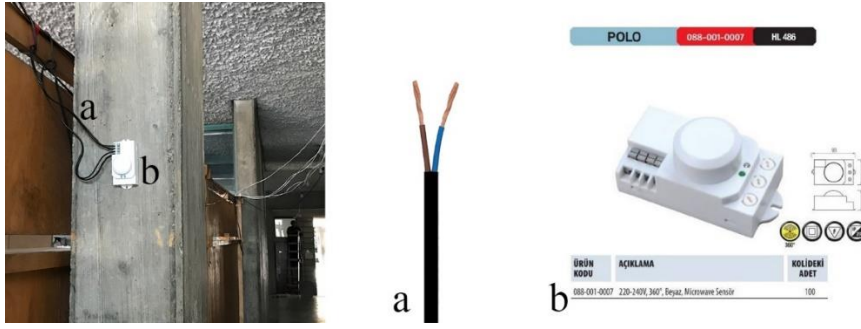

Figure 3.8. Setting of the microwave sensor.



Figure 3.9. Plugs of the sensors (3 female plugs for connection to the line of luminaires, 3 male plugs for connection to the grid).

Materials selected for this experiment and used for the application are shown by their images, properties and quantities in Table 3.3.

Table 3.3. Materials used for the experiment.

| Material  | Image   | Properties                            | Quantity  |
|---|---|---------------------------------------|-----------|
| Eglo E14 LED Bulb                               |    | 3 Watts<br>250 Lumens<br>Warm White   | 13 pieces |
| Philips E27 LED Bulb                            |    | 14 Watts<br>1521 Lumens<br>Warm White | 13 pieces |
| Horoz Microwave Sensor                          |    | 220-240 V<br>360°                     | 3 pieces  |
| E27 Light Socket                                |    | Type F                                | 13 pieces |
| E14 Light Socket                                |    | Type F                                | 13 pieces |
| AC Male Plug                                    |   | Type F                                | 9 pieces  |
| AC Female Plug                                  |  | Type F                                | 3 pieces  |
| Three-way Multi Plug Socket with extension cord |  | Type F<br>with switch                 | 1 piece   |
| Three-way Multi Plug Socket                     |  | Type F<br>without switch              | 1 piece   |
| Cable   |  | 2x0,75                                | 200m      |
| Walki-Talkie                                    |  | 3km range                             | 2 pieces  |
| Light Meter PCE – 170 A                         |  | Measurement range from 0 to 40000 lux | 1 piece   |

### 3.5.4. Controlling the experimental scenarios

Previously in section 3.1., experimental scenarios are explained. In this section realization of the experimental lighting control scenarios will be outlined. Figure 3.10 shows schematically the connections by the sensors and line of luminaires.

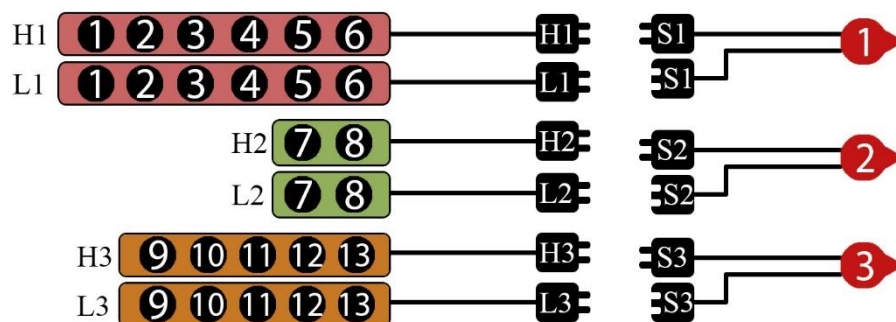

Figure 3.10. All connections by the sensors and line of luminaires (Male and female plugs are depicted schematically).

Each scenario was set up using these connections. For example, to activate S1, male plug S1 will be connected to the grid. To control H1 (High intensity luminaires in Zone 1) with S1, male plug H1 will be connected with female plug S1. Then when S1 is triggered, H1 will power on. Below connections are explained for each scenario.

#### *Scenario A – All lights are on (Existing situation)*

There is no sensor in this scenario. As it is the existing lighting control scenario, all lights are on, regardless of the occupancy in the area.

Plug H1, H2 and H3 to the grid by the help of a three-way multi plug socket.

#### *Scenario B – Inside triggering*

Conventional way of using occupancy sensors. Line of luminaires in the zone in controlled by a sensor in the same zone.

S2 and S3 are plugged to grid by the help of a three-way multi plug socket.

H1 is plugged to S2 female plug. H3 is plugged to S3 female plug.

#### *Scenario C – Outside triggering*

Line of luminaires in the zone is controlled by a sensor positioned in the previous zone.

S1 and S2 are plugged to grid by the help of a three-way multi plug socket.

H1 is plugged to S1 female plug. H2 and H3 are plugged to S2 female plug.

#### *Scenario D – Outside + Inside Triggering*

Low light intensity luminaires in the zone is controlled by a sensor positioned in the previous zone. High light intensity luminaires are controlled by a sensor in the same zone.

S1, S2 and S3 are plugged to grid by the help of a three-way multi plug socket.

L1 is plugged to S1; H1, L2 and L3 are plugged to S2; H3 is plugged to S3.

### **3.6. Procedure**

Each participant starts with an information session about the experiment. Controller 2 gives information about the procedure, then collects necessary information (age, gender, familiarity with the building) from the participants. The task each participant had to perform was walking from the start point until the finish point. The route was beginning with a ‘Start’ sign before the stairs outside which can be seen in Figure 3.4. After the stair’s participant had to pass two doors, interior door was permitting access by an ID card. Then the participant walks through the zone A and turns right to the zone C and goes down from the stairs and stop by the ‘Finish’ sign. At the end of the task participant had to evaluate the scenario. After the evaluation the participant goes back to the start point. Controller 1 illuminates the whole area during this transaction, then sets the next lighting control scenario ready and informs Controller 1. Participant repeats the same task 4 times for 4 different lighting control scenarios. Figure 3.11 shows schematically the procedure of the experiment. Experiment took 12-15 minutes

for one participant. All communications were made in Turkish language. At the end of the experiment, participants were given a coupon for a free coffee from a local coffee shop in appreciation for their efforts.

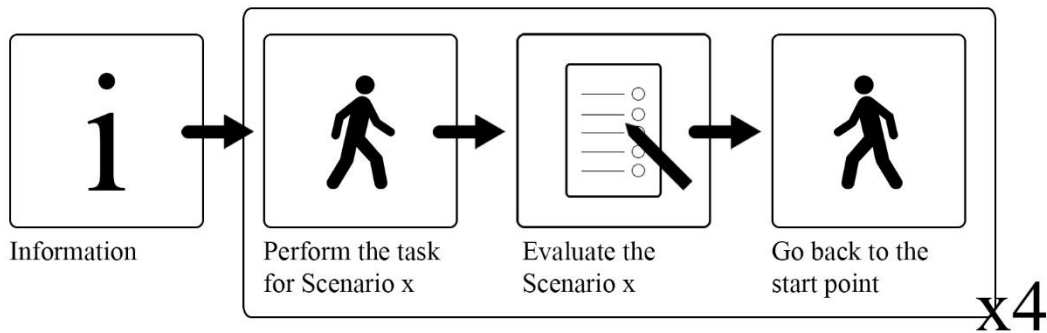

Figure 3.11. Procedure of the experiment.

### 3.7. Measures

In this section evaluation criteria for 4 different lighting scenarios are outlined. Participants were asked to evaluate each of the 4 lighting control scenarios after they completed the task. Energy saving potentials of these scenarios will also be compared.

#### 3.7.1. Evaluation of the scenarios

Participants evaluated the conditions by a questionnaire at the end of each scenario. All communications and evaluations were in Turkish language since it was the mother tongue of all participants. Appendix B presents this questionnaire in Turkish. The evaluation questionnaire consists of 10 questions (7-point Likert scale). The focus was on evaluating different lighting control strategies for circulation areas in the night use. There were no previous validated scales in the literature based on the assessment of lighting control systems in circulation areas or for night use. So, the questionnaire was structured based on literature knowledge on lighting quality, lighting for circulation areas and observations on night use by the researcher. In IESNA Lighting Handbook 9<sup>th</sup> edition, human needs served by lighting were presented (See section 2.1 for further

information). According to this handbook, human needs served by lighting are: visibility; task performance; mood and atmosphere; visual comfort; aesthetic judgment; health, safety, and well-being; and social communication. Among these criteria, Visibility, mood, atmosphere, well-being, sense of security and visual comfort were associated with the lighting control while other criteria were mostly based on other features of the lighting design. Among all, 'visibility' criterion was the main factor to ensure lighting quality. In terms of circulation areas, since the task was reaching one place to another, 'visibility criterion' becomes the leading factor especially in night use 'Sense of security' measure was added alone and found to be important, since both literature review and observations of the researcher indicate that rather than day use, night use may cause uneasy feeling at the occupants. Moreover, appraisal and acceptance were added as criteria to the evaluation measures to evaluate self-reported satisfaction levels as they were also suggested by other research (Bakker et al., 2018). These criteria were found to be suitable for this study, since the focus is on night time in circulation areas and lighting control differences only. The questionnaire was constructed according to these criteria. Eklund and Boyce (1996) developed a survey to assess lighting quality in offices. They explained the steps of development in their paper. In the first step, the evaluation criteria were specified and in the second step related statements were formulated. So, for this study, considering the example of Eklund and Boyce (1996), after determining the evaluation criteria, regarding statements were generated to evaluate them in a more solid way. To bring the evaluation questionnaire in its final version, a focus group study (a semi structured discussion with members of the targeted population guided by a moderator) was conducted with 6 master students in building science (Krueger & Casey, 2000). The purpose was to associate evaluation criteria to questionnaire statements. The statements (Table 3.4) were organized according to task (from the start point to finish point) to make evaluation easier for the participants.

Table 3.4. Evaluation questionnaire.

|    |  |                    |  |
|----|--|--------------------|--|
| 1  | The building entrance looked inviting.                               | Atmosphere Outside | 1 (Strongly Disagree) 7 (Strongly Agree) |
| 2  | I felt uneasy before entering the building.                          | Mood Outside       | 1 (Strongly Disagree) 7 (Strongly Agree) |
| 3  | I felt good after entering the building.                             | Well-being         | 1 (Strongly Disagree) 7 (Strongly Agree) |
| 4  | As I moved through the corridor, I easily perceived the environment. | Visual Comfort     | 1 (Strongly Disagree) 7 (Strongly Agree) |
| 5  | Places in my field of view made be nervous.                          | Mood inside        | 1 (Strongly Disagree) 7 (Strongly Agree) |
| 6  | The atmosphere made me feel comfortable.                             | Atmosphere Inside  | 1 (Strongly Disagree) 7 (Strongly Agree) |
| 7  | I noticed the stairs in time.  | Visibility         | 1 (Strongly Disagree) 7 (Strongly Agree) |
| 8  | In general, I was satisfied with this lighting control.              | Appraisal          | 1 (Strongly Disagree) 7 (Strongly Agree) |
| 9  | This lighting control was acceptable to me.                          | Acceptance         | 1 (Strongly Disagree) 7 (Strongly Agree) |
| 10 | This lighting control was reassuring.                                | Sense of security  | 1 (Strongly Disagree) 7 (Strongly Agree) |

### 3.7.2. Energy Saving Potentials

Energy saving potentials of the 4 different lighting control scenarios will be just compared in between to come up with an explorative evaluation. Making exact calculations on energy consumption of different lighting control scenarios is not possible and, scenario C and D are just explorative (they do not exist in sector nor they can be actualized by the existing automated lighting control technologies) so it also would not be possible to calculate their energy consumptions. So, the evaluation of

energy saving potentials will be made according to single occupancy scenarios for experimented time as user evaluation were also done accordingly.

### **3.8. Analysis**

This was a within subjects repeated measures design with 4 within subject factors (Independent Variables: Scenario A, B, C, D), 10 measures (Dependent Variables) and 37 subjects. To analyze if there is a significant difference between these scenarios by these dependent variables statistical analysis was carried on. In the evaluation of statistical methods, since there were more than 1 DV, there were two possible parametric approaches: doing multiple RM ANOVA (Repeated Measures Analysis of Variance) tests for each DV or doing a RM MANOVA (Repeated Measures Multivariate Analysis of Variance) test. RM MANOVA was suggested at this point since doing multiple ANOVAs may increase the type I Error risk (Schutz & Gessaroli, 1987). On the other hand, data of this research did not fit the assumptions of RM MANOVA. So, related non-parametric tests were considered since the data was ordinal and distribution of the data was not normal due nature of Likert scale. As there was no non-parametric statistical test in exchange for RM MANOVA, Friedman's test was chosen as it is the non-parametric version of RM ANOVA. Friedman's test was applied for each of the dependent variables to answer the research questions with a following post hoc analysis. To reduce the type I Error risk, Bonferroni correction was applied.

To create a single score from 10 DVs, summated scales (a data reduction method which creates a composite value by summing and averaging the original variables) were created (Hair, Black, Babin, & Anderson, 2014). This was accurate for the experimental nature of this study since there were multiple dependent variables which are different measures of the same construct and measured in the same scale. These scores were calculated for each of the experimental scenarios to compare the overall satisfaction levels and will be named from now on 'Overall Satisfaction Score'. It should be noted that, in the calculation of this score, ratings on the evaluation criteria

2 and 5 were recoded to achieve positive values (they were stated in a negative manner in the evaluation form).

IBM SPSS (Statistical Package for the Social Sciences) 23.0.0 was used for statistical analysis with a .05 level of statistical significance (p value).



## CHAPTER 4

### RESULTS AND DISCUSSION

In this chapter the results of the experiment will be presented to answer research questions with the suitable statistical analysis. Firstly, comparison on the energy saving potentials is calculated between the experimental lighting control scenarios. Then the results of the analysis on the overall satisfaction scores of the experimental scenarios were presented and median values were compared and discussed. After that, to find underlying factors causing satisfaction or dissatisfaction, all evaluation criteria were analyzed for the experimental scenarios and discussions are presented. Then results of the statistical analysis were presented for each of the evaluation measures and discussion is made.

#### 4.1. Comparison of the Energy Saving Potentials

In this section a comparison was presented between the experimental lighting control scenarios in terms of their energy saving potentials. This comparison will be based on logical calculations, since scenario C and D are not productized but realized in a simplistic manner for experimental purposes.

The below calculations show the approximate electrical energy consumption of 4 lighting control scenarios for 6 hours period (based on experiment hours between 8pm and 2am) and observed occupancy of 32 people. The time delay setting of the occupancy sensors are decided as 2 minutes (minimum time delay setting suggested in the literature), since it take 30-40 seconds to walk through this path. Energy used by the occupancy sensors is neglected in the calculations. The results would be different for different time periods, different occupancy patterns, different time delay settings and different lighting products. The calculation formula is shown below:

Amount of electrical energy used(kWh)=Power of the electrical device(kW)xtime (h)

*Scenario A*

$$0.014 \text{ (kW)} \times 6 \text{ (h)} \times 13 \text{ (quantity)} = 1.092 \text{ kWh}$$

$$\text{Annual consumption(A)} = 1.092 \times 2 \times 360 = 786.24 \text{ kWh}$$

*Scenario B*

$$32 \text{ (number of the occupants)} \times [(0.014 \text{ (kW)} \times 0.03 \text{ (h)} \times 6 \text{ (quantity)}) + (0.014 \text{ (kW)} \times 0.03 \text{ (h)} \times 5 \text{ (quantity)})] = 0.16427 \text{ kWh}$$

$$\text{Annual consumption(B)} = 0.16427 \times 2 \times 360 = 118.2744 \text{ kWh}$$

*Scenario C*

$$32 \text{ (number of the occupants)} \times [(0.014 \text{ (kW)} \times 0.03 \text{ (h)} \times 6 \text{ (quantity)}) + (0.014 \text{ (kW)} \times 0.03 \text{ (h)} \times 7 \text{ (quantity)})] = 0.19413 \text{ kWh}$$

$$\text{Annual consumption(C)} = 139.7736 \text{ kWh}$$

*Scenario D*

$$32 \text{ (number of the occupants)} \times [(0.014 \text{ (kW)} \times 0.03 \text{ (h)} \times 6 \text{ (quantity)}) + (0.003 \text{ (kW)} \times 0.03 \text{ (h)} \times 2 \text{ (quantity)}) + (0.003 \text{ (kW)} \times 0.008 \text{ (h)} \times 5 \text{ (quantity)}) + (0.014 \text{ (kW)} \times 0.03 \text{ (h)} \times 5 \text{ (quantity)})] = 0.17467 \text{ kWh}$$

$$\text{Annual consumption(D)} = 0.17467 \times 2 \times 360 = 125.7624 \text{ kWh}$$

To reveal annual energy consumption approximately in the off-operation hours (12 hours a day), these results are be multiplied with 360. The chart below (Figure 4.1) shows the annual energy consumption in dark hours.

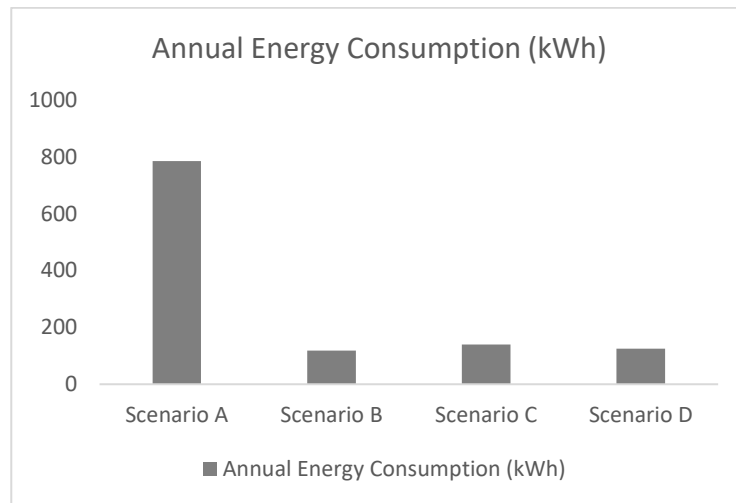

Figure 4.1. Annual energy consumption of the experimental scenarios.

According to results, scenario A has the lowest energy saving potential (ESP) since the lighting control is manual and lighting requires to be active 24 hours of a day because of the 24 hours of occupation. In Scenario B, conventional use of occupancy sensors, ensures lighting to be activated only in the occupied time. When it is considered that the delay times were fixed in all 3 occupancy sensor scenarios, this scenario has the highest potential for energy efficiency. In Scenario C and D, lighting situation of the zones is controlled by the sensors from the adjacent zones. So, compared to Scenario B, more than one zone (adjacent zones) becomes active when occupancy is detected. When Scenario C and D are compared, in Scenario D adjacent zones become dimly lit while in Scenario C adjacent zones become completely lit. So, it can be stated that Scenario D has a higher energy saving potential than Scenario C. To sum up;

ESP (Scenario B) > ESP (Scenario D) > ESP (Scenario C) > ESP (Scenario A).

## 4.2. Overall Satisfaction Scores

As it was explained in the previous chapter summated scales (Overall satisfaction score) were generated for each scenario to form a single evaluation score from multiple DVs (multiple Likert scale statements). A Friedman test was run to see if there is a difference between overall satisfaction scores of the 4 different experimental lighting control scenarios. Then pairwise comparisons were performed with a Bonferroni correction for multiple comparisons (As multiple comparisons increase the risk of a Type I error) (Conover, 1999). Overall satisfaction scores were statistically significantly different for different experimental lighting control scenarios,  $\chi^2(3) = 47.810, p < .001$ . As  $p < 0.001$ , there is a significant difference between at least two scenarios. Post hoc analysis revealed statistically significant differences in overall satisfaction scores from scenario B ( $Mdn = 3.40$ ) to scenario A ( $Mdn = 6.00$ ) ( $p < 0.0001$ ), from scenario B to scenario C ( $Mdn = 6.10$ ) ( $p < 0.0001$ ) and from scenario B to scenario D ( $Mdn = 6.20$ ) ( $p < 0.0001$ ). There were no significant differences between any other scenarios. Statistical results generated in SPSS can be seen in Appendix D. Figure 4.2 reports the median scores and the spread for experimental scenarios A, B, C and D. Since non-parametric tests were conducted and data was ordinal, median scores were used to compare results. As it can be observed there is an obvious difference between scenario B and scenario A, C, D. Scenario B is in the dissatisfaction range (score < 4).

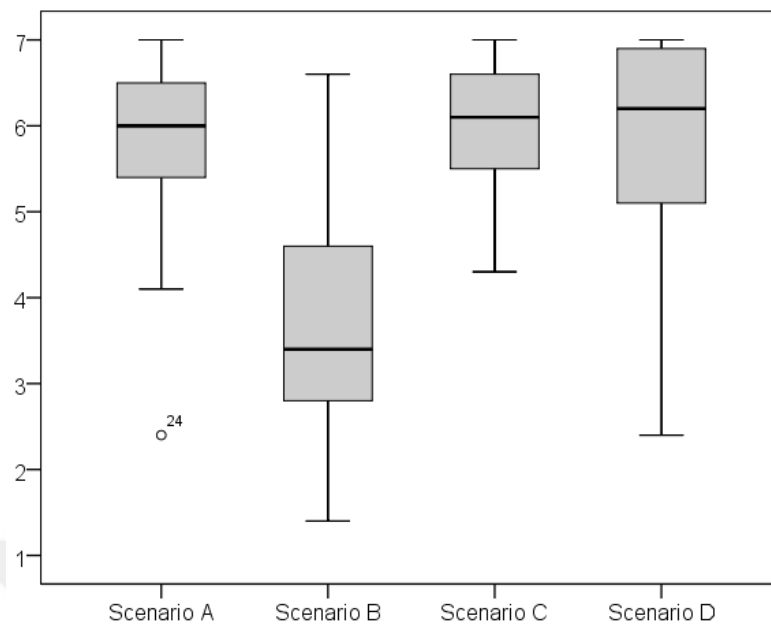

Figure 4.2. Median and range of overall satisfaction scores on 4 experimental lighting control scenarios (N=37).

This result reveals an answer for one of the research questions: conventional use of occupancy sensors (Scenario B) was not favored by the participants in night use. In the following sections related evaluation measures were presented to reveal underlying cause of this dissatisfaction on this scenario.

On the other hand, existing situation (Scenario A) and other proposed user-oriented sensor-based scenarios (Scenario C and D) were favored by the participants. The existing situation (Scenario A) where all lights were open all the time without a sensor control, was found to be favorable by the participants considering its median value of the overall satisfaction score. According to Friedman test, scenario C and D were also favorable by the participants and there was no significant difference between scenario A. This points out that, to achieve better energy efficiency, sensor-based lighting control systems can be used in the circulation areas without sacrificing user satisfaction when occupancy sensors are used in a user-friendly way. Scenario C was based on the idea of Scenario A. User steps in a lit environment and thus has lit areas

in the sight of view. These results also show that this is an important criterion for users to be satisfied in night use.

Between scenario C and D there were little statistically insignificant differences by their overall satisfaction scores. Regarding this result, it can be deduced that, for better energy efficiency scenario D based lighting control systems (outside + inside triggering) can be used without sacrificing user satisfaction. But since scenario D requires use of a dimming algorithm and dimmable products to realize this lighting control, it would have superior initial costs. So, choosing the optimum solution between these strategies may be different for different projects, considering different occupancy patterns, occupancy schedules and budgets.

### **4.3. Evaluation of the Scenarios**

In the previous section, overall satisfaction scores were presented, compared and discussed. In this section regarding evaluation scores of the experimental scenarios will be presented and discussed by each evaluation criterion.

### 4.3.1. Scenario A

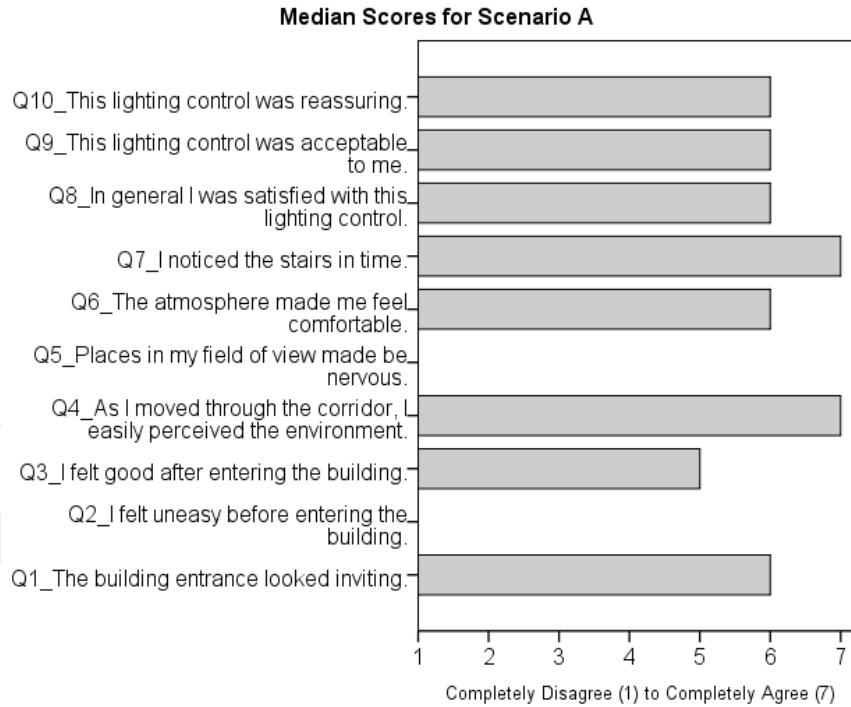

Figure 4.3. Median scores of the evaluation of Scenario A (N=37).

The bar chart in the Figure 4.3 shows the median ratings on each evaluation criterion. All criteria were in the favorable range (score>4). According to the results, this scenario was favored mostly for its visibility (Q7), visual comfort (Q5), outside mood (Q2recoded) and inside mood (Q5recoded) by median value of 7.00.

### 4.3.2. Scenario B

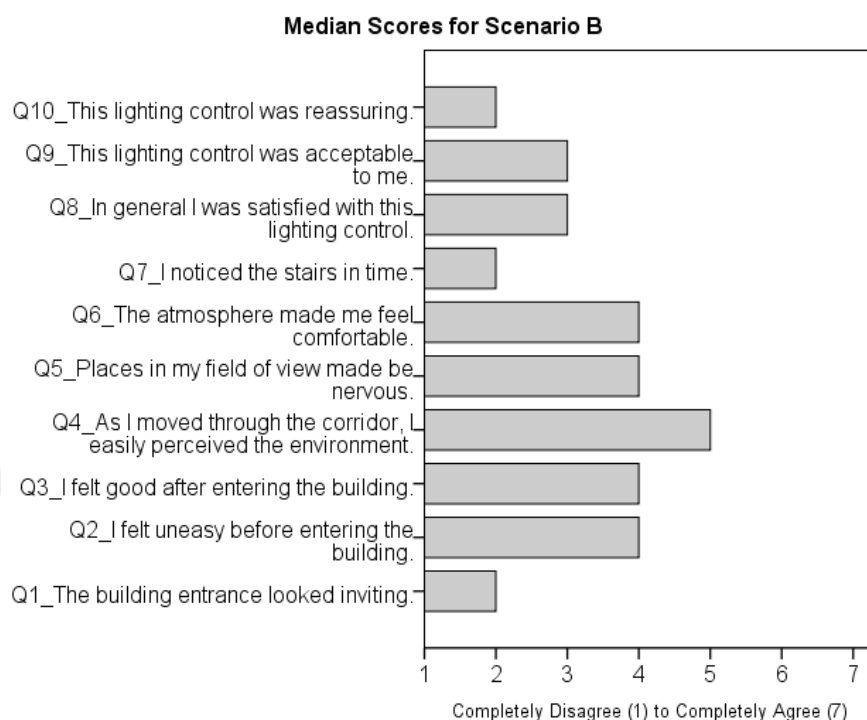

Figure 4.4. Median scores of the evaluation of Scenario B (N=37).

Regarding there were no significant differences between Scenario A, C and D in overall satisfaction scores and having the lowest overall satisfaction score; evaluation results of scenario B will be presented to understand underlying results of dissatisfaction. Figure 4.4 presents a bar chart showing the median scores of all 10 evaluation criteria. According these results, scenario B was disfavored by the participants mostly by outside atmosphere score ( $Mdn = 2.00$ ), visibility score ( $Mdn = 2.00$ ) and sense of security score ( $Mdn = 2.00$ ). Self-reported appraisal ( $Mdn = 3.00$ ) and acceptance ( $Mdn = 3.00$ ) scores also reveals dissatisfaction with this lighting control scenario. Only favorable criterion was visual comfort ( $Mdn = 5.00$ ). Inside atmosphere ( $Mdn = 4.00$ ), inside mood ( $Mdn = 4.00$ ), outside mood ( $Mdn = 4.00$ ) and well-being ( $Mdn = 4.00$ ) scores were all in the undecided range.

According to these results, underlying factors affecting the dissatisfaction of the participants revealed. In scenario B, participants were stepping into a dark environment and also were having dark spots in their field of view. On the other hand, in other 3 scenarios, participants were stepping into lit or semi lit areas and they were having lit or semi lit areas in their field of view. As this experiment carried on at night, it can be said that conventional use of occupancy sensor (Scenario B), was not favored by the participants due to being not inviting and giving lack of sense of security, visibility, well-being.

### 4.3.3. Scenario C

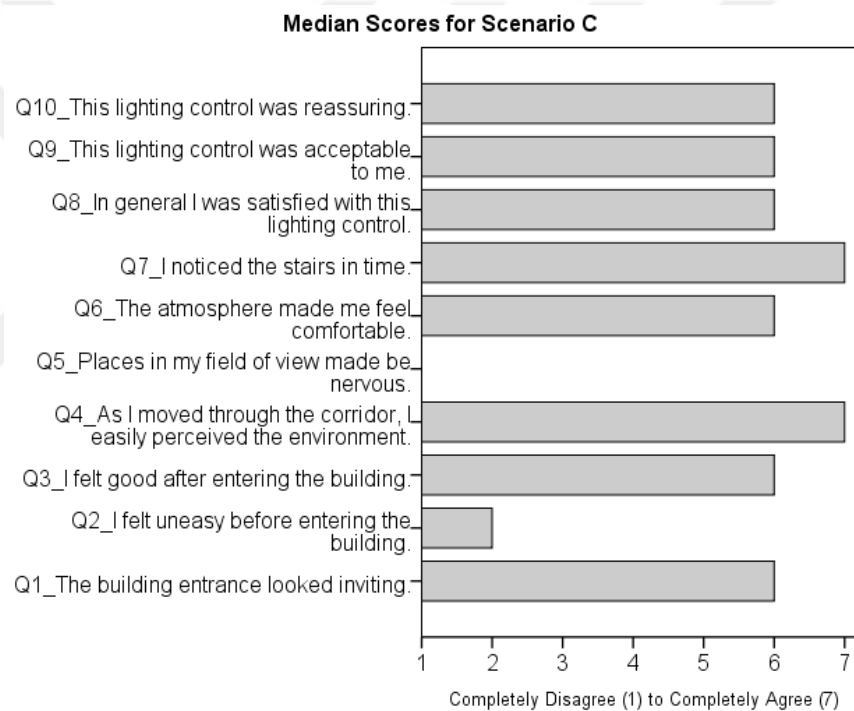

Figure 4.5. Median scores of the evaluation of Scenario C (N=37).

Figure 4.5 presents a bar chart showing the median values of the results on Scenario C. As it was in the Scenario A, rating for visibility (Q7), visual comfort (Q4) and inside mood (Q5recoded) has the highest scores by a median of 7.00. The other values were also favored by a median of 6.00. As this scenario was based on the experience

of Scenario A, these results were expected by the researcher. It can be pointed out that, resemblance of Scenario A and C, proves that occupancy sensor-based lighting control systems can be as reassuring as constantly lit environments.

#### 4.3.4. Scenario D

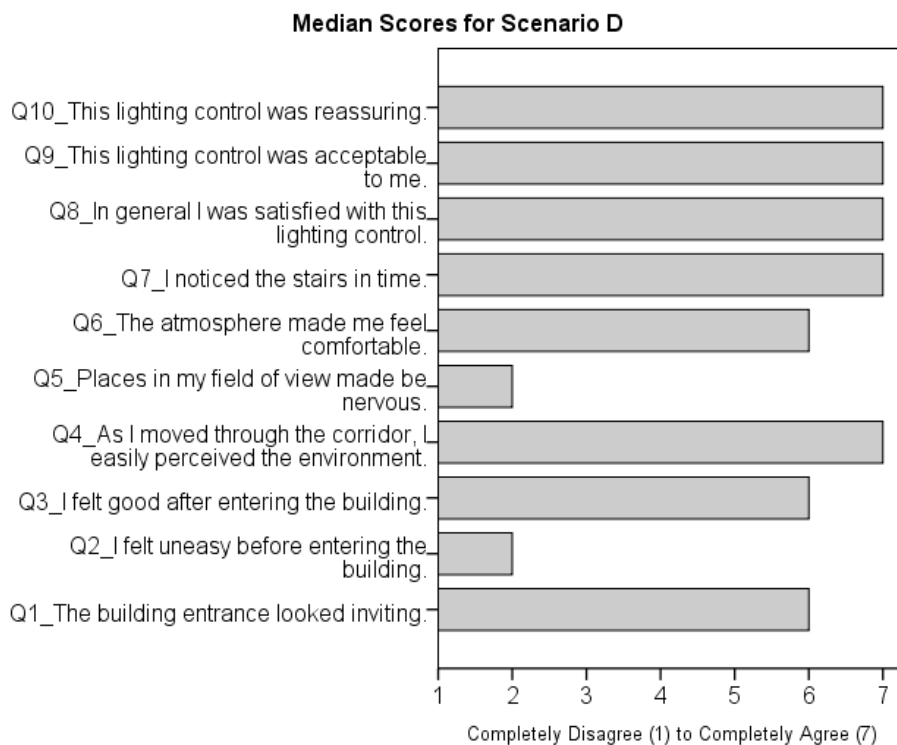

Figure 4.6. Median scores of the evaluation of Scenario D (N=37).

In the bar chart presented in Figure 4.6, evaluation results for Scenario D is shown by their median scores. Scenario D was favorable by the participant by lowest median of 6.00. While in the overall satisfaction scores, there were no statistically significant differences between Scenario A, C and D; this bar chart shows better evaluation on compared to others. In the following section results of the statistical analysis will be presented to compare each criterion by the experimental scenarios to see if there is a significant difference.

#### 4.4. Comparison of the Evaluation Criteria

In this section results of each evaluation criteria will be presented with the regarding statistical analysis to see if there is a significant difference. Then results will be discussed. In Appendix E, statistical results generated in SPSS can be found.

##### 4.4.1. Outside Atmosphere

This criterion was measured by the statement ‘Building entrance looked inviting’ by a 7-point Likert scale. A Friedman test was run to see if there is a difference between the ‘outside atmosphere’ scores of the 4 different experimental lighting control scenarios. Outside atmosphere scores were statistically significantly different for different experimental lighting control scenarios,  $\chi^2(3) = 49.020, p < .001$ . As  $p < 0.001$ , there is a significant difference between at least two scenarios. Post hoc analysis revealed statistically significant differences in scores from scenario B ( $Mdn = 2.00$ ) to scenario A ( $Mdn = 6.00$ ) ( $p < 0.0001$ ), from scenario B to scenario C ( $Mdn = 6.00$ ) ( $p < 0.0001$ ) and from scenario B to scenario D ( $Mdn = 6.00$ ) ( $p < 0.0001$ ). There were no significant differences between any other scenarios. In Figure 4.7, evaluation scores are presented in a bar chart for Scenario A, B, C and D.

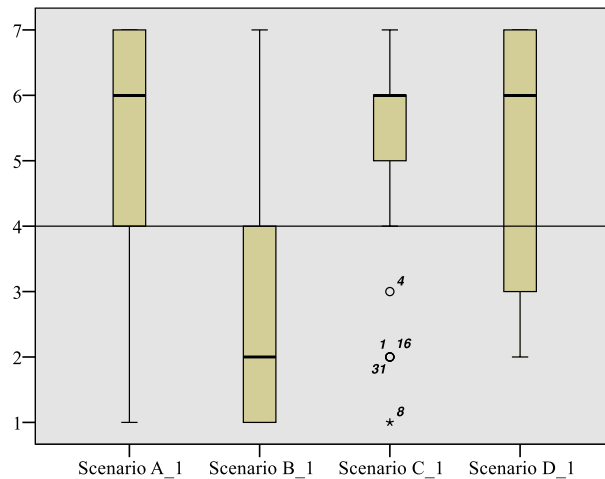

Figure 4.7. Median scores for ‘Outside Atmosphere’.

#### 4.4.2. Outside Mood

This criterion was measured by the statement ‘I felt uneasy before entering the building’ by a 7-point Likert scale. Since it is a negative statement, it is recoded before the analysis to bring easily read the results. A Friedman test was run to see if there is a difference between the ‘outside mood’ scores of the 4 different experimental lighting control scenarios. Outside mood scores were statistically significantly different for different experimental lighting control scenarios,  $\chi^2(3) = 45.807, p < .001$ . As  $p < 0.001$ , there is a significant difference between at least two scenarios. Post hoc analysis revealed statistically significant differences in scores from scenario B ( $Mdn = 4.00$ ) to scenario A ( $Mdn = 7.00$ ) ( $p < 0.0001$ ), from scenario B to scenario C ( $Mdn = 6.00$ ) ( $p < 0.0001$ ) and from scenario B to scenario D ( $Mdn = 6.00$ ) ( $p = 0.0004$ ). There were no significant differences between any other scenarios. In Figure 4.8, evaluation scores are presented in a bar chart for Scenario A, B, C and D.

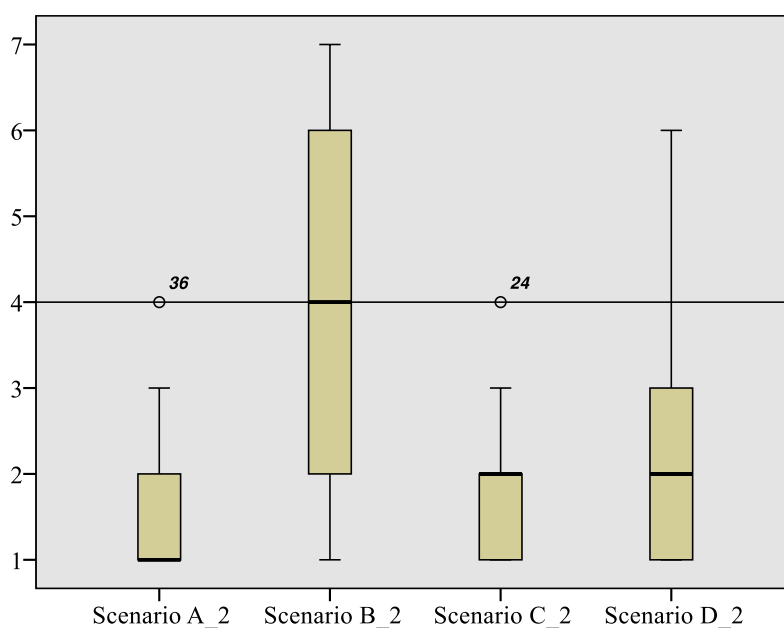

Figure 4.8. Median scores for ‘Mood Outside’.

### 4.4.3. Well-being

This criterion was measured by the statement ‘I felt good after entering the building’ by a 7-point Likert scale. A Friedman test was run to see if there is a difference between the ‘well-being’ scores of the 4 different experimental lighting control scenarios. Well-being scores were statistically significantly different for different experimental lighting control scenarios,  $\chi^2(3) = 22.215, p < .001$ . As  $p < 0.001$ , there is a significant difference between at least two scenarios. Post hoc analysis revealed statistically significant differences in scores from scenario B ( $Mdn = 4.00$ ) to scenario C ( $Mdn = 6.00$ ) ( $p < 0.005$ ) and from scenario B to scenario D ( $Mdn = 7.00$ ) ( $p = 0.05$ ). There were no significant differences between any other scenarios. In Figure 4.9, evaluation scores are presented in a bar chart for Scenario A, B, C and D.

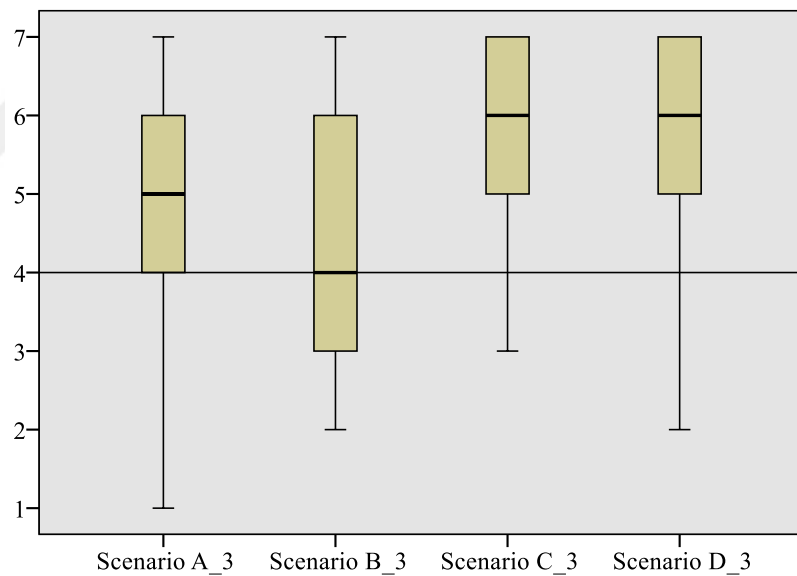

Figure 4.9. Median scores for ‘well-being’.

#### 4.4.4. Visual Comfort

This criterion was measured by the statement ‘As I moved through the corridor, I easily perceived the environment’ by a 7-point Likert scale. A Friedman test was run to see if there is a difference between the ‘visual comfort’ scores of the 4 different experimental lighting control scenarios. Visual comfort scores were statistically significantly different for different experimental lighting control scenarios,  $\chi^2(3) = 34.369, p < .001$ . As  $p < 0.001$ , there is a significant difference between at least two scenarios. Post hoc analysis revealed statistically significant differences in scores from scenario B ( $Mdn = 5.00$ ) to scenario A ( $Mdn = 7.00$ ) ( $p < 0.0001$ ), from scenario B to scenario C ( $Mdn = 7.00$ ) ( $p < 0.0001$ ) and from scenario B to scenario D ( $Mdn = 7.00$ ) ( $p < 0.0005$ ). There were no significant differences between any other scenarios. In Figure 4.10, evaluation scores are presented in a bar chart for Scenario A, B, C and D.

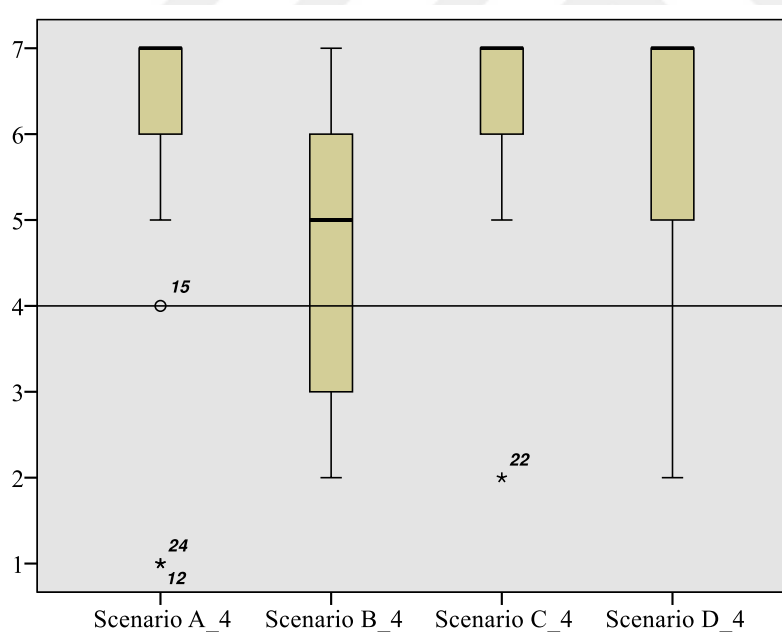

Figure 4.10. Median scores for ‘visual comfort’.

#### 4.4.5. Mood Inside

This criterion was measured by the statement ‘Places in my field of view made me nervous’ by a 7-point Likert scale. Since it is a negative statement, it is recoded before the analysis to easily read the results. A Friedman test was run to see if there is a difference between the ‘inside mood’ scores of the 4 different experimental lighting control scenarios. Inside mood scores were statistically significantly different for different experimental lighting control scenarios,  $\chi^2(3) = 37.312, p < .001$ . As  $p < 0.001$ , there is a significant difference between at least two scenarios. Post hoc analysis revealed statistically significant differences in scores from scenario B ( $Mdn = 4.00$ ) to scenario A ( $Mdn = 6.00$ ) ( $p < 0.0001$ ), from scenario B to scenario C ( $Mdn = 6.00$ ) ( $p < 0.0001$ ) and from scenario B to scenario D ( $Mdn = 5.00$ ) ( $p < 0.05$ ). There were no significant differences between any other scenarios. In Figure 4.11, evaluation scores are presented in a bar chart for Scenario A, B, C and D.

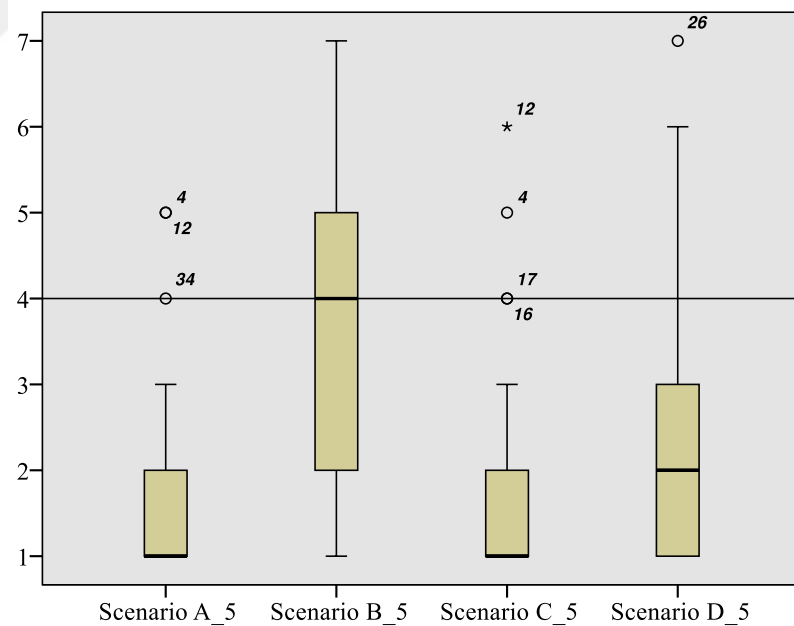

Figure 4.11. Median scores for ‘mood inside’.

#### 4.4.6. Atmosphere Inside

This criterion was measured by the statement ‘The atmosphere made feel comfortable’ by a 7-point Likert scale. A Friedman test was run to see if there is a difference between the ‘atmosphere inside’ scores of the 4 different experimental lighting control scenarios. Inside atmosphere scores were statistically significantly different for different experimental lighting control scenarios,  $\chi^2(3) = 36.237, p < .001$ . As  $p < 0.001$ , there is a significant difference between at least two scenarios. Post hoc analysis revealed statistically significant differences in scores from scenario B ( $Mdn = 4.00$ ) to scenario A ( $Mdn = 6.00$ ) ( $p < 0.005$ ), from scenario B to scenario C ( $Mdn = 6.00$ ) ( $p < 0.0001$ ) and from scenario B to scenario D ( $Mdn = 6.00$ ) ( $p < 0.0001$ ). There were no significant differences between any other scenarios. In Figure 4.12, evaluation scores are presented in a bar chart for Scenario A, B, C and D.

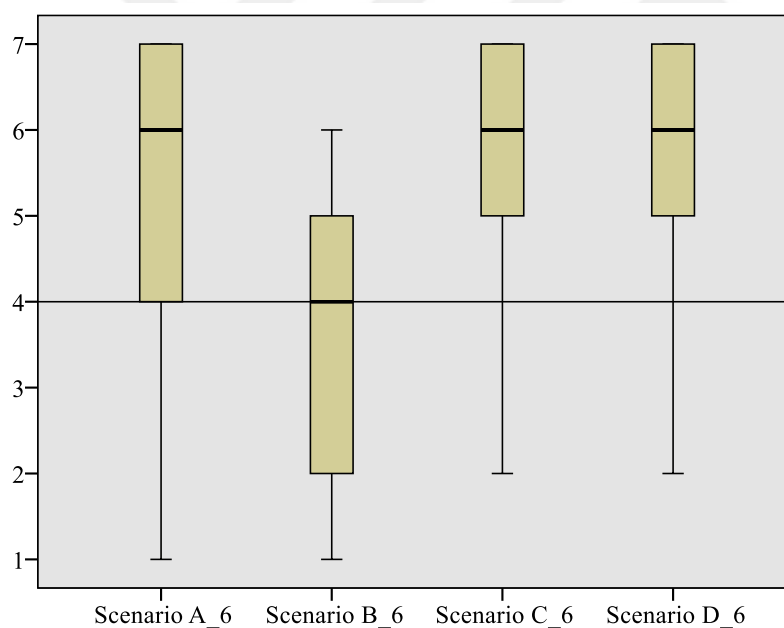

Figure 4.12. Medians scores for ‘inside atmosphere’

#### 4.4.7. Visibility

This criterion was measured by the statement ‘I noticed the stairs in time’ by a 7-point Likert scale. A Friedman test was run to see if there is a difference between the ‘visibility’ scores of the 4 different experimental lighting control scenarios. Visibility scores were statistically significantly different for different experimental lighting control scenarios,  $\chi^2(3) = 57.023, p < .001$ . As  $p < 0.001$ , there is a significant difference between at least two scenarios. Post hoc analysis revealed statistically significant differences in scores from scenario B ( $Mdn = 2.00$ ) to scenario A ( $Mdn = 7.00$ ) ( $p < 0.0001$ ), from scenario B to scenario C ( $Mdn = 7.00$ ) ( $p < 0.0001$ ) and from scenario B to scenario D ( $Mdn = 7.00$ ) ( $p < 0.0001$ ). There were no significant differences between any other scenarios. In Figure 4.13, evaluation scores are presented in a bar chart for Scenario A, B, C and D.

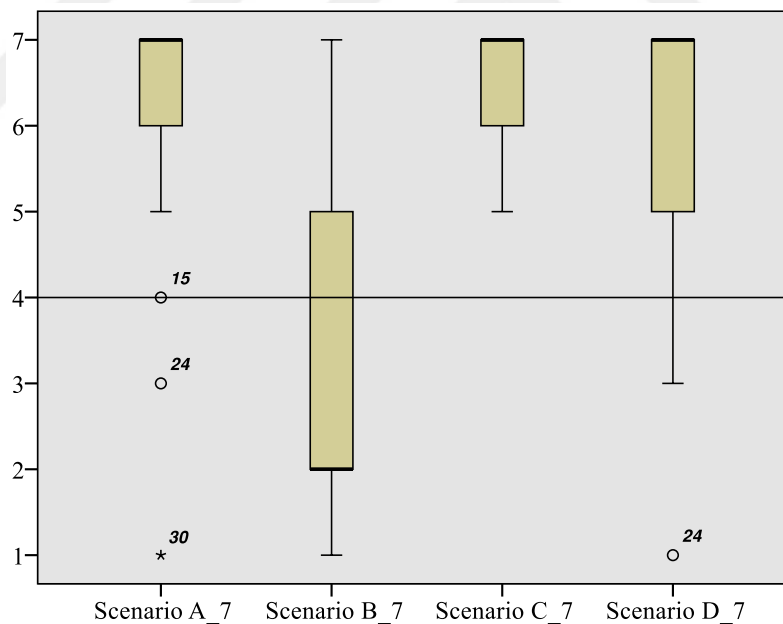

Figure 4.13. Median scores for ‘visibility’.

#### 4.4.8. Appraisal

This criterion was measured by the statement ‘In general, I was satisfied with this lighting control’ by a 7-point Likert scale. A Friedman test was run to see if there is a difference between the ‘appraisal’ scores of the 4 different experimental lighting control scenarios. Appraisal scores were statistically significantly different for different experimental lighting control scenarios,  $\chi^2(3) = 39.059, p < .001$ . As  $p < 0.001$ , there is a significant difference between at least two scenarios. Post hoc analysis revealed statistically significant differences in scores from scenario B ( $Mdn = 3.00$ ) to scenario A ( $Mdn = 6.00$ ) ( $p < 0.0001$ ), from scenario B to scenario C ( $Mdn = 6.00$ ) ( $p < 0.0001$ ) and from scenario B to scenario D ( $Mdn = 7.00$ ) ( $p < 0.0001$ ). There were no significant differences between any other scenarios. In Figure 4.14, evaluation scores are presented in a bar chart for Scenario A, B, C and D.

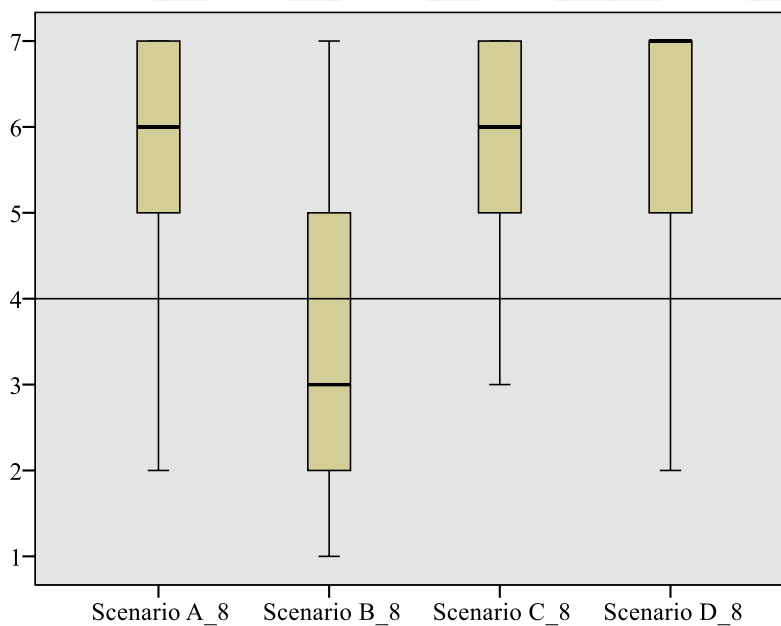

Figure 4.14. Median scores for ‘appraisal’.

#### 4.4.9. Acceptance

This criterion was measured by the statement ‘This lighting control was acceptable for me’ by a 7-point Likert scale. A Friedman test was run to see if there is a difference between the ‘acceptance’ scores of the 4 different experimental lighting control scenarios. Acceptance scores were statistically significantly different for different experimental lighting control scenarios,  $\chi^2(3) = 45.542, p < .001$ . As  $p < 0.001$ , there is a significant difference between at least two scenarios. Post hoc analysis revealed statistically significant differences in scores from scenario B ( $Mdn = 3.00$ ) to scenario A ( $Mdn = 6.00$ ) ( $p < 0.0001$ ), from scenario B to scenario C ( $Mdn = 6.00$ ) ( $p < 0.0001$ ) and from scenario B to scenario D ( $Mdn = 7.00$ ) ( $p < 0.0001$ ). There were no significant differences between any other scenarios. In Figure 4.15, evaluation scores are presented in a bar chart for Scenario A, B, C and D.

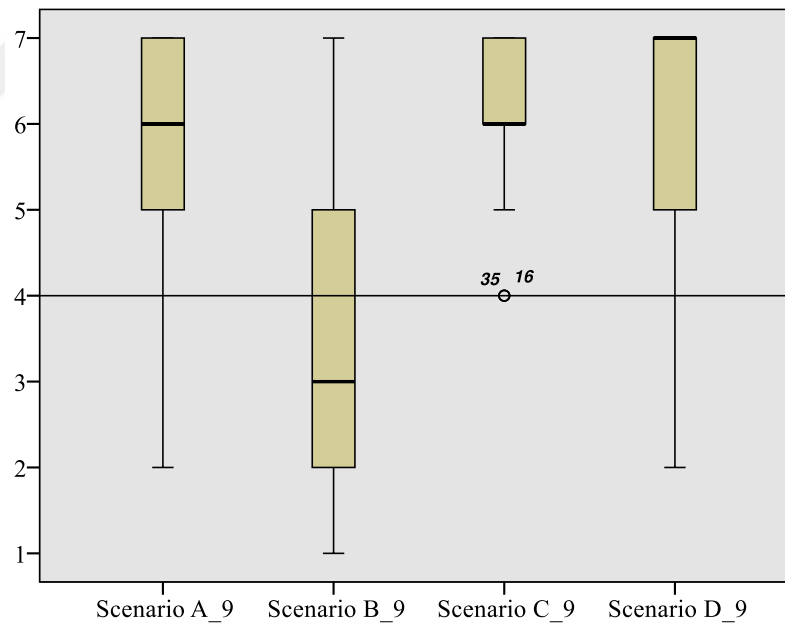

Figure 4.15. Median scores for ‘acceptance’.

#### 4.4.10. Sense of security

This criterion was measured by the statement ‘This lighting control was reassuring’ by a 7-point Likert scale. A Friedman test was run to see if there is a difference between the ‘sense of security’ scores of the 4 different experimental lighting control scenarios. Sense of security scores were statistically significantly different for different experimental lighting control scenarios,  $\chi^2(3) = 56.929, p < .001$ . As  $p < 0.001$ , there is a significant difference between at least two scenarios. Post hoc analysis revealed statistically significant differences in scores from scenario B ( $Mdn = 2.00$ ) to scenario A ( $Mdn = 6.00$ ) ( $p < 0.0001$ ), from scenario B to scenario C ( $Mdn = 6.00$ ) ( $p < 0.0001$ ) and from scenario B to scenario D ( $Mdn = 7.00$ ) ( $p < 0.0001$ ). There were no significant differences between any other scenarios. In Figure 4.16, evaluation scores are presented in a bar chart for Scenario A, B, C and D.

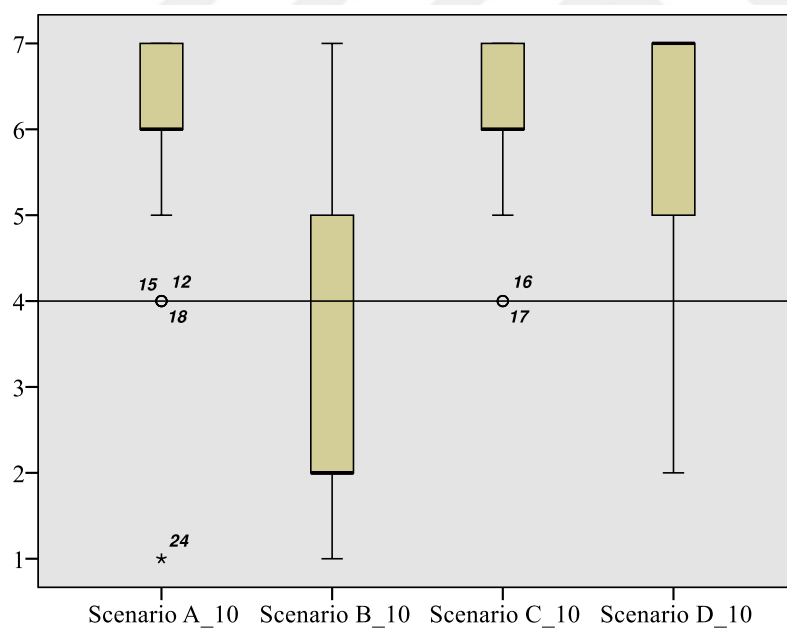

Figure 4.16. Median scores for ‘sense of security’.

#### 4.4.11. Discussion

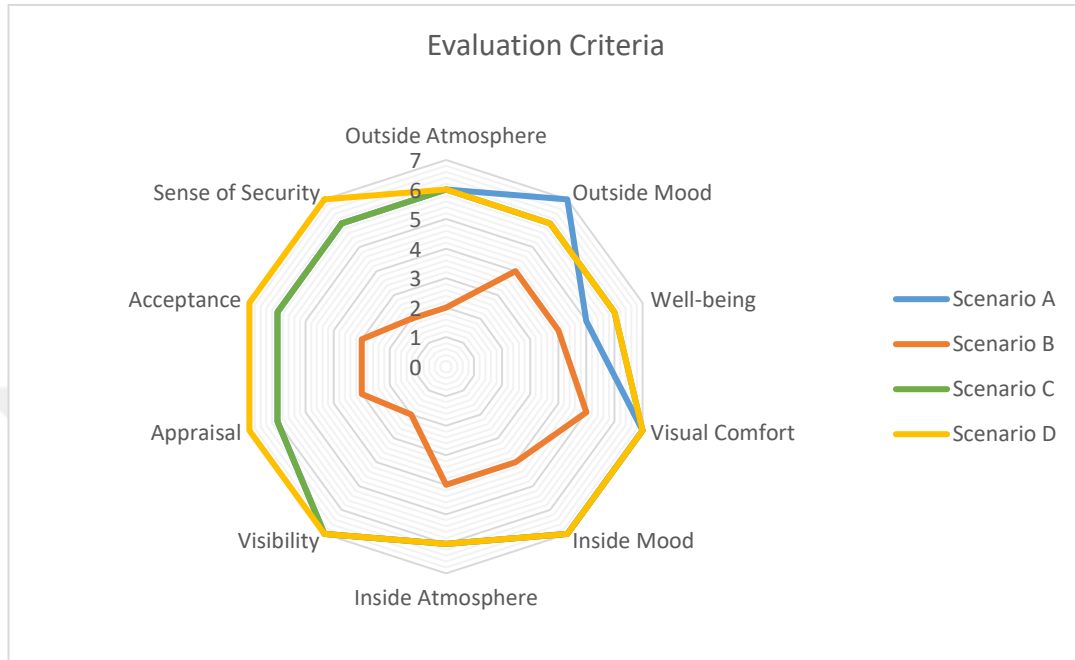

Figure 4.17. Spider chart representing the evaluation criteria in terms of experimental scenarios.

All statistical results are presented in Figure 4.17 for each of the evaluation criteria with their median values. Question 2 and 5 were converted to positive numbers to visualize the results in an easier way. As it can be seen, almost the same result is deducted as overall satisfaction score. There are statistically significant differences only between Scenario B and Scenario A, C, D. While in criteria 1 (outside atmosphere), 7 (visibility), 8 (appraisal), 9 (acceptance), 10 (sense of security) there were obvious differences by their median scores, in criteria 2 (outside mood), 3 (well-being), 4 (visual comfort), 5 (inside mood), 6 (inside atmosphere) the differences were not so definite. So, it can be highlighted that measures of giving an inviting entrance, providing sufficient visibility and sense of security are the most important criteria in terms of user satisfaction in dark hours.

Only in Scenario B, which was the conventional use of occupancy sensors, participants confronted a dark entrance when they were climbing the stairs. Results show that entrance was not inviting for the participants. In the daytime use, this would be acceptable for the users, but in the night use confronting a dark area causes discomfort. Moreover, in Scenario B, when participants walked through the corridor (Zone 1), the neighbored zones (Zone 2 and 3) were dark. So, it can be stated that, even though the participants were inside of a lit area, surrounding dark areas in their sight causes discomfort. In this regard, improved sensor-based scenarios (Scenario C and D) were successful as they offered an already lit entrance and prevented the dark spots in the sight of view. That provided better “sense of security” to the participants.

Even though there are no statistical differences between Scenario C and D; there are differences in terms of their median evaluation scores in terms of sense of security, acceptance and appraisal in favor of Scenario D. This reveals that, while Scenario C and D has the same evaluation scores, participants self-reported that they accepted scenario D better.

On the other hand, “visibility” criterion was not favorable in Scenario B, even though participants perceived adjacent zones immediately. This shows that, in interrelated circulation areas as this experiment area, it is more satisfying for the users, to perceive clearly the surrounding areas (areas in their sight of view). This is another important criterion for circulation areas in night use.

## CHAPTER 5

### CONCLUSION

In this chapter, firstly the summary of the research is presented. Then, the main results are outlaid along with the discussions. After that, limitations of the study are stated and finally, future further research directions are highlighted.

#### 5.1. Summary of the Research

User satisfaction and acceptance of energy efficient building technologies have gained a lot more importance recently in the literature. It is known that engagement of energy efficient building technologies is only possible if they serve for physical and psychological needs of the occupants. In the lighting sector, energy efficient lighting control strategies were mainly focused on energy savings and user satisfaction was neglected and that caused problems in the engagement of these energy efficient lighting control systems. Sensor based lighting control strategies are one example of them.

METU FA is a building that is operated 24 hours a day and regardless of the occupancy pattern (which is not steady) its circulation areas are illuminated for 24 hours a day to ensure user comfort. This causes a lot of energy waste. Use of sensor-based lighting control strategies are offered by the building codes at this point to overcome this problem. However, as it was also addressed in the literature, conventional use of occupancy sensors may cause dissatisfaction in circulation areas and this dissatisfaction is believed to be greater in the night use. In the literature, there is a lot of research on energy savings by different kind of occupancy sensors and application scenarios. However, there is lack of literature on the user evaluation of occupancy sensors in circulation areas. There are several recent researches in the literature on improving user satisfaction by proposing different time delay solutions, minimum and

maximum light levels and different fading times. These studies provide valuable input on improving energy efficient lighting control technologies by the user point of view. However, there is no specific study on the evaluation of the occupancy sensors in circulation areas at night use. It is believed that since dark hours may create different emotional responses on the occupants, this is an important research area to improve development on the issue. In the conventional use of occupancy sensors, occupants need to step inside of a dark area before the sensor triggers and that may cause dissatisfaction. Moreover, they confront dark spots in their sight of view which is believed to be another reason of dissatisfaction in night use.

So, in this research the aim was to experiment 4 different lighting control scenarios which were based on different configurations of sensors and zone of luminaires (different triggering scenarios). The scenarios were constructed to evaluate effects of stepping inside of a dark, lit and semi lit area and effects of having dark lit and semi lit areas in the sight of view. Another objective was to compare the existing situation to sensor-based scenarios. Underlying criteria causing satisfaction and dissatisfaction is also questioned.

The first scenario (Scenario A) was the current lighting control situation with no sensors, the second one (Scenario B) was conventional use of occupancy sensors (inside triggering). The third and fourth scenarios were based on outside triggering where lighting in an area is controlled by the sensors in the adjacent areas which prevents users stepping into a dark area and confronting dark spots in their sight of view. In the third scenario (Scenario C), a sensor triggered in an area, activates the luminaires fully lit in the adjacent areas. In the fourth scenario (Scenario D), a sensor triggered in an area, activates the luminaires to be dimly lit in the adjacent areas and when user steps in another sensor in that area turns luminaire to fully lit.

These 4 experimental lighting control scenarios were tested by a within subjects repeated measures design by 37 participants in the METU FA building. The experiments took place at dark hours and each participant had to experience all 4

experimental scenarios and make an evaluation for each of them. The comparison on energy saving potentials and initial cost of applications of these experimental scenarios were also made and results were discussed accordingly.

## 5.2. Main Results and Discussions

The main objective of this study was to compare and evaluate sensor-based lighting control system in terms of different triggering scenarios in circulation areas in night time. In this section, main results are listed below with the regarding discussions:

- There was a statistically significant difference between the overall satisfaction scores of Scenario B and the other scenarios and Scenario B was disfavored by the participants. So, it can be said that, conventional use of occupancy sensors causes dissatisfaction in circulation areas at night use.
- Based on the evaluation criteria scores, conventional use of occupancy sensor (Scenario B) was not favored by the participants due to being not inviting and giving lack of sense of security, visibility, well-being.
- Scenario C was based on the idea of Scenario A since participants would feel like being in a constantly lit environment when they experience this scenario. And since there was no statistically significant difference in the overall satisfaction scores between Scenario C and A, it can be pointed out that the intention was met. And they were both rated as favorable ( $Mdn = 6.00, 6.10$  respectively). This result shows, using better energy efficient lighting control systems are possible without sacrificing the user satisfaction and user-oriented occupancy sensor-based lighting control systems (Scenario C) can be as reassuring as constantly illuminated manual control systems (Scenario A).
- There was also no statistically significant difference in overall satisfaction score between Scenario C and D. As it is pointed out, as Scenario D would be more energy efficient, it can be preferred. But since it requires higher cost of

applications, the optimum solution would change according to actual implementation.

- The dissatisfaction and satisfaction differences were mostly on the criteria: 1 (outside atmosphere), 7 (visibility), 8 (appraisal), 9 (acceptance), 10 (sense of security) when they were compared by their medians in the experimental scenarios.

### **5.3. Limitations of the Study**

The experiment was designed as a within subjects repeated measures design, where the same subject experiences different lighting control scenarios for 4 times one after the other. This may lead to inaccuracy in participants' evaluations of these scenarios due to repeating the same task more than once. Practice effect may result in misevaluation of the first experienced scenarios and fatigue effect may result in misevaluating the last experienced scenarios. This could be seen as a limitation in this study. To reduce these affects, scenario B, C and D were experienced in a different order by the participants while scenario A was always the first scenario to create a baseline for all participants, as comparing sensor-based scenarios was the primary concern of this study.

Experimental lighting control scenarios were tested in a limited area to ensure control over user traffic and lighting conditions of the areas in the sight of view. Even though, the experiment took place in an actual area in an actual building that is used in night hours, limited experimental setting area of the circulation areas may not be enough to reveal actual feedback. Limited exposure time to experimental scenarios may also not be sufficient to measure user satisfaction for certain. The experiments were carried on by a single occupancy scenario to test the conditions in the most extreme case but being aware of being in an experimental setup may not reveal the actual satisfaction or dissatisfaction levels of the participants. These can be seen as limitations in this study.

In the realization of the experimental scenarios, setting was done in a simple manner just to test user satisfaction level between different triggering and zoning scenarios. So, other parameters of occupancy sensors were constant such as: delay time, fading time, accuracy level and position of the sensor. Moreover, to realize scenario D, two type of LED lamps (low and high intensity) were used to give impression of dimming. There was no fading time between minimum and maximum light level. From the literature we know, fading time between minimum and maximum light levels may affect user satisfaction, so this can be seen as another limitation in this study. Moreover, the lamps used in the experiment were chosen as the present highest and lowest intensity LED light bulbs in the sector to give right impression of the scenario D. The high intensity light bulbs were too much for the circulation areas. Scenario D, may be tested in a more complex scenario in accepted illumination levels, fading levels and real dimming, to get more accurate results.

Moreover, the experimental scenarios were designed to work one way, so realization of scenario C and D may be problematic with the current automated lighting technologies (DALI system). They require a new system design and algorithm to be realized. While this is a limitation, this may also be considered as a lead for developing new technology.

The comparison of the scenarios in terms of their energy consumptions could be done only hypothetically, since exact calculations for sensor-based scenarios (scenario B, C and D) was not possible. Moreover, scenario C and D were not actually existed in the market as products, they were tested for experimental purposes. So, their energy consumptions may only be compared by simple calculations. This is another limitation of this study.

Regarding the explorative nature of this study, the evaluation criteria was specified by the researcher since there were no rating scale based on lighting control neither for circulation areas nor for night use. The literature knowledge, the preliminary survey

study and discussions led to this evaluation questionnaire form. This may be considered as a limitation for the validation of the evaluation.

#### **5.4. Recommendations for Further Research**

Researchers are mainly recommended to address limitations presented above for further research. The main outcome of this study was that conventional use of occupancy sensors are not favored by the users in a circulation area at night use. The reasons of dissatisfaction were outlaid by necessary comparisons and related evaluation criteria in the results sections. Based on this information, improvement studies on the issue can be structured.

Productized versions of scenario C and scenario D should be used to experiment these scenarios again to understand more deeply the strengths and drawbacks. In this research, single person scenario was tested with one-way experience, the same scenarios may be tested with two-way experience and multiple participants. To reveal better outcome, this experiment may be set in a larger area and scenarios can be tested in the actual use for some amount of time.

In this research energy saving potentials and user evaluations were presented and compared. A comparison on initial application costs would be beneficial for lighting designers. Moreover, energy saving potentials are compared just by logic, more accurate comparison can be made through simulations or measurements in a real setup.

Moreover, application of wayfinding lighting elements for emergency situations is another important system that should be integrated with the general lighting control system. Further research may be carried on integrating energy saving lighting control systems with wayfinding systems.

According to results, it was found that sensor-based control scenarios could be as reassuring as keeping all lights on all the time. Scenario C and D were rated as reassuring as Scenario A. In this regard, further research can be done on these scenarios, focusing on other aspects to improve them. For scenario D, the experiment

can be replicated by actual dimming. So, effects of having different fading times, different delay time, different levels of illuminations and different zoning scenarios can be tested in terms on user satisfaction and energy efficiency.

Realization of proposed user centric sensor-based lighting control systems was done with electrical equipment shows that, these systems were more acceptable and convenient for the users. Even though, it is known that this system could not be realized through the existing automation systems (such as DALI), these systems were realized through simple electrical equipment. Developers and manufacturers may focus on automating these kind of user centric systems based on this study.





## REFERENCES

- Bakker, C. de, Voort, T. van de, Rosemann, A., de Bakker, C., van de Voort, T., & Rosemann, A. (2017). The Energy Saving Potential of Occupancy-Based Lighting Control Strategies in Open-Plan Offices: The Influence of Occupancy Patterns. *Energies*, *11*(1), 2. <https://doi.org/10.3390/en11010002>
- Barton, J. (1994). Choosing to Work at Night: A Moderating Influence on Individual Tolerance to Shift Work. *Journal of Applied Psychology*, *79*(3), 449–454. <https://doi.org/10.1037/0021-9010.79.3.449>
- Bellia, L., Fragliasso, F., & Pedace, A. (2015). Lighting control systems: factors affecting energy savings' evaluation. *Energy Procedia*, *78*, 2645–2650. <https://doi.org/10.1016/j.egypro.2015.11.336>
- Benya, J., Hescong, L., McGowan, T., Miller, N., & Rubinstein, F. (2003). *Advanced Lighting Guidelines* (2001st ed.). White Salmon: New Buildings Institute, Inc. Retrieved from [http://www.lightingassociates.org/i/u/2127806/f/tech\\_sheets/advanced\\_lighting\\_guidelines\\_2001.pdf](http://www.lightingassociates.org/i/u/2127806/f/tech_sheets/advanced_lighting_guidelines_2001.pdf)
- Berson, D. M., Dunn, F. A., & Takao, M. (2002). Phototransduction by Retinal Ganglion Cells That Set the Circadian Clock. *Science*, *295*(5557), 1070–1073. <https://doi.org/10.1126/SCIENCE.1067262>
- Borisuit, A., Linhart, F., Scartezzini, J.-L., & Münch, M. (2015). Effects of realistic office daylighting and electric lighting conditions on visual comfort, alertness and mood. *Lighting Research & Technology*, *47*(2), 192–209. <https://doi.org/10.1177/1477153514531518>
- Boyce, P. R., Veitch, J. A., Newsham, G. R., Jones, C. C., Heerwagen, J., Myer, M., & Hunter, C. M. (2006). Lighting quality and office work: two field simulation experiments. *Lighting Research & Technology*, *38*(3), 191–223. <https://doi.org/10.1191/1365782806lrt161oa>

- Brox, J. (2010). *Brilliant : the evolution of artificial light* (1st ed.). New York: Houghton Mifflin Harcourt. Retrieved from [https://books.google.com.tr/books?id=523HOwEO13YC&dq=brilliant+jane+brox&source=gbs\\_navlinks\\_s](https://books.google.com.tr/books?id=523HOwEO13YC&dq=brilliant+jane+brox&source=gbs_navlinks_s)
- Byun, J., Hong, I., Lee, B., & Park, S. (2013). Intelligent household LED lighting system considering energy efficiency and user satisfaction. *IEEE Transactions on Consumer Electronics*, 59(1), 70–76. <https://doi.org/10.1109/TCE.2013.6490243>
- Byun, J., & Shin, T. (2018). Design and Implementation of an Energy-Saving Lighting Control System Considering User Satisfaction. *IEEE Transactions on Consumer Electronics*, 64(1), 61–68. <https://doi.org/10.1109/TCE.2018.2812061>
- Chellappa, S. L., Steiner, R., Blattner, P., Oelhafen, P., Götz, T., & Cajochen, C. (2011). Non-Visual Effects of Light on Melatonin, Alertness and Cognitive Performance: Can Blue-Enriched Light Keep Us Alert? *PLoS ONE*, 6(1), e16429. <https://doi.org/10.1371/journal.pone.0016429>
- Chou, C., Lu, C.-C., & Huang, R. (2016). Effects of different ambient environments on human responses and work performance. *Journal of Ambient Intelligence and Humanized Computing*, 7(6), 865–874. <https://doi.org/10.1007/s12652-016-0393-0>
- Chraïbi, S., Creemers, P., Rosenkötter, C., van Loenen, E. J., Aries, M. B. C., & Rosemann, A. L. P. (2018). Dimming strategies for open office lighting: User experience and acceptance. *Lighting Research and Technology*, 1–17. <https://doi.org/10.1177/1477153518772154>
- Conover, W. J. (1999). *Practical nonparametric statistics*. Wiley. Retrieved from <https://www.wiley.com/en-us/Practical+Nonparametric+Statistics,+3rd+Edition-p-9780471160687>
- de Bakker, C., Aarts, M., Kort, H., & Rosemann, A. (2018). The feasibility of highly granular lighting control in open-plan offices: Exploring the comfort and energy saving potential. *Building and Environment*, 142(May), 427–438. <https://doi.org/10.1016/j.buildenv.2018.06.043>

- de Korte, E. M., Spiekman, M., Hoes-van Oeffelen, L., van der Zande, B., Vissenberg, G., Huiskes, G., & Kuijt-Evers, L. F. M. (2015). Personal environmental control: Effects of pre-set conditions for heating and lighting on personal settings, task performance and comfort experience. *Building and Environment*, 86, 166–176. <https://doi.org/10.1016/J.BUILDENV.2015.01.002>
- Delaney, D. T., O'hare, G. M. P., & Ruzzelli, A. G. (2009). *Evaluation of Energy-Efficiency in Lighting Systems using Sensor Networks*. Retrieved from [http://delivery.acm.org/10.1145/1820000/1810293/p61-delaney.pdf?ip=144.122.89.63&id=1810293&acc=ACTIVE\\_SERVICE&key=956257EA1AE17323.68BFDEAD37B6DC15.4D4702B0C3E38B35.4D4702B0C3E38B35&\\_\\_acm\\_\\_=1546183612\\_289d6e28420a0ea4a526cf681c16dd92](http://delivery.acm.org/10.1145/1820000/1810293/p61-delaney.pdf?ip=144.122.89.63&id=1810293&acc=ACTIVE_SERVICE&key=956257EA1AE17323.68BFDEAD37B6DC15.4D4702B0C3E38B35.4D4702B0C3E38B35&__acm__=1546183612_289d6e28420a0ea4a526cf681c16dd92)
- DiLouie, C. (2005). *Advanced Lighting Controls: Energy Savings, Productivity, Technology and Applications*. The Fairmont Press.
- DiLouie, C. (2008). *Lighting controls handbook*. Fairmont Press. Retrieved from [https://books.google.com.tr/books?id=3pKVF4HoeMIC&dq=lighting+controls+handbook&lr=&source=gbs\\_navlinks\\_s](https://books.google.com.tr/books?id=3pKVF4HoeMIC&dq=lighting+controls+handbook&lr=&source=gbs_navlinks_s)
- DOE. (2016). *Occupancy Sensor Lighting Energy Savings 2 Wireless Occupancy Sensors for Lighting Controls: An Applications Guide for Federal Facility Managers*. Retrieved from [https://www.energy.gov/sites/prod/files/2017/01/f34/wireless\\_occupancy\\_sensor\\_guide.pdf](https://www.energy.gov/sites/prod/files/2017/01/f34/wireless_occupancy_sensor_guide.pdf)
- Eklund, N. H., & Boyce, P. R. (1996). The development of a reliable, valid, and simple office lighting survey. *Journal of the Illuminating Engineering Society*, 25(2), 25–40. <https://doi.org/10.1080/00994480.1996.10748145>
- Galasiu, A. D., & Veitch, J. A. (2006). Occupant preferences and satisfaction with the luminous environment and control systems in daylit offices: a literature review. *Energy and Buildings*, 38(7), 728–742. <https://doi.org/10.1016/j.enbuild.2006.03.001>
- Garg, V., & Bansal, N. K. (2000). Smart occupancy sensors to reduce energy consumption. *Energy and Buildings*, 32(1), 81–87. [https://doi.org/10.1016/S0378-7788\(99\)00040-7](https://doi.org/10.1016/S0378-7788(99)00040-7)

- Guo, X., Tiller, D., Henze, G., & Waters, C. (2010a). The performance of occupancy-based lighting control systems: A review. *Lighting Research and Technology*, 42(4), 415–431. <https://doi.org/10.1177/1477153510376225>
- Guo, X., Tiller, D., Henze, G., & Waters, C. (2010b). The performance of occupancy-based lighting control systems: A review. *Lighting Research and Technology*, 42(4), 415–431. <https://doi.org/10.1177/1477153510376225>
- Hair, J. F., Black, W. C., Babin, B. J., & Anderson, R. E. (2014). *Pearson New International Edition: Multivariate Data Analysis. Exploratory Data Analysis in Business and Economics*. [https://doi.org/10.1007/978-3-319-01517-0\\_3](https://doi.org/10.1007/978-3-319-01517-0_3)
- Haq, M. A. U., Hassan, M. Y., Abdullah, H., Rahman, H. A., Abdullah, M. P., Hussin, F., & Said, D. M. (2014). A review on lighting control technologies in commercial buildings, their performance and affecting factors. *Renewable and Sustainable Energy Reviews*, 33, 268–279. <https://doi.org/10.1016/j.rser.2014.01.090>
- Haq, M. A. ul, Hassan, M. Y., Abdullah, H., Rahman, H. A., Abdullah, M. P., Hussin, F., & Said, D. M. (2014). A review on lighting control technologies in commercial buildings, their performance and affecting factors. *Renewable and Sustainable Energy Reviews*, 33, 268–279. <https://doi.org/10.1016/J.RSER.2014.01.090>
- IESNA. (2000). *IESNA Lighting Handbook Ninth Edition*. (J. Block, Ed.), *Journal of Experimental Psychology: General* (9th ed., Vol. 136). New York: IESNA.
- Karlen, M., & Benya, J. R. (2012). *Lighting Design Basics*. New Jersey: John Wiley & Sons, Inc.
- Krueger, R. A., & Casey, M. A. (2000). *A practical guide for applied research*.
- Leephakpreeda, T. (2005). Adaptive occupancy-based lighting control via Grey prediction. *Building and Environment*, 40(7), 881–886. <https://doi.org/10.1016/j.buildenv.2004.08.026>

- Maslow, A. H. (1943). A Theory of Human Motivation. *Psychological Review*, 50(4), 27. <https://doi.org/10.1037/h0054346>
- Moore, F. (1993). *Environmental control systems : heating cooling lighting*. (B. J. Clark, Ed.) (1st ed.). Singapore: McGraw-Hill. Retrieved from <http://eresources.nlb.gov.sg/printheritage/detail/3deb167c-38a5-473f-8f42-e2315652082b.aspx>
- Nagy, Z., Yong, F. Y., Frei, M., & Schlueter, A. (2015). Occupant centered lighting control for comfort and energy efficient building operation. *Energy & Buildings*, 94, 100–108. <https://doi.org/10.1016/j.enbuild.2015.02.053>
- Pandharipande, A., & Caicedo, D. (2015). Smart indoor lighting systems with luminaire-based sensing: A review of lighting control approaches. *Energy and Buildings*, 104, 369–377. <https://doi.org/10.1016/j.enbuild.2015.07.035>
- Pandharipande, A., & Newsham, G. (2018). Lighting controls: Evolution and revolution. *Lighting Research & Technology*, 50(1), 115–128. <https://doi.org/10.1177/1477153517731909>
- Park, J. Y., Dougherty, T., Fritz, H., & Nagy, Z. (2019). LightLearn: An adaptive and occupant centered controller for lighting based on reinforcement learning. *Building and Environment*, 147, 397–414. <https://doi.org/10.1016/j.buildenv.2018.10.028>
- Richman, E. E., Dittmer, A. L., & Keller, J. M. (1996). Field analysis of occupancy sensor operation: Parameters affecting lighting energy savings. *Journal of the Illuminating Engineering Society*, 25(1), 83–92. <https://doi.org/10.1080/00994480.1996.10748136>
- Rundquist, R. A., McDougall, T. G., & Benya, J. (1996). *Lighting Controls: Patterns for Design* (Vol. EPRI TR-10).
- Schutz, R. W., & Gessaroli, M. E. (1987). The Analysis of Repeated Measures Designs Involving Multiple Dependent Variables. *Research Quarterly for Exercise and Sport*, 58(2), 132–149. <https://doi.org/10.1080/02701367.1987.10605437>

- Shen, E., Hu, J., & Patel, M. (2014). Energy and visual comfort analysis of lighting and daylight control strategies. *Building and Environment*, 78, 155–170.  
<https://doi.org/10.1016/J.BUILDENV.2014.04.028>
- Stiller, M. (2013). *Quality Lighting for High Performance Buildings* (1st ed.). Lilburn: Lulu Press Inc. Retrieved from  
[https://books.google.com.tr/books?id=8sFOCAAAQBAJ&dq=quality+lighting+for+high+performance+building&lr=&source=gbs\\_navlinks\\_s](https://books.google.com.tr/books?id=8sFOCAAAQBAJ&dq=quality+lighting+for+high+performance+building&lr=&source=gbs_navlinks_s)
- Tan, F., Caicedo, D., Pandharipande, A., & Zuniga, M. (2018). Sensor-driven, human-in-the-loop lighting control. *Lighting Research and Technology*, 50(5), 660–680. <https://doi.org/10.1177/1477153517693887>
- van Bommel, W., & van den Beld, G. (2004). Lighting for work: a review of visual and biological effects. *Lighting Research & Technology*, 36(4), 255–266.  
<https://doi.org/10.1191/1365782804li122oa>
- Vimalanathan, K., & Babu, T. R. (n.d.). The effect of indoor office environment on the work performance, health and well-being of office workers.  
<https://doi.org/10.1186/s40201-014-0113-7>
- Walerczyk, S. (2014). *Lighting and Controls : Transitioning to the Future* (1st ed.). Lilburn: Georgia:Fairmont Press. Retrieved from  
<http://search.ebscohost.com/login.aspx?direct=true&AuthType=ip&db=nlebk&AN=777846&site=eds-live&authtype=ip,uid>
- Wang, S. (2010). *Intelligent Buildings and Building Automation* (1st ed.). New York: Spon Press. Retrieved from  
[https://books.google.com.tr/books/about/Intelligent\\_Buildings\\_and\\_Building\\_Autom.html?id=4C58AgAAQBAJ&printsec=frontcover&source=kp\\_read\\_button&redir\\_esc=y#v=onepage&q&f=false](https://books.google.com.tr/books/about/Intelligent_Buildings_and_Building_Autom.html?id=4C58AgAAQBAJ&printsec=frontcover&source=kp_read_button&redir_esc=y#v=onepage&q&f=false)
- Wen, Y. J., & Agogino, A. M. (2008). Wireless networked lighting systems for optimizing energy savings and user satisfaction. *2008 IEEE Wireless Hive Networks Conference Proceedings, WHNC*.  
<https://doi.org/10.1109/WHNC.2008.4629493>

Williams, A., Atkinson, B., Garbesi, K., Page, E., & Rubinstein, F. (2012). Lighting controls in commercial buildings. *LEUKOS - Journal of Illuminating Engineering Society of North America*, 8(3), 161–180.  
<https://doi.org/10.1582/LEUKOS.2012.08.03.001>

Winchip, S. M. (2011). *Fundamentals of Lighting*. (R. Kontzias, Olga T.; Phelps, Ed.) (2nd ed.). Fairchild Publications, Inc.

YEGM. (2018). *Kamu Binalarında Enerji Verimliliği Etüdü*. Retrieved from [http://www.yegm.gov.tr/document/KamuBinalariRaporu\\_2018.pdf](http://www.yegm.gov.tr/document/KamuBinalariRaporu_2018.pdf)





## APPENDICES

### A. Detailed Information on the Participants

| Participant No | Age | Gender | Familiarity (years) |
|----------------|-----|--------|---------------------|
| P1             | 29  | K      | 10                  |
| P2             | 29  | E      | 10                  |
| P3             | 26  | K      | 7                   |
| P4             | 18  | E      | 1                   |
| P5             | 23  | K      | 4                   |
| P6             | 23  | E      | 4                   |
| P7             | 22  | K      | 3                   |
| P8             | 19  | K      | 1                   |
| P9             | 19  | K      | 1                   |
| P10            | 27  | K      | 8                   |
| P11            | 21  | E      | 2                   |
| P12            | 23  | K      | 4                   |
| P13            | 22  | E      | 3                   |
| P14            | 22  | E      | 3                   |
| P15            | 29  | K      | 10                  |
| P16            | 28  | K      | 9                   |
| P17            | 22  | E      | 3                   |
| P18            | 22  | E      | 3                   |
| P19            | 24  | K      | 5                   |

| Participant No | Age | Gender | Familiarity (years) |
|----------------|-----|--------|---------------------|
| P20            | 24  | E      | 4                   |
| P21            | 23  | E      | 3                   |
| P22            | 22  | E      | 2                   |
| P23            | 26  | E      | 1                   |
| P24            | 23  | E      | 4                   |
| P25            | 23  | E      | 4                   |
| P26            | 27  | E      | 8                   |
| P27            | 22  | E      | 5                   |
| P28            | 20  | K      | 2                   |
| P29            | 22  | K      | 2                   |
| P30            | 22  | K      | 2                   |
| P31            | 26  | E      | 2                   |
| P32            | 27  | E      | 1                   |
| P33            | 24  | K      | 3                   |
| P34            | 25  | E      | 4                   |
| P35            | 23  | E      | 4                   |
| P36            | 27  | K      | 1                   |
| P37            | 26  | E      | 1                   |
| P38            | 27  | E      | 2                   |

## B. Consent Participation Form

### ARAŞTIRMAYA GÖNÜLLÜ KATILIM FORMU

Bu araştırma, ODTÜ Fen Bilimleri Enstitüsü, Yapı Bilimleri alanında Dr. Öğr. Üyesi M. Koray PEKERİÇLİ danışmanlığında ve Özge KARAMAN tarafından yürütülen yüksek lisans tezi kapsamında yapılmaktadır. Bu form sizi araştırma koşulları hakkında bilgilendirmek için hazırlanmıştır.

#### Çalışmanın Amacı Nedir?

Çalışmanın amacı, 7/24 kullanılan binaların dolaşım alanlarında karanlık saatlerde kullanıcı konforu ve memnuniyetine etki eden etmenlerin ortaya konulması, bu tarz bir bina olan ODTÜ Mimarlık Fakültesinin mevcut haliyle kullanıcı memnuniyeti değerlendirilmesinin yapılması, kullanıcı kabulü ve sensör tabanlı aydınlatma kontrol sistemlerinin konfigürasyonu arasındaki ilişkinin ortaya konması, enerji verimliliği ve kullanıcı konforu arasında optimum çözümün belirlenmesidir.

#### Bize Nasıl Yardımcı Olmanızı İsteyeceğiz?

Araştırmaya katılmayı kabul ederseniz, sizden beklenen, Mimarlık Fakültesi'nin şuanki durumunu 5 dakika sürecek bir anket ile değerlendirmenizdir. Daha sonra belirlenen saatte ODTÜ Mimarlık Fakültesi'ne gelerek hazırladığımız deney ortamında 6 farklı sensör tabanlı aydınlatma kontrol sistemini deneyimleyerek her aşamada 2 dakika sürecek bir deneyimde bulunmanızdır. Bu araştırma toplam 20 dakika sürecektir.

#### Sizden Topladığımız Bilgileri Nasıl Kullanacağız?

Araştırmaya katılımınız tamamen gönüllülük temelinde olmalıdır. Çalışmada, sizden kimlik veya kurum belirleyici hiçbir bilgi istenmemektedir. Kimliğiniz tamamıyla gizli tutulacak, sağladığınız veriler sadece araştırmacılar tarafından değerlendirilecektir. Katılımcılardan elde edilecek bilgiler toplu halde değerlendirilecek ve bilimsel yayınlarda kullanılacaktır. Sağladığınız veriler gönüllü katılım formlarında toplanan kimlik bilgileri ile eşleştirilmeyecektir.

#### Katılımınızla ilgili bilmeniz gerekenler:

Anket ve değerlendirme soruları, kişisel rahatsızlık verecek sorular içermemektedir. Hazırlanan deney düzeneği herhangi bir risk içermemektedir. Ancak, katılım sırasında sorulardan ya da herhangi başka bir nedenden ötürü kendinizi rahatsız hissederseniz cevaplamaı yarıda kesmek konusunda serbestsiniz. Böyle bir durumda çalışmayı uygulayan kişiye, çalışmayı tamamlamak istemediğinizi söylemek yeterli olacaktır.

#### Araştırmayla ilgili daha fazla bilgi almak isterseniz:

Araştırmanın amacı önceden sizinle paylaşılmıştır. Öncesinde ve sonrasında araştırmayla ilgili sorularınızı sorabilirsiniz. Bu çalışmaya katıldığınız için şimdiden teşekkür ederiz. Çalışma hakkında daha fazla bilgi almak isterseniz Özge Karaman ([ozgkaraman@gmail.com](mailto:ozgkaraman@gmail.com)) ile iletişim kurabilirsiniz.

**Yukarıdaki bilgileri okudum ve bu çalışmaya tamamen gönüllü olarak katılıyorum.**

(Formu doldurup imzaladıktan sonra uygulayıcıya geri veriniz).

İsim Soyad

Tarih

İmza

## C. Evaluation Questionnaire Form (in original language)

### Deney Ortamı Aydınlatma Kontrolü Değerlendirme Formu

#### SENARYO:

1. Lütfen aşağıdaki kriterleri deneyin başladığı noktadan bittiği noktaya kadar olan kişisel deneyimlerinizi göz önünde bulundurarak değerlendiriniz.

|  | 1 Kesinlikle katılmıyorum | 2                     | 3                     | 4                     | 5                     | 6                     | 7 Kesinlikle katılıyorum |
|--|---------------------------|-----------------------|-----------------------|-----------------------|-----------------------|-----------------------|--------------------------|
| Bina girişinin davetkar görüldüğünü düşündüm.              | <input type="radio"/>     | <input type="radio"/> | <input type="radio"/> | <input type="radio"/> | <input type="radio"/> | <input type="radio"/> | <input type="radio"/>    |
| Binaya girmeden önce kendimi tedirgin hissettim.           | <input type="radio"/>     | <input type="radio"/> | <input type="radio"/> | <input type="radio"/> | <input type="radio"/> | <input type="radio"/> | <input type="radio"/>    |
| Binaya girdikten sonra kendimi iyi hissettim.              | <input type="radio"/>     | <input type="radio"/> | <input type="radio"/> | <input type="radio"/> | <input type="radio"/> | <input type="radio"/> | <input type="radio"/>    |
| Koridorda ilerlerken etrafımı rahat bir şekilde algıladım. | <input type="radio"/>     | <input type="radio"/> | <input type="radio"/> | <input type="radio"/> | <input type="radio"/> | <input type="radio"/> | <input type="radio"/>    |
| Görüş alanımdaki mekanlar beni tedirgin etti.              | <input type="radio"/>     | <input type="radio"/> | <input type="radio"/> | <input type="radio"/> | <input type="radio"/> | <input type="radio"/> | <input type="radio"/>    |
| Atmosfer beni rahat hissettirdi.                           | <input type="radio"/>     | <input type="radio"/> | <input type="radio"/> | <input type="radio"/> | <input type="radio"/> | <input type="radio"/> | <input type="radio"/>    |
| Merdivenleri zamanında algıladım.                          | <input type="radio"/>     | <input type="radio"/> | <input type="radio"/> | <input type="radio"/> | <input type="radio"/> | <input type="radio"/> | <input type="radio"/>    |
| Genel olarak bu aydınlatma kontrolünden memnun kaldım.     | <input type="radio"/>     | <input type="radio"/> | <input type="radio"/> | <input type="radio"/> | <input type="radio"/> | <input type="radio"/> | <input type="radio"/>    |
| Bu aydınlatma kontrolü benim için kabul edilebilirdi.      | <input type="radio"/>     | <input type="radio"/> | <input type="radio"/> | <input type="radio"/> | <input type="radio"/> | <input type="radio"/> | <input type="radio"/>    |
| Bu aydınlatma kontrolü güven vericiydi.                    | <input type="radio"/>     | <input type="radio"/> | <input type="radio"/> | <input type="radio"/> | <input type="radio"/> | <input type="radio"/> | <input type="radio"/>    |

#### D. Results of the Friedman Test for 'Overall Satisfaction Score' (SPSS Output)

##### Hypothesis Test Summary

|   | Null Hypothesis  | Test   | Sig. | Decision                    |
|---|--|--|------|-----------------------------|
| 1 | The distributions of OverallScore_A, OverallScore_B, OverallScore_C and OverallScore_D are the same. | Related-Samples Friedman's Two-Way Analysis of Variance by Ranks | .000 | Reject the null hypothesis. |

Asymptotic significances are displayed. The significance level is .05.

|                                       |        |
|---------------------------------------|--------|
| <b>Total N</b>                        | 37     |
| <b>Test Statistic</b>                 | 47.810 |
| <b>Degrees of Freedom</b>             | 3      |
| <b>Asymptotic Sig. (2-sided test)</b> | .000   |

| Sample1-Sample2               | Test Statistic | Std. Error | Std. Test Statistic | Sig. | Adj.Sig. |
|-------------------------------|----------------|------------|---------------------|------|----------|
| OverallScore_B-OverallScore_D | -1.392         | .300       | -4.637              | .000 | .000     |
| OverallScore_B-OverallScore_A | 1.716          | .300       | 5.718               | .000 | .000     |
| OverallScore_B-OverallScore_C | -1.811         | .300       | -6.033              | .000 | .000     |
| OverallScore_D-OverallScore_A | .324           | .300       | 1.081               | .280 | 1.000    |
| OverallScore_D-OverallScore_C | .419           | .300       | 1.396               | .163 | .977     |
| OverallScore_A-OverallScore_C | -.095          | .300       | -.315               | .753 | 1.000    |

Each row tests the null hypothesis that the Sample 1 and Sample 2 distributions are the same. Asymptotic significances (2-sided tests) are displayed. The significance level is .05.

**E. Results of the Friedman Test for 'Evaluation Criteria' (SPSS Output)**

**Hypothesis Test Summary**

|   | Null Hypothesis                                      | Test   | Sig. | Decision                    |
|---|--|--|------|-----------------------------|
| 1 | The distributions of A1, B1, C1 and D1 are the same. | Related-Samples Friedman's Two-Way Analysis of Variance by Ranks | .000 | Reject the null hypothesis. |

Asymptotic significances are displayed. The significance level is .05.

|                                       |        |
|---------------------------------------|--------|
| <b>Total N</b>                        | 37     |
| <b>Test Statistic</b>                 | 49.020 |
| <b>Degrees of Freedom</b>             | 3      |
| <b>Asymptotic Sig. (2-sided test)</b> | .000   |

Each node shows the sample average rank.

| Sample1-Sample2 | Test Statistic | Std. Error | Std. Test Statistic | Sig. | Adj.Sig. |
|-----------------|----------------|------------|---------------------|------|----------|
| B1-D1           | -1.365         | .300       | -4.547              | .000 | .000     |
| B1-C1           | -1.419         | .300       | -4.727              | .000 | .000     |
| B1-A1           | 1.757          | .300       | 5.853               | .000 | .000     |
| D1-C1           | .054           | .300       | .180                | .857 | 1.000    |
| D1-A1           | .392           | .300       | 1.306               | .192 | 1.000    |
| C1-A1           | .338           | .300       | 1.126               | .260 | 1.000    |

Each row tests the null hypothesis that the Sample 1 and Sample 2 distributions are the same. Asymptotic significances (2-sided tests) are displayed. The significance level is .05.

### Hypothesis Test Summary

|   | Null Hypothesis                                      | Test   | Sig. | Decision                    |
|---|--|--|------|-----------------------------|
| 1 | The distributions of A3, B3, C3 and D3 are the same. | Related-Samples Friedman's Two-Way Analysis of Variance by Ranks | .000 | Reject the null hypothesis. |

Asymptotic significances are displayed. The significance level is .05.

|                                       |        |
|---------------------------------------|--------|
| <b>Total N</b>                        | 37     |
| <b>Test Statistic</b>                 | 45.807 |
| <b>Degrees of Freedom</b>             | 3      |
| <b>Asymptotic Sig. (2-sided test)</b> | .000   |

| Sample1-Sample2            | Test Statistic | Std. Error | Std. Test Statistic | Sig. | Adj.Sig. |
|----------------------------|----------------|------------|---------------------|------|----------|
| <b>B2recoded-D2recoded</b> | -1.014         | .300       | -3.377              | .001 | .004     |
| <b>B2recoded-C2recoded</b> | -1.243         | .300       | -4.142              | .000 | .000     |
| <b>B2recoded-A2recoded</b> | 1.689          | .300       | 5.628               | .000 | .000     |
| <b>D2recoded-C2recoded</b> | .230           | .300       | .765                | .444 | 1.000    |
| <b>D2recoded-A2recoded</b> | .676           | .300       | 2.251               | .024 | .146     |
| <b>C2recoded-A2recoded</b> | .446           | .300       | 1.486               | .137 | .824     |

Each row tests the null hypothesis that the Sample 1 and Sample 2 distributions are the same.  
Asymptotic significances (2-sided tests) are displayed. The significance level is .05.

### Hypothesis Test Summary

|   | Null Hypothesis                                      | Test   | Sig. | Decision                    |
|---|--|--|------|-----------------------------|
| 1 | The distributions of A4, B4, C4 and D4 are the same. | Related-Samples Friedman's Two-Way Analysis of Variance by Ranks | .000 | Reject the null hypothesis. |

Asymptotic significances are displayed. The significance level is .05.

|                                       |        |
|---------------------------------------|--------|
| <b>Total N</b>                        | 37     |
| <b>Test Statistic</b>                 | 22.215 |
| <b>Degrees of Freedom</b>             | 3      |
| <b>Asymptotic Sig. (2-sided test)</b> | .000   |

| Sample1-Sample2 | Test Statistic | Std. Error | Std. Test Statistic | Sig. | Adj.Sig. |
|-----------------|----------------|------------|---------------------|------|----------|
| B3-A3           | .351           | .300       | 1.171               | .242 | 1.000    |
| B3-D3           | -.919          | .300       | -3.062              | .002 | .013     |
| B3-C3           | -1.108         | .300       | -3.692              | .000 | .001     |
| A3-D3           | -.568          | .300       | -1.891              | .059 | .352     |
| A3-C3           | -.757          | .300       | -2.521              | .012 | .070     |
| D3-C3           | .189           | .300       | .630                | .528 | 1.000    |

Each row tests the null hypothesis that the Sample 1 and Sample 2 distributions are the same. Asymptotic significances (2-sided tests) are displayed. The significance level is .05.

### Hypothesis Test Summary

|   | Null Hypothesis                                      | Test   | Sig. | Decision                    |
|---|--|--|------|-----------------------------|
| 1 | The distributions of A4, B4, C4 and D4 are the same. | Related-Samples Friedman's Two-Way Analysis of Variance by Ranks | .000 | Reject the null hypothesis. |

Asymptotic significances are displayed. The significance level is .05.

|                                       |        |
|---------------------------------------|--------|
| <b>Total N</b>                        | 37     |
| <b>Test Statistic</b>                 | 34.369 |
| <b>Degrees of Freedom</b>             | 3      |
| <b>Asymptotic Sig. (2-sided test)</b> | .000   |

| Sample1-Sample2 | Test Statistic | Std. Error | Std. Test Statistic | Sig. | Adj.Sig. |
|-----------------|----------------|------------|---------------------|------|----------|
| B4-D4           | -1.027         | .300       | -3.422              | .001 | .004     |
| B4-C4           | -1.257         | .300       | -4.187              | .000 | .000     |
| B4-A4           | 1.284          | .300       | 4.277               | .000 | .000     |
| D4-C4           | .230           | .300       | .765                | .444 | 1.000    |
| D4-A4           | .257           | .300       | .855                | .392 | 1.000    |
| C4-A4           | .027           | .300       | .090                | .928 | 1.000    |

Each row tests the null hypothesis that the Sample 1 and Sample 2 distributions are the same. Asymptotic significances (2-sided tests) are displayed. The significance level is .05.

### Hypothesis Test Summary

|   | Null Hypothesis  | Test   | Sig. | Decision                    |
|---|--|--|------|-----------------------------|
| 1 | The distributions of A5recoded, B5recoded, C5recoded and D5recoded are the same. | Related-Samples Friedman's Two-Way Analysis of Variance by Ranks | .000 | Reject the null hypothesis. |

Asymptotic significances are displayed. The significance level is .05.

|                                       |        |
|---------------------------------------|--------|
| <b>Total N</b>                        | 37     |
| <b>Test Statistic</b>                 | 37.312 |
| <b>Degrees of Freedom</b>             | 3      |
| <b>Asymptotic Sig. (2-sided test)</b> | .000   |

| Sample1-Sample2            | Test Statistic | Std. Error | Std. Test Statistic | Sig. | Adj. Sig. |
|----------------------------|----------------|------------|---------------------|------|-----------|
| <b>B5recoded-D5recoded</b> | -0.892         | .300       | -2.971              | .003 | .018      |
| <b>B5recoded-C5recoded</b> | -1.311         | .300       | -4.367              | .000 | .000      |
| <b>B5recoded-A5recoded</b> | 1.365          | .300       | 4.547               | .000 | .000      |
| <b>D5recoded-C5recoded</b> | .419           | .300       | 1.396               | .163 | .977      |
| <b>D5recoded-A5recoded</b> | .473           | .300       | 1.576               | .115 | .690      |
| <b>C5recoded-A5recoded</b> | .054           | .300       | .180                | .857 | 1.000     |

Each row tests the null hypothesis that the Sample 1 and Sample 2 distributions are the same. Asymptotic significances (2-sided tests) are displayed. The significance level is .05.

### Hypothesis Test Summary

|   | Null Hypothesis                                      | Test   | Sig. | Decision                    |
|---|--|--|------|-----------------------------|
| 1 | The distributions of A6, B6, C6 and D6 are the same. | Related-Samples Friedman's Two-Way Analysis of Variance by Ranks | .000 | Reject the null hypothesis. |

Asymptotic significances are displayed. The significance level is .05.

|                                       |        |
|---------------------------------------|--------|
| <b>Total N</b>                        | 37     |
| <b>Test Statistic</b>                 | 36.237 |
| <b>Degrees of Freedom</b>             | 3      |
| <b>Asymptotic Sig. (2-sided test)</b> | .000   |

| Sample1-Sample2 | Test Statistic | Std. Error | Std. Test Statistic | Sig. | Adj.Sig. |
|-----------------|----------------|------------|---------------------|------|----------|
| B6-A6           | 1.068          | .300       | 3.557               | .000 | .002     |
| B6-D6           | -1.392         | .300       | -4.637              | .000 | .000     |
| B6-C6           | -1.486         | .300       | -4.952              | .000 | .000     |
| A6-D6           | -.324          | .300       | -1.081              | .280 | 1.000    |
| A6-C6           | -.419          | .300       | -1.396              | .163 | .977     |
| D6-C6           | .095           | .300       | .315                | .753 | 1.000    |

Each row tests the null hypothesis that the Sample 1 and Sample 2 distributions are the same. Asymptotic significances (2-sided tests) are displayed. The significance level is .05.

### Hypothesis Test Summary

|   | Null Hypothesis                                      | Test   | Sig. | Decision                    |
|---|--|--|------|-----------------------------|
| 1 | The distributions of A7, B7, C7 and D7 are the same. | Related-Samples Friedman's Two-Way Analysis of Variance by Ranks | .000 | Reject the null hypothesis. |

Asymptotic significances are displayed. The significance level is .05.

|                                       |        |
|---------------------------------------|--------|
| <b>Total N</b>                        | 37     |
| <b>Test Statistic</b>                 | 57.023 |
| <b>Degrees of Freedom</b>             | 3      |
| <b>Asymptotic Sig. (2-sided test)</b> | .000   |

| Sample1-Sample2 | Test Statistic | Std. Error | Std. Test Statistic | Sig. | Adj.Sig. |
|-----------------|----------------|------------|---------------------|------|----------|
| <b>B7-D7</b>    | -1.351         | .300       | -4.502              | .000 | .000     |
| <b>B7-A7</b>    | 1.527          | .300       | 5.088               | .000 | .000     |
| <b>B7-C7</b>    | -1.716         | .300       | -5.718              | .000 | .000     |
| <b>D7-A7</b>    | .176           | .300       | .585                | .558 | 1.000    |
| <b>D7-C7</b>    | .365           | .300       | 1.216               | .224 | 1.000    |
| <b>A7-C7</b>    | -.189          | .300       | -.630               | .528 | 1.000    |

Each row tests the null hypothesis that the Sample 1 and Sample 2 distributions are the same. Asymptotic significances (2-sided tests) are displayed. The significance level is .05.

### Hypothesis Test Summary

|   | Null Hypothesis                                      | Test   | Sig. | Decision                    |
|---|--|--|------|-----------------------------|
| 1 | The distributions of A8, B8, C8 and D8 are the same. | Related-Samples Friedman's Two-Way Analysis of Variance by Ranks | .000 | Reject the null hypothesis. |

Asymptotic significances are displayed. The significance level is .05.

|                                       |        |
|---------------------------------------|--------|
| <b>Total N</b>                        | 37     |
| <b>Test Statistic</b>                 | 57.023 |
| <b>Degrees of Freedom</b>             | 3      |
| <b>Asymptotic Sig. (2-sided test)</b> | .000   |

| Sample1-Sample2 | Test Statistic | Std. Error | Std. Test Statistic | Sig. | Adj.Sig. |
|-----------------|----------------|------------|---------------------|------|----------|
| B8-A8           | 1.243          | .300       | 4.142               | .000 | .000     |
| B8-D8           | -1.311         | .300       | -4.367              | .000 | .000     |
| B8-C8           | -1.554         | .300       | -5.178              | .000 | .000     |
| A8-D8           | -.068          | .300       | -.225               | .822 | 1.000    |
| A8-C8           | -.311          | .300       | -1.036              | .300 | 1.000    |
| D8-C8           | .243           | .300       | .810                | .418 | 1.000    |

Each row tests the null hypothesis that the Sample 1 and Sample 2 distributions are the same. Asymptotic significances (2-sided tests) are displayed. The significance level is .05.

### Hypothesis Test Summary

|   | Null Hypothesis                                      | Test   | Sig. | Decision                    |
|---|--|--|------|-----------------------------|
| 1 | The distributions of A9, B9, C9 and D9 are the same. | Related-Samples Friedman's Two-Way Analysis of Variance by Ranks | .000 | Reject the null hypothesis. |

Asymptotic significances are displayed. The significance level is .05.

|                                |        |
|--------------------------------|--------|
| Total N                        | 37     |
| Test Statistic                 | 39.059 |
| Degrees of Freedom             | 3      |
| Asymptotic Sig. (2-sided test) | .000   |

| Sample1-Sample2 | Test Statistic | Std. Error | Std. Test Statistic | Sig. | Adj.Sig. |
|-----------------|----------------|------------|---------------------|------|----------|
| B8-A8           | 1.243          | .300       | 4.142               | .000 | .000     |
| B8-D8           | -1.311         | .300       | -4.367              | .000 | .000     |
| B8-C8           | -1.554         | .300       | -5.178              | .000 | .000     |
| A8-D8           | -.068          | .300       | -.225               | .822 | 1.000    |
| A8-C8           | -.311          | .300       | -1.036              | .300 | 1.000    |
| D8-C8           | .243           | .300       | .810                | .418 | 1.000    |

Each row tests the null hypothesis that the Sample 1 and Sample 2 distributions are the same. Asymptotic significances (2-sided tests) are displayed. The significance level is .05.

### Hypothesis Test Summary

|   | Null Hypothesis  | Test   | Sig. | Decision                    |
|---|--|--|------|-----------------------------|
| 1 | The distributions of A10, B10, C10 and D10 are the same. | Related-Samples Friedman's Two-Way Analysis of Variance by Ranks | .000 | Reject the null hypothesis. |

Asymptotic significances are displayed. The significance level is .05.

|                                       |        |
|---------------------------------------|--------|
| <b>Total N</b>                        | 37     |
| <b>Test Statistic</b>                 | 56.929 |
| <b>Degrees of Freedom</b>             | 3      |
| <b>Asymptotic Sig. (2-sided test)</b> | .000   |

| Sample1-Sample2 | Test Statistic | Std. Error | Std. Test Statistic | Sig. | Adj. Sig. |
|-----------------|----------------|------------|---------------------|------|-----------|
| <b>B10-D10</b>  | -1.527         | .300       | -5.088              | .000 | .000      |
| <b>B10-A10</b>  | 1.662          | .300       | 5.538               | .000 | .000      |
| <b>B10-C10</b>  | -1.730         | .300       | -5.763              | .000 | .000      |
| <b>D10-A10</b>  | .135           | .300       | .450                | .653 | 1.000     |
| <b>D10-C10</b>  | .203           | .300       | .675                | .499 | 1.000     |
| <b>A10-C10</b>  | -.068          | .300       | -.225               | .822 | 1.000     |

Each row tests the null hypothesis that the Sample 1 and Sample 2 distributions are the same. Asymptotic significances (2-sided tests) are displayed. The significance level is .05.